

OPERATOR MANUAL

**Amsco® Century™
Medium Steam Sterilizer
26" x 26" (660 x 660 mm)**

• Scientific

(12/16/05)

P129373-635

A WORD FROM STERIS CORPORATION

This manual contains important information on proper use of the Amsco® Century™ Medium Steam Sterilizer 26" x 26" (660 x 660 mm). **All personnel involved in the use of this equipment must carefully review and comply with the warnings, cautions and instructions contained in this manual.** These instructions are important to protect the health and safety of personnel operating an Amsco Century Sterilizer and should be retained in a conveniently accessible area for quick reference.

This sterilizer is specifically designed to process goods using only the cycles as specified in this manual. If there is any doubt about a specific material or product, contact the manufacturer of the product for the recommended sterilization technique.

STERIS carries a complete line of accessories for use with this sterilizer to simplify, organize and assure sterility of the sterilization process. Instrument trays and biological/chemical monitoring systems are all available to fulfill your facility's processing needs. A STERIS representative will gladly review these with you.

Service Information

A thorough preventive maintenance program is essential to safe and proper sterilizer operation. Comprehensive instructions for routine preventive maintenance can be found in *Maintenance Manual, P-764330-117*, available separately.

You are encouraged to contact STERIS concerning our Preventive Maintenance Agreement. Under the terms of this agreement, preventive maintenance, adjustments, and replacement of worn parts are done on a scheduled basis to assure equipment performance at peak capability and to help avoid untimely or costly interruptions. STERIS maintains a nationwide staff of well equipped, factory-trained technicians to provide this service, as well as expert repair services. Please contact your STERIS representative for details.

Advisory

A summary of the safety precautions to be observed when operating or servicing this equipment can be found in Section 1 of this manual. Do not operate or service the sterilizer until you have become familiar with this information.

This sterilizer is not designed to process flammable liquids nor liquids in containers that are not designed for sterilization. Any alteration of the sterilizer which affects its operation will void the warranty and could violate state and local regulations and jeopardize insurance coverage.

Indications for Use

The Amsco Century Sliding-door Prevacuum Steam Sterilizer is designed for efficient, sterilization of non-porous and porous, heat and moisture-stable materials. The Amsco Century Steam Sterilizer is available in the following configurations:

- 26" x 26" x 26" (660 x 660 x 660 mm)
- 26" x 36" x 39" (660 x 660 x 990 mm)
- 26" x 26" x 49" (660 x 660 x 1245 mm)
- 26" x 26" x 61" (660 x 660 x 1549 mm)

The Amsco Century Medium Steam Sterilizer is equipped with the following default cycles and cycle values (see *SECTION 8* for detailed cycle parameters and instructions for modifying cycle parameters).

CYCLES	RECOMMENDED LOADS	STERILIZE TEMP.	STERILIZE TIME	DRY TIME
PREVACUUM	Heat and moisture stabile materials utilizing vacuum-assisted air removal process.	132°C (270°F)	4 minutes	5 minutes
GRAVITY	Heat and moisture stabile materials	132°C (270°F)	15 minutes	5 minutes
LIQUIDS	Liquids and media in vented borosilicate glass containers.	121°C (250°F)	45 minutes	N/A

CE EC Authorized Representative

STERIS Ltd.
 STERIS House
 Jays Close
 Viables
 Basingstoke
 Hampshire
 RG22 4AX
 UNITED KINGDOM
 Tel: +44 (0)1256 840400
 Fax: +44 (0) 1256 866502

Manufactured by:
 STERIS Corporation
 2424 West 23rd Street
 Erie, PA 16506 • USA
 TEL: 814 452 3100
 FAX: 814 870 8338

**STERIS Corporation,
 Erie, Pennsylvania is an
 ISO 13485 certified facility.**

**The base language of this document is
 ENGLISH. Any translations must be
 made from the base language document.**

TABLE OF CONTENTS

Section	Description	Page
1	LISTING OF WARNINGS AND CAUTIONS.....	1-1
1.1	Definition of Symbols	1-4
2	INSTALLATION VERIFICATION	2-1
2.1	Installation Checklist	2-1
2.1.1	Service Clearance	2-1
2.1.2	Plumbing Services	2-1
2.1.3	Electrical Service	2-2
2.1.4	Sterilizer Final Check	2-2
2.1.5	Cycle Operation	2-2
2.2	Technical Specifications	2-2
2.2.1	Overall Size	2-2
2.2.2	Weight	2-3
2.2.3	Utility Requirements	2-3
2.2.4	Environmental Conditions	2-3
3	TECHNIQUES OF STERILIZATION.....	3-1
3.1	General.....	3-1
3.2	Recommended Sterilization Variables	3-1
3.2.1	Prevacuum Cycle	3-1
3.2.2	Gravity Cycle	3-2
3.2.3	Liquid Cycle	3-2
3.3	Recommendations for Sterilizing Liquids	3-3
3.4	Recommendations for Enhancing the Sterilization Process	3-4
3.5	Control Measures For Verifying Sterilization Process	3-5
3.5.1	Biological Monitors	3-5
3.5.2	Testing for Prevacuum Efficiency	3-5
3.6	Dart (Bowie-Dick) Test.....	3-6
3.7	Vacuum Leak Test	3-6

Table of Contents (continued)

Section	Description	Page
4	COMPONENT IDENTIFICATION	4-1
4.1	Main Power Disconnect Switch	4-2
4.2	Supply Valves	4-2
4.3	Front Panel Controls, Display and Gauges	4-2
4.4	Emergency Stop Button	4-2
4.5	Control Panel	4-3
4.5.1	Touch Screen	4-3
4.5.2	Printer	4-4
4.6	Unload End Control Panel (Double Door Units)	4-5
4.7	Power Door Operation	4-6
4.8	Emergency Door Opening Procedure	4-7
5	CONTROL INTERFACE	5-1
5.1	General	5-1
5.2	Cycle Select Menus	5-2
5.2.1	Processing Cycles	5-2
5.2.2	Test Cycles	5-4
5.3	Out of Cycle Options Menus	5-5
6	STERILIZER OPERATION	6-1
6.1	Before Operating Sterilizer	6-1
6.2.2	Loading Car Instructions: Loading	6-3
6.2	Unloading the Sterilizer	6-3
6.2.2	Loading Car Instructions: Unloading	6-4
6.3	Prevacuum Cycle Operation	6-5
6.4	Gravity Cycle Operation	6-12
6.5	Liquid Cycle Operation	6-18
6.6	Leak Test Cycle Operation	6-23
6.7	DART Warmup Cycle Operation	6-26
6.8	DART Test Cycle Operation	6-29
6.9	Aborting Cycles	6-31
7	ENTERING ACCESS CODE	7-1
7.1	Sterilizer Usage Locked Out	7-1
7.2	Change Values Menu Locked Out	7-2

Table of Contents (continued)

Section	Description	Page
8	PROGRAMMING CYCLE VALUES	8-1
8.1	Access Cycle Menu–Change Cycle Values	8-2
8.2	Change Values Procedure	8-4
9	PROGRAMMING OPERATING PARAMETERS	9-1
9.1	Access Change Values Menu	9-1
9.2	Time/Date	9-2
9.3	Too Long In Phase	9-4
9.4	Setup	9-8
9.4.1	Temp/Pres Units	9-9
9.4.2	Audible Signals	9-12
9.4.3	Utility Shutdown	9-14
	Same Times For Each Weekday (Monday - Friday)	9-15
	Different Times For Each Weekday (Monday - Friday)	9-17
	Saturday or Sunday	9-19
9.4.5	Print Format	9-20
9.4.6	Duplicate Print	9-22
9.4.7	Turn Off Printer	9-23
10	OUT OF CYCLE OPTIONS	10-1
10.1	General	10-1
10.2	Status Print	10-2
10.4	Paper Feed	10-3
10.3	Duplicate Print	10-3
10.5	Change Values	10-4
10.6	Display Values	10-4
10.6.1	Cycles	10-5
10.6.2	Time/Date	10-8
10.6.3	Too Long in Phase	10-9
10.6.4	Setup	10-9
10.7	Print Values	10-11
10.7.1	All Values	10-11
10.7.2	All Values Changed	10-12
10.7.3	A Particular Cycle	10-12
10.8	Standby	10-14
10.9	Display Sensors	10-15
10.10	Supervisory	10-16
10.10.1	Change Customer Name	10-18

Table of Contents (continued)

Section	Description	Page
10.10.2	Change Sterilizer ID	10-19
10.10.4	Change Access Codes	10-20
10.10.3	Default Values	10-20
	Change Values Access Codes	10-20
	Sterilizer Operation Access Codes	10-24
	Supervisory Access Code	10-28
10.10.5	Display Access Codes	10-30
10.10.6	RS-232 Interface	10-32
10.10.7	Override Interlocks	10-33
10.11	Service Mode	10-34
11	ROUTINE MAINTENANCE	11-1
11.1	Preventive Maintenance Schedule	11-1
11.2	Clean Chamber Drain Strainer	11-3
11.3	Weekly Maintenance	11-4
11.3.1	Clean Chamber	11-4
11.3.2	Flush Chamber Drain	11-4
11.3.3	Change Printer Paper Roll	11-5
11.3.4	Change Printer Ink Cartridge	11-7
11.4	Replace Door Seal	11-9
12	TROUBLESHOOTING	12-1
12.1	General	12-1
12.1.1	Typical Alarm Screen	12-1
12.1.2	Typical Alarm Printout	12-2
12.2	In-Cycle Alarms	12-2
12.2.1	Too Long In Charge	12-2
12.2.2	Too Long In Exhaust	12-3
12.2.3	Too Long In Evacuation	12-3
12.2.4	Too Long In Air Break	12-4
12.2.5	Under Sterilize Temperature	12-5
12.2.6	Over Sterilize Temperature	12-6
12.2.7	Door Unsealed	12-7
12.2.8	Chamber Pressure/Temperature Failure	12-7
12.3	Out-of-Cycle Alarms	12-9
12.3.1	Too Long To Close Door	12-9
12.3.2	Too Long To Open Door	12-10
12.3.3	Pressure In Chamber	12-10
12.3.4	Waste Temperature Probe Failure	12-11

Table of Contents (continued)

Section	Description	Page
12.4	Sensor Alarms	12-12
12.4.1	Water In Chamber	12-12
12.4.2	Too Long In Jacket Charge	12-12
12.4.3	Too Long To Seal Door	12-13
12.4.4	Too Long To Unseal Door	12-14
12.4.5	Chamber Pressure Transducer Failure	12-14
12.4.6	Chamber Temperature Probe Failure	12-15
12.4.7	Jacket Temperature Probe Failure	12-16
12.4.8	Door Switch Failure	12-16
12.5	Other Alarms	12-17
12.5.1	Input/Output Board Communication Failure	12-17
12.5.2	Exhaust Rate Too Fast	12-18
12.5.3	Exhaust Rate Too Slow	12-18
12.5.4	Atmospheric Pressure Alarm	12-19
12.5.5	Display Error	12-19
12.5.6	Too Long in Sterilize	12-20
12.5.7	Door "A" Seal Failure–Out of Cycle	12-20
12.5.8	Door "B" Seal Failure–Out of Cycle	12-21
13	SERVICE PROCEDURES	13-1
13.1	Air Filter Replacement	13-1
13.2	Clean Strainers	13-1
13.4	Steam Trap Replacement	13-2
13.5	Clean or Replace Valves	13-3
13.6	Recommended Spare Parts	13-6
13.7	Waste Products Disposal	13-6

Life Sciences

LISTING OF WARNINGS AND CAUTIONS



1

The following is a listing of the safety precautions which must be observed when operating this equipment. WARNINGS indicate the potential for danger to personnel, and CAUTIONS indicate the potential for damage to equipment. These precautions are repeated (in whole or in part), where applicable, throughout the manual. Carefully read all safety precautions before using the equipment.

WARNING – ELECTRIC SHOCK AND BURN HAZARD:





-  **Disconnect all utilities to sterilizer before servicing.** Do not service the sterilizer unless all utilities have been properly locked out. Always follow OSHA Lockout-Tagout and electrical safety-related work practice standards. (See 29CFR 1910.147 and .331 through .335.)





WARNING – PERSONAL INJURY HAZARD:

-  **Avoid personal injury from bursting bottles.** Liquid sterilization cycle must only be used for liquids in borosilicate (Pyrex) flasks with vented closures.
-  **When closing the chamber door.** Keep hands and arms out of the door opening and make sure opening is clear of obstructions.
-  **In case of emergency situation,** press the Emergency Stop Button to halt sterilizer and contact a qualified service technician to return sterilizer to normal operation.

Door must be locked and the key retained prior to entering chamber for servicing. Always follow appropriate lockout-tagout and electrical safety related work practice standards. Emergency stop button can be depressed and key retained for this purpose.

WARNING – BURN HAZARD:

-  **It is inappropriate for a healthcare facility to sterilize liquids for direct patient contact.**
-  **When sterilizing liquids,** to prevent personal injury or property damage resulting from bursting bottles and hot fluid, you must observe the following procedures:
 - Use Liquid cycle only; no other cycle is safe for processing liquids.
 - Use only vented closures; do not use screw caps or rubber stoppers with crimped seal.
 - Use only Type I borosilicate glass bottles; do not use ordinary glass bottles or any container not designed for sterilization.
 - Do not allow hot bottles to be jolted; this can cause hot-bottle explosions. Do not move bottles if any boiling or bubbling is present.
-  **Sterilizer, rack/shelves, and loading car will be hot after cycle is run.** Always wear protective gloves and apron when removing a processed load. Protective gloves and apron must be worn when reloading sterilizer following the previous operation.
-  **Do not attempt to open the sterilizer door if a **WATER IN CHAMBER ALARM** condition exists.** Call a qualified service technician before attempting to use sterilizer.
-  **After manual exhaust, steam may remain inside the chamber.** Always wear protective gloves, apron and a face shield when following emergency procedure to unload sterilizer. Stay as far back from the chamber opening as possible when opening the door.

-  **Allow sterilizer to cool to room temperature** before performing any cleaning or maintenance procedures.
-  **Failure to shut off the steam supply** when cleaning or replacing strainers can result in serious injury.
-  **Jacket pressure must be 0 psig (0 bar) before beginning work on the steam trap.**
-  **Proper testing of the safety valve requires the valve to be operated under pressure.** Exhaust from the safety valve is hot and can cause burns. Proper safety attire (gloves, eye protection, insulated overall) as designated by OSHA, is required. Testing is to be performed by qualified service personnel only.



WARNING – EXPLOSION HAZARD:

-  **This sterilizer** is not designed to process flammable compounds.



WARNING – SLIPPING HAZARD:

-  **To prevent falls keep floors dry** by immediately wiping up any spilled liquids or condensation in sterilizer loading or unloading area.















WARNING – PERSONAL INJURY AND/OR EQUIPMENT DAMAGE HAZARD:

-  **Regularly scheduled preventive maintenance is required** for safe and reliable operation of this equipment. Contact your STERIS Service Representative to schedule preventive maintenance.
-  **When closing the chamber door,** keep hands and arms out of the door opening and make sure opening is clear of obstructions.
-  **Repairs and adjustments to this equipment** must be made only by fully qualified service personnel. Maintenance performed by inexperienced, unqualified persons or installation of unauthorized parts could cause personal injury or result in costly equipment damage.







WARNING – STERILITY ASSURANCE HAZARD:

-  **Load sterility may be compromised if the biological indicator or air leak test indicates a potential problem.** If these indicators show a potential problem, refer the situation to a qualified service technician before using the sterilizer.
-  **According to AAMI and EN285 standards, a measured leak rate greater than 1 mm Hg/minute (1.3 mbar/min) indicates a problem with the sterilizer.** Refer the situation to a qualified service technician before using the sterilizer.

CAUTION – POSSIBLE EQUIPMENT DAMAGE:

-  Gasket must be fully retracted prior to operating sterilizer door.
-  If 0 dry time is selected, sterilizer automatically initiates a vapor removal phase in place of drying. This phase can still draw a vacuum to 5 inHg. Consult device manufacturer's recommendations to ensure devices being processed can withstand this depth of vacuum.
-  Never use a wire brush, abrasives or steel wool on door and chamber assembly. Do not use cleaners containing chloride on stainless-steel surfaces. Chloride-based cleaners will deteriorate stainless steel, eventually leading to failure of the vessel.
-  Allow thermostatic traps to cool down to room temperature before removing cover. Since there is nothing to limit expansion, the bellows may rupture or fatigue if trap is opened while hot.
-  Actuation at less than 75% of rated pressure can allow debris to contaminate the seat and cause the safety valve to leak. A leaking safety valve must be replaced.
-  Insufficient service clearance will make repairs more difficult and time consuming.
-  Piping sized too small may cause water hammer, resulting in damage to the sterilizer.
-  After installation, it is mandatory to brace piping at the drain funnel so that it will not move vertically.
-  Make sure door opening is clear of any obstruction before closing the door(s).
-  Do not attempt to open sterilizer door during manual operation unless chamber is at 0 psig (0 bar).
-  During manual operation, gasket must be fully retracted prior to operating sterilizer door.
-  Immediately wipe up saline solution spills on loading car, to prevent damage to stainless steel.
-  Do not use cleaners containing chlorides on loading cars. Chloride-based cleaners will deteriorate the loading car metal.
-  Sterilization of chloride-containing solutions (e.g., saline) can cause chamber corrosion and is not recommended by the manufacturer. If, however, chloride-containing solutions must be processed, clean the chamber after each use.

1.1 Definition of Symbols

Symbol	Definition
	Transfer of Heat, Hot Surface
	Protective Earth (Ground)
	Electrostatic Sensitive Device
	Locked Cycle or Setup Options
	Unlocked Cycle or Setup Options
	Attention, Consult Manual for Further Instructions
A	Amperage Rating of the unit
V	Voltage Rating of the unit
~	Alternating Current
kW	Power Rating of the unit
Hz	Frequency of the unit
ϕ	Phase of the unit
SN	Serial Number of Unit

An Equipment Drawing showing all utility and space requirements was supplied with the sterilizer. Clearance space shown on the drawing is necessary for ease of installation and to assure proper operation and maintenance of equipment. Uncrating and Installation Instructions were also furnished with the sterilizer. If any of these documents are missing or misplaced, contact STERIS giving the serial and model numbers of the equipment. Replacement copies will be sent to you promptly.

After installing this unit according to the instructions provided, complete the following checklist to assure that your installation is complete and correct. Or, if you desire, contact your STERIS representative for a technician to be scheduled to test your installation and demonstrate proper equipment operation.

2.1 Installation Checklist

2.1.1 Service Clearance



CAUTION: Insufficient service clearance will make repairs more difficult and time consuming.

- Clearance as specified on the Equipment Drawing must be available.

2.1.2 Plumbing Services



CAUTION: Piping sized too small may cause water hammer, resulting in damage to the sterilizer.

- Feed Water:**
 - All supply line shutoffs must be provided with lockout capability.
 - Backflow prevention is by others.
 - Water Pressure – measured (specification is 20 to 50 psig [1.4 to 3.5 bar], dynamic). Water pressure supplied must be within specifications as shown on the Equipment Drawing. If pressure is too high, a regulator must be installed. If water pressure is too low, equipment performance will be affected.
 - Water Quality – supplied must be within specifications. Improper water quality adversely affects equipment operation. Damage to the equipment due to improper water quality is not covered under warranty.
- Steam Supply:**
 - Shut-offs (with provisions for lockout and tagout) located nearby.
 - Supply piping adequately sized.
 - Supply pressure measured (specification is 50 to 80 psig [3.5 to 5.2 bar], dynamic).
- Drain Piping** must be sloped properly, and sized to handle the maximum waste flow from the sterilizer.



CAUTION: After installation, it is mandatory to brace piping at the drain funnel so it will not move vertically.

2.1.3 Electrical Service

- Electric single-phase service to the unit must be as specified on the Equipment Drawing and on the Machine Data Plate.
- Electric single-phase service requires a clearly marked disconnect with lockout/tagout capability located near the sterilizer.
- Electric single-phase service should be on a separate circuit, and not tied into circuits containing large reactive loads (e.g., motors).
- The sterilizer's protective ground must be connected to terminal block TB-1 in the sterilizer power box.
- Three-phase power for vacuum pump must meet specifications on the equipment drawing.
- 3-phase service requires a clearly marked disconnect with lockout/tagout capability located near the sterilizer.

2.1.4 Sterilizer Final Check

- Chamber leveled properly.
- Door opens and closes smoothly.
- Door locked switches adjusted correctly.
- Chamber strainer in place.
- Rack and shelves and/or loading car operates correctly.
- Paper loaded in printer.
- Printer ribbon properly installed.
- Warranty labels properly applied.

2.1.5 Cycle Operation

⚠ WARNING-EXPLOSION HAZARD: This sterilizer is not designed to process flammable compounds.

- Unit powers up correctly.
- Run Leak Test cycle — leak rate is to be less than 1.0 mm Hg/minute.
- Verify operation of a typical cycle (270°F [132° C] prevacuum).

2.2 Technical Specifications

2.2.1 Overall Size

Width x Height x Depth

- **26" Sterilizer:** 46^{-3/4} x 78^{-1/2} x 38^{-3/8}"
(1188 x 1994 x 975 mm)
- **39" Sterilizer:** 46^{-3/4} x 78^{-1/2} x 53^{-3/4}"
(1188 x 1994 x 1340 mm)
- **49" Sterilizer:** 46^{-3/4} x 78^{-1/2} x 62^{-3/4}"
(1188 x 1994 x 1594 mm)
- **61" Sterilizer:** 1188 x 1994 x 1899 mm
(46^{-3/4} x 78^{-1/2} x 74^{-3/4}" deep)

- 2.2.2 Weight**
- **26" Sterilizer:** 2400 lbs (1089 kg)
 - **39" Sterilizer:** 2700 lbs (1222 kg)
 - **49" Sterilizer:** 3200 lbs (1450 kg)
 - **61" Sterilizer:** 3500 lbs (1211 kg)

2.2.3 Utility Requirements

- **Electric – USA:**
Controls: 120 VAC, 2A, 1-phase, 60 hz
Vacuum Pump: 208/240 VAC, 6A, 3-phase, 60 hz; or
480 VAC, 3A, 3-phase, 60 hz
- **Electric – International (except UK):**
Controls: 230 VAC, 1.5A, 1-phase, 50 hz
Vacuum Pump: 400 VAC, 4A, 3-phase, 50 hz
- **Electric – UK:**
Controls: 230 VAC, 1.5A, 1-phase, 50 hz
Vacuum Pump: 400 VAC, 6A, 3-phase, 60 hz
- **Water:**
Pressure: 30 to 50 psig (2.07 to 3.5 bar)
Temperature: 70°F (21°C), maximum
Consumption: 15 gpm (57 lpm), peak
- **Steam:**
Pressure: 3.45 to 5.5 bar (50 to 80 psig)
Consumption:
 - **26" Sterilizer** – 150 lb/hr (68 kg/hr), peak
 - **39" Sterilizer** – 148 lb/hr (67 kg/hr), peak
 - **49" Sterilizer** – 148 lb/hr (67 kg/hr), peak
 - **61" Sterilizer** – 148 lb/hr (67 kg/hr), peak

2.2.4 Environmental Conditions

Temperature: 10° to 32°C (50° to 90°F)
Humidity: 10 to 90% noncondensing
Pollution Degree: 2
Installation Category (Overvoltage Category): II
A-Weighted Sound Power Level: ≤ 85 dBA (maximum)

Life
Sciences

The information in this section is intended as a general guide to steam sterilization techniques. For a more detailed description of this subject, refer to the following publication available from STERIS:

- Preparing Instruments, Utensils, and Textiles for Sterilization and Wet Pack Problem Solving (M1844)

STERIS also recommends reference to the standards of Association for the Advancement of Medical Instrumentation (AAMI).

Prior to sterilization, all materials and articles must be thoroughly cleaned.

3.1 General

After sterilization, most goods should be stored for no longer than 30 days, depending on wrapping materials.

For sterilization of articles or materials not covered in this section, contact the manufacturer of the article for recommended procedure. Cycle times and temperatures not covered in this manual should always be validated for efficacy before processing loads.*

** For in-depth training, STERIS offers a wide range of education/training programs designed to meet the educational needs of scientific industries. Contact STERIS for details.*

3.2 Recommended Sterilization Variables

3.2.1 Prevacuum Cycle

Prevacuum cycle is recommended to process heat- and moisture-stable goods, except liquids, which are capable of being sterilized with steam. This cycle can also be used to decontaminate wastes, including wastes containing liquids, provided the materials are properly contained.

Refer to **Table 3-1** for recommended Prevacuum cycle parameters.

Table 3-1. Prevacuum Cycle Parameters

Temperature	Pressure Point psig (psia)	Minimum Recommended Sterilize Time* Minutes at Temperature
121°C (250°F)	12-14 (27-29)	15
132°C (270°F)	26-28 (40-42)	4

** Minimum sterilize times are based on obtaining a 10⁻⁶ Sterility Assurance Level (SAL) with standard test loads. Your specific loads may require different sterilize times to achieve this level of sterility, or you may require a different SAL.*

3.2.2 Gravity Cycle

Refer to **Table 3-2** for the type of items which can be processed in a Gravity cycle and the recommended cycle parameters.

Table 3-2. Gravity Cycle Parameters

Items	Minimum Recommended Sterilize Time at 121°C (250°F)	Minimum Recommended Sterilize Time at 132°C (270°F)	Dry Time
Glassware, empty, inverted, without closures*	15 minutes	3 minutes	0 minutes**
Instruments, metal combined with suture, tubing or other porous materials (unwrapped)	20 minutes	10 minutes	0 minutes**
Hard Goods, unwrapped	15 minutes	3 minutes	0 minutes**
Hard Goods, wrapped in muslin or equivalent	30 minutes	15 minutes	30 minutes***

* If items which can trap air must be sterilized upright, they should be sterilized in a prevacuum cycle.

** Goods will be wet when removed from sterilizer.

*** Dry time can vary for wrapped goods depending on pack density, weight of goods, pack preparation technique including type of wrapping material used, and sterilizer loading procedures.

3.2.3 Liquid Cycle

Refer to **Table 3-3** for recommended Liquid cycle parameters. The recommended times indicated in **Table 3-3** assume the use of vented bottles or Erlenmeyer flasks. The "minimum sterilization time" includes the time required to bring the solution up to the sterilize temperature plus the time required to achieve sterilization.

NOTE: Load probes and F_0 option will allow you to optimize cycle times.

Table 3-3. Liquid Cycle Parameters - No Load Probes

Volume of Liquid in One Container	Minimum Recommended Sterilize Time* at 121°C (250°F) minutes
75 mL	25
250 mL	30
500 mL	40
1000 mL	45
1500 mL	50
2000 mL	55
> 2000 mL	55 + 10 min/L

* Minimum sterilize times are based on obtaining a 10^6 Sterility Assurance Level (SAL) with standard test loads. Your specific loads may require different sterilize times to achieve this level of sterility, or you may require a different SAL.

⚠ WARNING – EXPLOSION HAZARD: This sterilizer is not designed to process flammable liquids.

⚠ WARNING – BURN HAZARD: When sterilizing liquids, you must observe the following procedures:

- It is inappropriate for a health care facility to sterilize liquids for direct patient contact.
- Use Liquid cycle only.
- Use only vented closures.
- Use only Type I borosilicate glass bottles.
- Do not allow hot bottles to be jolted.

3.3 Recommendations for Sterilizing Liquids

WARNING – EXPLOSION HAZARD: This sterilizer is not designed to process flammable compounds.

WARNING – BURN HAZARD: When sterilizing liquids, you must observe the following procedures:

- It is inappropriate for a health care facility to sterilize liquids for direct patient contact.
- Use Liquid cycle only.
- Use only vented closures.
- Use only Type I borosilicate glass bottles.
- Do not allow hot bottles to be jolted.

CAUTION: Sterilization of chloride-containing solutions (e.g., saline) can cause chamber corrosion and is not recommended by the manufacturer. If, however, chloride-containing solutions must be processed, clean the chamber after each use.

IMPORTANT: Please read the following paragraphs before sterilizing any liquids in your sterilizer. It is inappropriate for a health care facility to sterilize liquids for direct patient contact.

Borosilicate glass is required because it is a superior glass capable of resisting thermal shock. If glass not as thermally resistant is used, a greater potential for bursting exists.

Vented closures are required because, by design, they release internal pressure build-up by automatically venting the containers, whereas pressure in unvented containers remains until the contents have cooled. Examples of vented closures are shown in Figure 3-1.

Sterilizing liquids in any other type of container or with the use of non-vented closures requires a sterilizer specifically designed for that purpose.

When loading, place small bottles in a separate basket to minimize sliding. Always use side rails on the loading car to prevent containers or baskets from falling off.

For extremely large liquid loads, a DART warm-up cycle may be required.

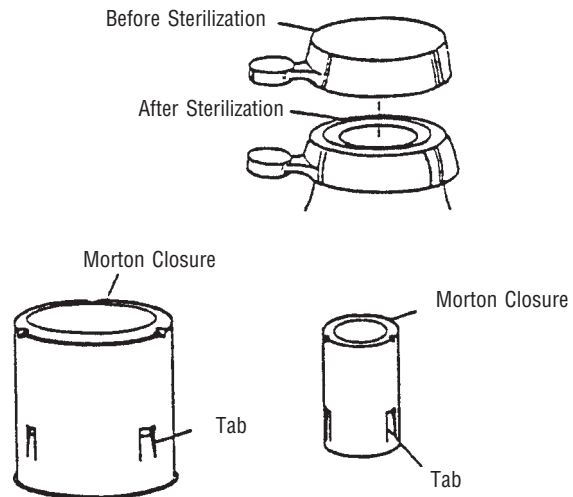

Figure 3-1. Vented Closures

3.4 Recommendations for Enhancing the Sterilization Process

Saturated steam is a well controlled, reliable method for processing items which can withstand the temperatures and pressures associated with steam sterilization. The requirements for achieving reproducible results are well known by many users, but are not always understood by all users.

The condition most likely to result in sterilization problems is a failure to remove all of the air from the items being processed. For example, placing an empty beaker or bowl in an upright position in a gravity displacement sterilizer may result in the object not being sterilized, or may require exceptionally long sterilization times. This problem is due to the fact air has almost twice the density as does saturated steam under the same conditions. Thus, the air sits in the bottom of the container, and the steam forms a stable layer over the air. This effect is similar to oil forming a stable layer over water. As long as there is no mechanism for actively mixing the two, the bottom of the container will only see dry heat, which is not an effective sterilization method at the temperatures typically used in steam processes.

There are two methods for enhancing the sterilization of solid bottom containers in gravity displacement cycles. These are:

- Place 1 to 2 mL of water in the bottom of each container. The expansion of the water into steam as the product is heated will force most of the air out of the object, thus allowing steam to reach all surfaces and effect sterilization.
- The better, more reliable method is to orient all objects in a manner which would allow water to flow out. When the steam enters the chamber, it will tend to layer over the air. However, the object is now oriented so the air can flow out. As the air flows out of the container, it will be replaced by the steam. The steam can now reach all surfaces and effect sterilization.

The best type of cycle for assuring sterilization of containers, and of objects which contain lumens or tortuous paths, is the prevacuum cycle. In this process, several vacuum pulses remove all of the air from the load. The steam can then immediately contact all surfaces. This immediate contact results in dramatically shorter sterilization times than are required when complete air removal cannot be assured. Items which take 15 to 30 minutes to sterilize in a gravity displacement cycle can be sterilized in 4 minutes or less at 132°C (270°F).

Objects which do not allow easy passage of steam or air cannot be effectively sterilized with any steam process. For example, pipette cans with lids in place do not allow all the air to flow out, or the steam to flow in, even with prevacuum cycles. In a gravity cycle, these items have a high probability of being non-sterile. In a prevacuum cycle, these items may be crushed by the steam pressure because the chamber pressure changes much faster than does the pressure inside the canister.

Items which are hermetically sealed (e.g., empty screw cap bottles) cannot be sterilized by any steam process because the steam cannot get into the device, and air cannot get out. If you must process these items, make certain the screw caps are loosened at least one half turn (more would be better). Verify your process is capable of sterilizing these objects by running biological indicators in the bottom of the bottle. If the biological indicators are not killed, the caps need to be loosened even further, or the bottles need to be sterilized separately from the caps (cover the bottles with Kraft paper, peel pouches or some other steam permeable material).

3.5 Control Measures For Verifying Sterilization Process

3.5.1 Biological Monitors

As part of the operator's verification of the sterilization process, biological indicators may be used to demonstrate that sterilization conditions have been met.

NOTE: Contact your STERIS representative for information on specific biological indicators recommended for use with this sterilizer.

A live spore test utilizing *B. stearothermophilus* is the most reliable form of biological monitoring. This type of product utilizes controlled populations of a controlled resistance, so that survival time and kill time can be demonstrated.

To verify the process, insert the biological indicator in a test pack and place pack on the bottom shelf. Run test pack through a typical cycle. On completion, forward test pack and monitor to appropriate personnel for evaluation. Refer to AAMI guidelines to conduct routine biological monitoring.

3.5.2 Testing for Prevacuum Efficiency

⚠ WARNING – STERILITY ASSURANCE HAZARD: Load sterility may be compromised if the biological indicator or air leak test indicates a potential problem. If these indicators show a potential problem, refer the situation to a qualified service technician before using the sterilizer.

Run a DART (Bowie-Dick test) cycle daily before processing any loads. The first prevacuum cycle of each day should be used to test the adequacy of air removal from the chamber and load, so that steam can penetrate the load. It is not a test for adequate exposure to heat in terms of time-at-temperature.

Tests such as the Bowie-Dick or the DART® (Daily Air Removal Test)* are designed to document the removal of residual air from a sample challenge load.

In the case of these tests, following exposure in a prevacuum sterilizing cycle, the pack is opened, the indicator examined and conclusions are drawn as to the pattern of residual air, if any, that remained in the pack during the sterilizing cycle. Any indication of a malfunction must be reported to the supervisor, who will take appropriate action to determine the cause of the problem. Sterilizer should not be used during this time.

* Call STERIS to obtain.

3.6 Dart (Bowie-Dick) Test

Conduct a residual air test (e.g., Bowie-Dick test) at the beginning of each day according to the AAMI standard ST-46. STERIS can provide a product called DART® (Daily Air Removal Test), designed to be as sensitive as the standard AAMI Bowie-Dick test pack in detecting air leaks. Refer to instructions for running DART test given in *SECTION 6* of this manual. If a DART is not available, construct Bowie-Dick test package in accordance with instructions given in AAMI standard ST-8.

3.7 Vacuum Leak Test

Run the Vacuum Leak test cycle daily or weekly. This test measures the integrity of the sealed pressure vessel and associated piping to assure air is not being admitted to the sterilizer during the vacuum draw downs. Refer to appropriate cycle description in *SECTION 6* of this manual.



WARNING – STERILITY ASSURANCE HAZARD: According to AAMI standards, a measured leak rate greater than 1 mm Hg/minute indicates a problem with the sterilizer. Refer the situation to a qualified service technician before using the sterilizer.

After running a vacuum leak test, a value or leak rate will be printed on the printer tape. This value will help define a trend over a period of time if the integrity of the system begins to deteriorate (i.e., allowing air to enter the system). By running a vacuum leak test cycle daily or weekly, the operator or maintenance personnel can always monitor the air tightness of the system and make repairs or adjustments when necessary.

NOTE: A leak rate of greater than 1 mmHg per minute indicates a problem with the sterilizer that must be addressed.

COMPONENT IDENTIFICATION

Amsco Century Sliding-door Prevacuum Steam Sterilizers are steam-jacketed sterilizers designed to process a variety of loads using saturated steam under pressure and mechanical or gravity air removal principles.

The sterilizer is equipped with a fully-programmable microcomputer control system capable of storing process cycles for sterilizing hard goods, lightly wrapped porous loads and liquid loads in vented containers. The control system monitors and automatically controls all cycle operations and functions.

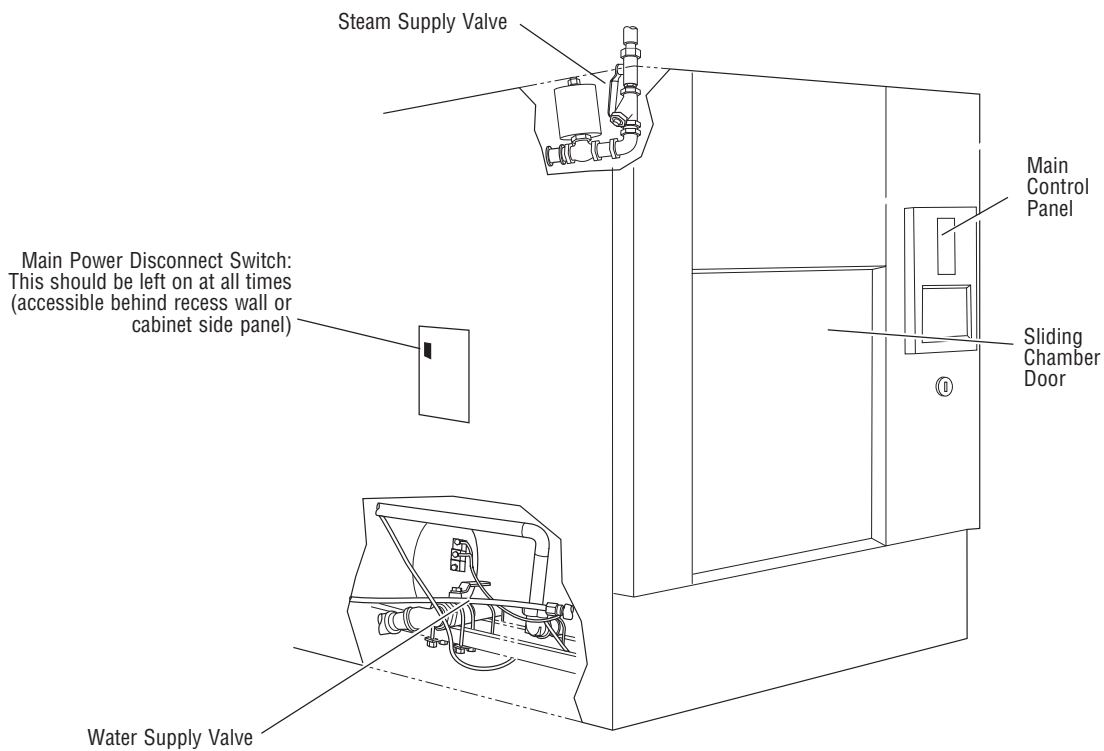
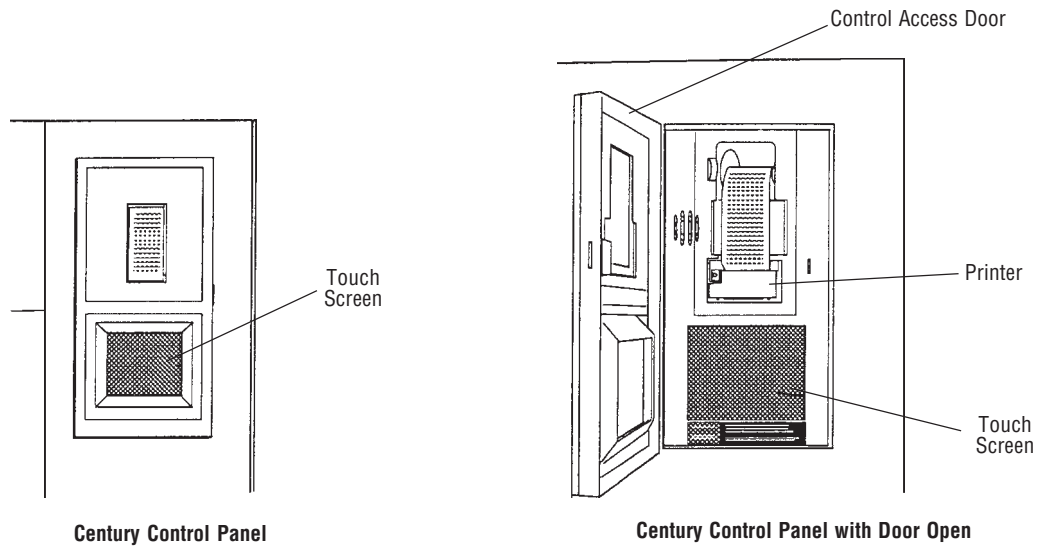

Figure 4-1. Century Sliding Door Prevacuum Steam Sterilizer

4.1 Main Power Disconnect Switch

- **Main Power Disconnect Switch** (refer to Figure 4-1) – Located at the side of the sterilizer on the main control box, this switch disconnects power to the control. Under normal operation, this switch is left in the ON position at all times, and accessed only when servicing the sterilizer.

4.2 Supply Valves

- **Steam Supply Valve** – This is located behind the side access panel (or within the wall enclosure), above the chamber. Refer to Figure 4-2. Ensure this is in the open position before trying to operate the sterilizer.
- **Water Supply Valve** – This is located behind the side access panel (or within the wall enclosure), below the chamber. Refer to Figure 4-2. Ensure this is in the open position before trying to operate the sterilizer.
- **Chamber Emergency Manual Exhaust Valve** – Used only in emergency situations, the valve is to be left in the closed position for normal operation.

IMPORTANT: Both supply valves to the sterilizer should remain in the ON position at all times for normal unit operation.

4.3 Front Panel Controls, Display and Gauges

- **Sterilizer Control Touch Pad** – This is visible on the control touch screen whenever the sterilizer is in Standby mode. Refer to Figure 4-3.

NOTE: Screen touch pads respond to very slight pressure, and only need to be pressed lightly.

The sterilizer enters operating mode when the ON touch pad is pressed. This touch pad switches the sterilizer control between Standby and Ready conditions (Standby mode is usually used at night when the sterilizer is not being operated—steam is turned off and machine cools, saving energy).

A screen reference number appears in the upper right corner of each display. Numbers are used for reference only, and do not relate to the operating sequence of the screen.

- **Jacket Pressure Gauge** – located on the front panel. Analog gauge registers steam pressure in the sterilizer jacket.
- **Chamber Pressure Gauge** – located on the front panel. Analog gauge registers steam pressure in the sterilizer chamber.
- **Emergency Stop Switch and Key** – located on the front panel, below the sterilizer control touch pad. Shuts off all outputs on the sterilizer; the key is used to reset the switch following actuation. This key is to be retained by the supervisor.

4.4 Emergency Stop Button

4.5 Control Panel

The Control Panel, located on load end of the sterilizer, is used to direct all sterilizer functions (see Figure 4-2). The operator may control cycle operation, program cycles and sterilizer operating parameters and monitor cycle performance from the control panel.

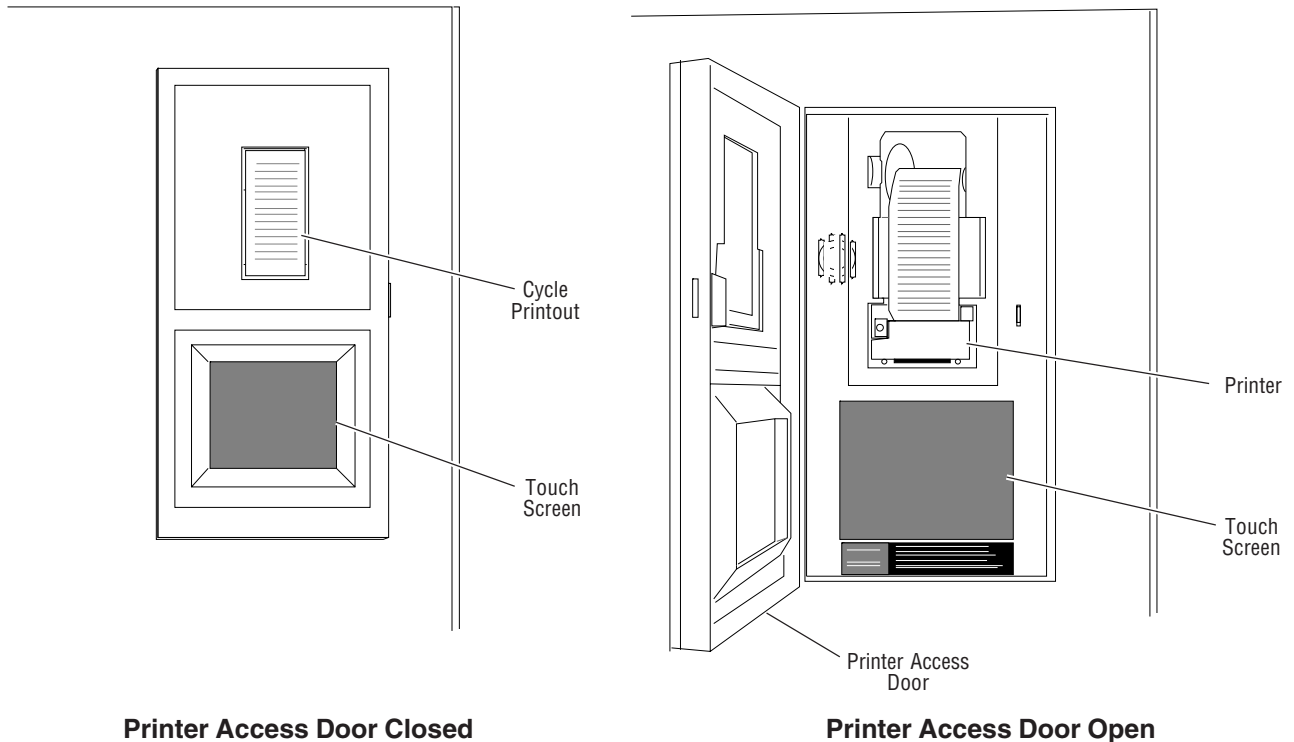

Figure 4-2. Control Panel

4.5.1 Touch Screen

The touch screen allows the user to operate and program the sterilizer control by touching (pressing) the appropriate touch-sensitive areas on the display. On each screen, all rectangular-outlined boxes are touch-sensitive areas, referred to as "buttons" (see Figure 4-3).

Refer to *SECTION 5, CONTROL INTERFACE*, for further details on interfacing with the control system's touch screen.

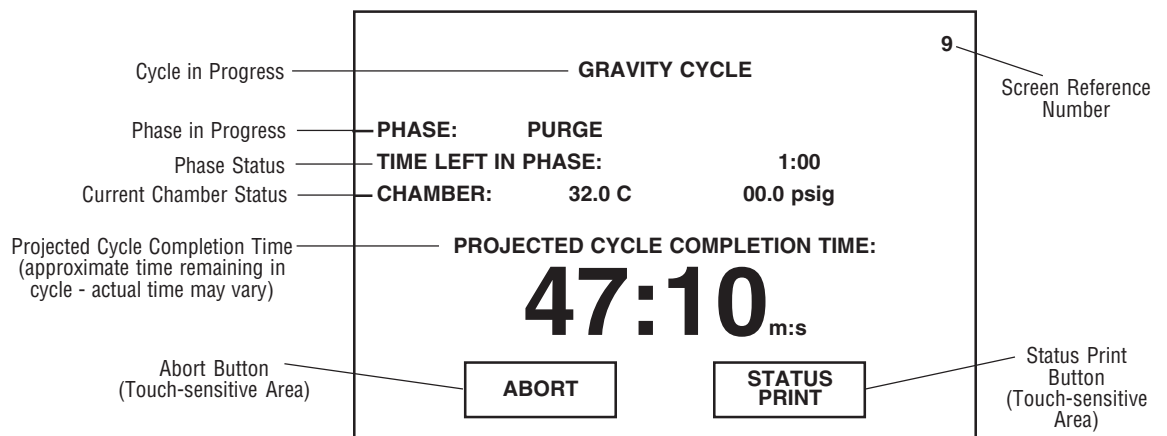

Figure 4-3. Example of In-cycle Touch Screen

4.5.2 Printer

Ink-on-paper printer records all cycle data on 2-1/4 inch wide paper. The generated printout is visible when the printer access door is closed (see Figure 4-4).

All printer functions are controlled using the touch screen. For details on each of the printer functions, refer to *SECTION 5, CONTROL INTERFACE*.

The following is an example of a typical in-cycle printout in the **full print format** (see Figure 4-4).

NOTE: *Extended print format is available; refer to SECTION 9.4.5, PRINT FORMAT.*

- **Operating Mode**

When sterilizer is placed in the Operating mode, the generated printout lists the sterilizer type and manufacturer.

- **Cycle Start**

When a cycle is started, the generated printout lists name of cycle started, time and date the cycle was started, the current cycle count (number of cycles run since original start up of unit), the operator's name, the sterilizer ID number, the default cycle number and type, and the programmed parameters for the cycle started.

NOTE: *Cycle count value may be changed in Service mode.*

- **In-Cycle Performance**

During a cycle, the generated printout lists the current time, chamber pressure and chamber temperature at each transition point.

- **End-of-Cycle Performance Summary**

At the end of a cycle, the generated printout lists number of cycles run that day, the maximum and minimum chamber temperatures reached during the sterilize phase, processing times for key phases and the total cycle time.

- **Alarm Condition**

When an alarm condition occurs, the generated printout (see Figure 4-5) lists the type of alarm and time, chamber temperature and chamber pressure when it occurred.

NOTE: *Refer to SECTION 12, TROUBLESHOOTING, for listing of possible alarm conditions.*

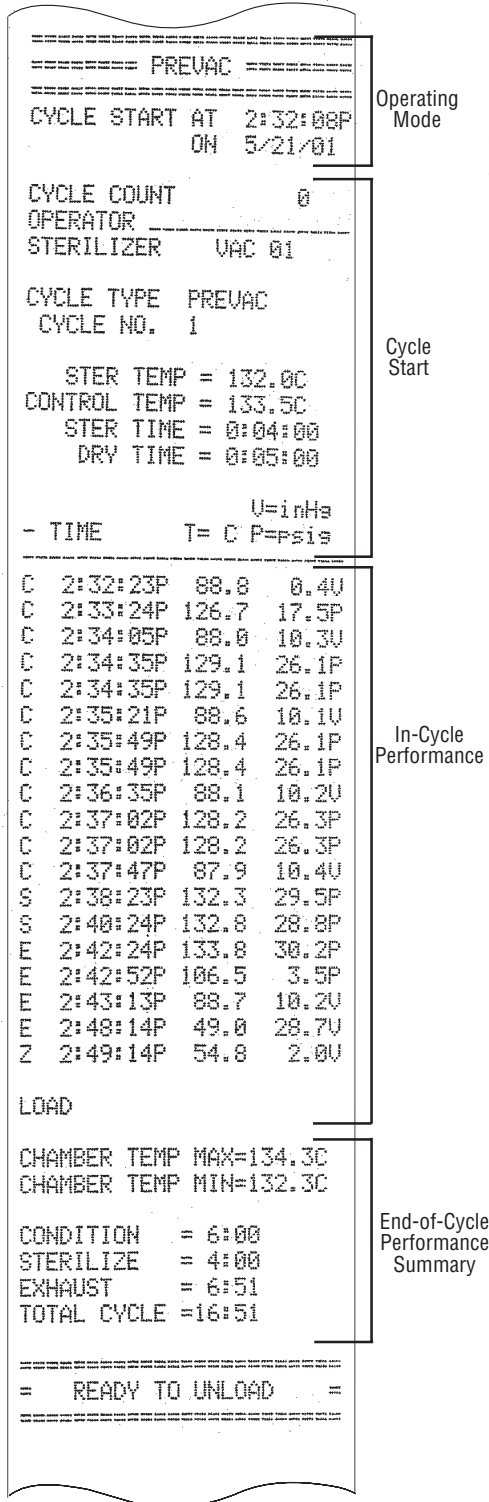

Full Print Format Shown

Figure 4-4. Sample In-cycle Printout

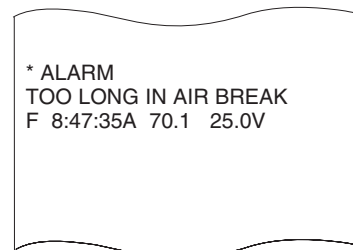

Full Print Format Shown

Figure 4-5. Sample Alarm Printout

4.6 Unload End Control Panel (Double Door Units)

On sterilizers equipped with double doors, an additional control panel is also provided on the sterilizer's unload end. The unload end control panel features a touch screen similar to the one at the load end of the sterilizer (see Figure 4-6). Cycle operation can be started, monitored and aborted using this touch screen. The touch screen display concurrently shows the same screen as the display at the load end of the sterilizer.

NOTE: If sterilizer is equipped with optional dual control capability, cycle value changes and other program adjustments can also be made from the unload end control panel.

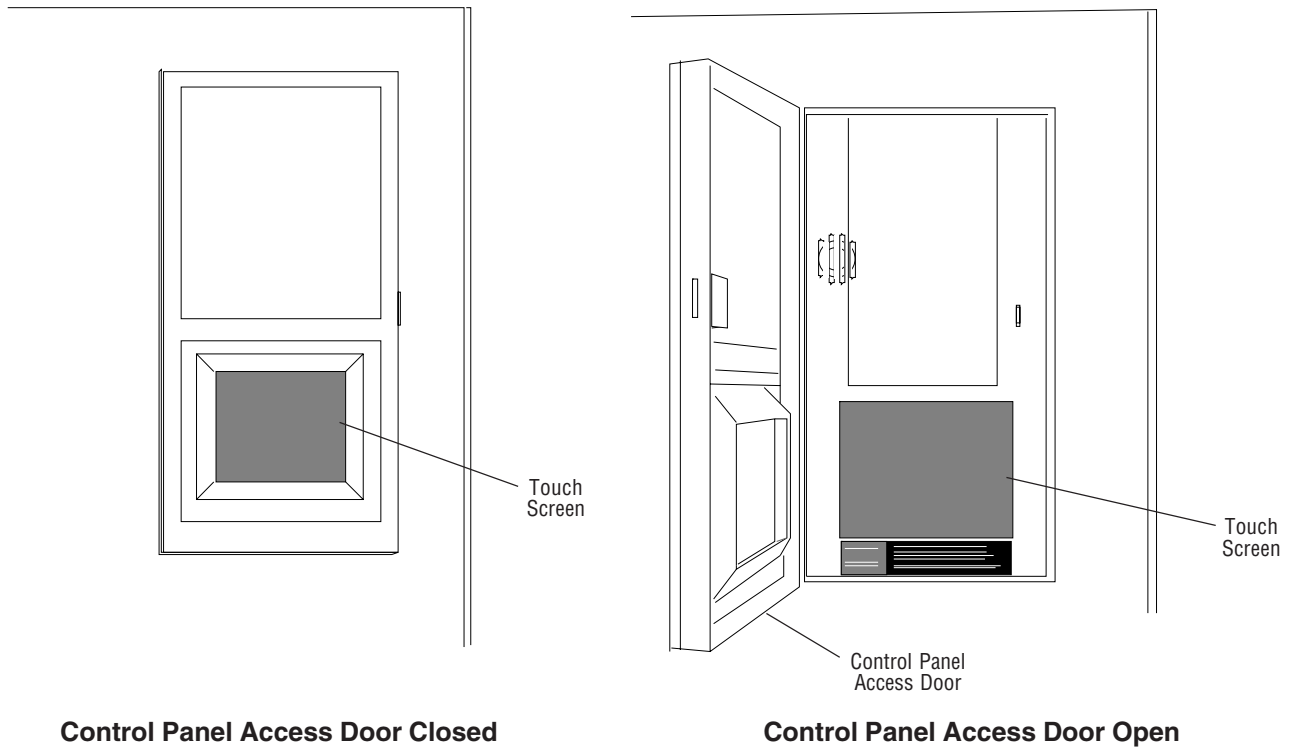

Figure 4-6. Unload End Control Panel

4.7 Power Door Operation

The sterilizer door is operated at the touch screen. (Refer to Figure 4-7.)

- Pressing the “OPEN DOOR” touch screen button while the door is in the closed (up) position causes the door to open (by lowering); it requires 18 seconds to retract the gasket before the door will open (lower).
- Pressing and holding the “CLOSE DOOR” touch screen button while the door is in the open (lowered) position, causes the door to close (by raising). Touch screen button contact must be held until the door closes and the display shows “DOOR CLOSED”.

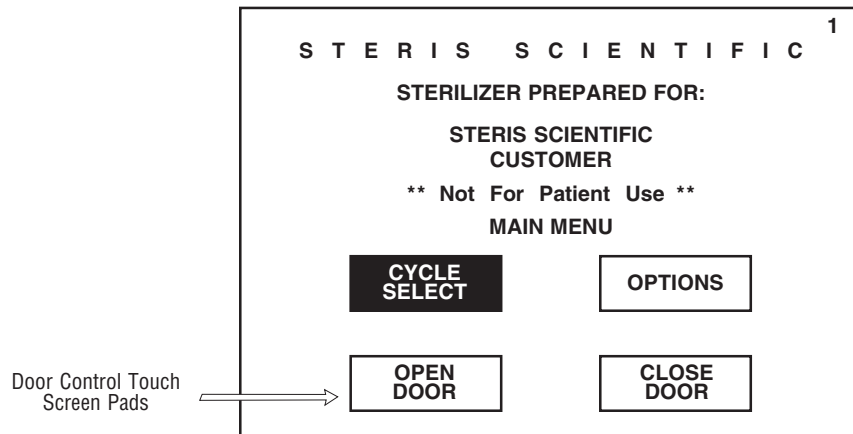

Figure 4-7. Touch Screen

On double door units there is no control of the power door at the opposite end of the unit. Each door of a double door sterilizer is operated from the end at which the door is located.

Important: Keep the door closed when the unit is not in use.

5.1 General

Touch screens allow the user to operate and program the sterilizer by lightly touching (pressing) the appropriate touch-sensitive areas on the display. On each screen, all rectangular-outlined boxes are touch sensitive areas, referred to as “buttons”. When a button is pressed, the display area within the button lights up and an audible tone sounds.

NOTE: Volume of audible tone may be adjusted or turned off. Refer to SECTION 9, PROGRAMMING OPERATING PARAMETERS, for instructions.

Each screen is identified by a number, located in the top right hand corner of the display screen. Numbers are used for reference only and do not relate to the operating sequence of the screens.

Screen #0 is the standby screen; the screen displayed when main power disconnect switch is first positioned to on and when sterilizer is in Standby mode. The **HEXAWAVE** is the touch-sensitive area on this screen. Screen can be customized to include customer name and sterilizer identification number. Refer to SECTION 10, OUT OF CYCLE OPTIONS, for information on changing customer name and sterilizer ID.

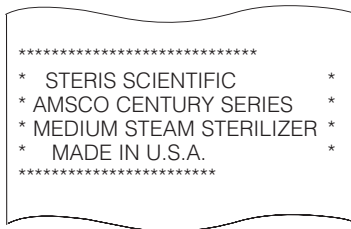
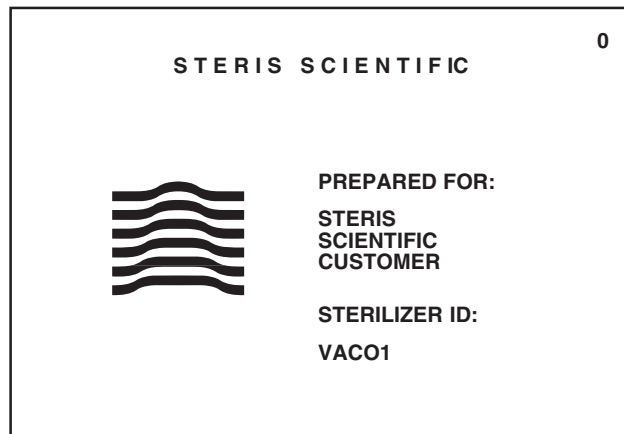

Pressing the **HEXAWAVE** puts sterilizer in the Operating mode, advances display to screen #1 and generates a printed record of the sterilizer type (see Figure 5-1).

Figure 5-1. Sample Printout

Screen #1 is the main menu screen. Customer name also appears on this screen.

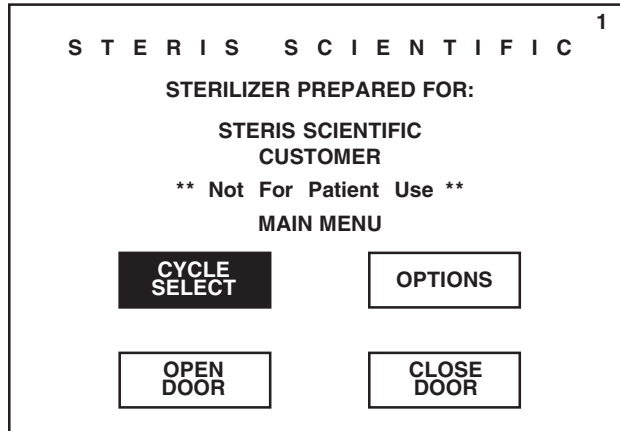

Pressing **CYCLE SELECT** advances display to the first of two Cycle Select menus (screen #2). Refer to SECTION 5.2, CYCLE SELECT MENUS.

Pressing **OPTIONS** advances display to the first of two Out of Cycle Options menus (screen #13). Refer to SECTION 5.3, OUT OF CYCLE OPTIONS MENUS.

If sterilizer is equipped with double doors, screen #1 is replaced by screen #63. Screen #63 includes a SEAL DOOR button in addition to the CYCLE SELECT and OPTIONS buttons. Pressing **SEAL DOOR** seals the load end or unload end door as programmed. Door can only be sealed from the touch screen located on the same end. Refer to SECTION 8, PROGRAMMING CYCLE VALUES, for instructions on programming the interlock feature.

NOTE: If door is currently sealed, the touch screen button will read UNSEAL DOOR. Pressing this button will unseal door as programmed.

5.2 Cycle Select Menus

All processing and test cycles must be selected and started using the Cycle Select menu screens (#2 and #3).

5.2.1 Processing Cycles

After pressing CYCLE SELECT on screen #1, screen #2 appears showing six preprogrammed processing cycles.

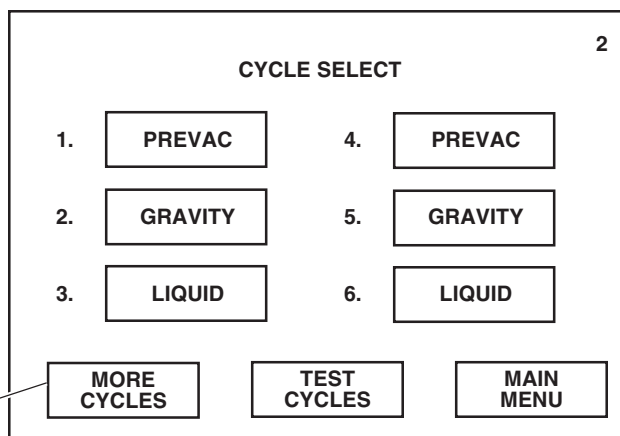

Pressing **MORE CYCLES** displays Cycles 7 through 12 on screen #2.

Pressing **TEST CYCLES** advances display to screen #3.

Pressing **MAIN MENU** returns display to screen #1.

Units with Eighteen Cycle Capability Only

Pressing a **cycle button** advances display to a screen listing the corresponding cycle parameters.

For example: If PREVAC button on screen #2 is pressed, the cycle parameters screen #4 appears. Screen lists the cycle parameters programmed for the selected prevac cycle. Similar cycle parameters screens appear after pressing GRAVITY button and LIQUID button.

NOTE: Processing cycle parameters can be changed by the operator/supervisor. Refer to SECTION 8, PROGRAMMING CYCLE VALUES.

Pressing PREVIOUS returns display to screen #2.

Cycle Name
(Cycle Type)

4	
CYCLE PARAMETERS	
1. PREVAC (PREVAC)	

PURGE TIME	1:00
PULSES	4
MAX: 26.0 psig	MIN: 10.0 inHg
STERILIZE:	
TEMP	132.0 C
TIME	0:04:00
VACUUM DRY	10.0 inHg
DRY TIME	0:05:00
<input type="button" value="PREVIOUS"/> <input type="button" value="START CYCLE"/>	

Pressing **START CYCLE** initiates the selected cycle and advances display to the first in-cycle status screen (#9). Refer to SECTION 6, STERILIZER OPERATION, before running a processing cycle.

5.2.2 Test Cycles After pressing CYCLE SELECT on screen #1, screen #2 appears.

Pressing MAIN MENU returns display to screen #1.

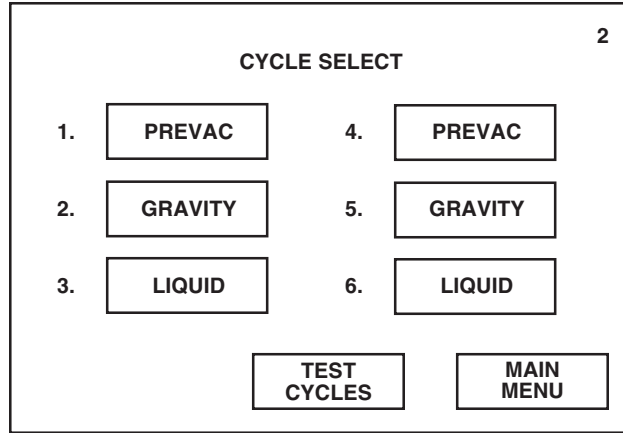

Pressing **TEST CYCLES** advances display to screen #3, the second Cycle Select menu. This screen shows three preprogrammed test cycles.

NOTE: Test cycle parameters are fixed and cannot be changed by the operator/supervisor.

Pressing STANDARD CYCLES returns display to screen #2.

Pressing MAIN MENU returns display to screen #1.

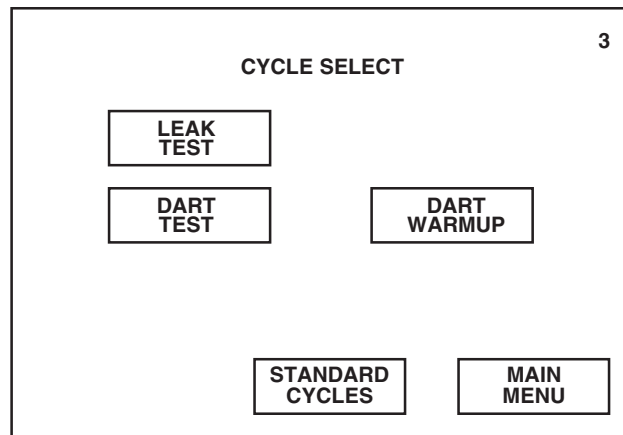

Pressing a **test cycle button** initiates the selected cycle and advances display to the first in-cycle status screen (#9). Refer to SECTION 6, STERILIZER OPERATION, before running a test cycle.

5.3 Out of Cycle Options Menus

All other sterilizer functions, including cycle programming and printer operation, are accessed through the Out of Cycle Options menu screens (#13 and #87). *SECTION 10, OUT OF CYCLE OPTIONS*, describes each function accessible from these menu screens.

After pressing **OPTIONS** on screen #1, screen #13 appears showing six out-of-cycle functions.

*Pressing **NEXT** advances display to screen #87.*

*Pressing **MAIN MENU** returns display to screen #1.*

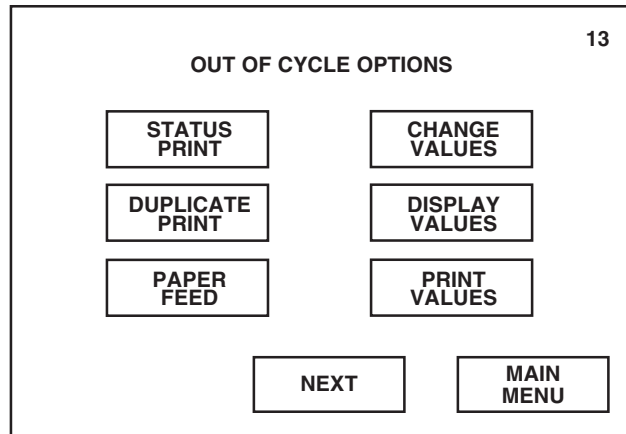

- Pressing **STATUS PRINT** generates a printout listing the time of day and current readings from the pressure and temperature probes. Refer to Section 9 for more information.
- Pressing **DUPLICATE PRINT** generates a printout of cycle data from the last completed cycle. Refer to *SECTION 10.3* for more information.
- Pressing and holding **PAPER FEED** continually advances the printer paper. Refer to *SECTION 10.4* for more information.
- Pressing **CHANGE VALUES** provides access to the Change Values menu. User may program the cycle values and sterilizer operating parameters from the Change Values menu. Refer to *SECTION 8, PROGRAMMING CYCLE VALUES*, and *SECTION 9, PROGRAMMING OPERATING PARAMETERS*, for further information.
- Pressing **DISPLAY VALUES** allows user to view the current programmed cycle values and operating parameters. Refer to *SECTION 10.6* for more information.
- Pressing **PRINT VALUES** allows user to generate a printout of the current programmed cycle values and operating parameters. Refer to *SECTION 10.7* for more information.

After pressing NEXT on screen #13, screen #87 appears showing the remaining out-of-cycle functions.

Pressing PREVIOUS returns display to screen #13.

Pressing MAIN MENU returns display to screen #1.

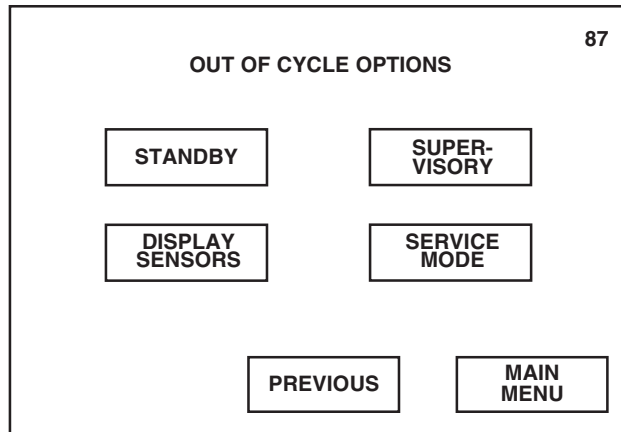

- Pressing **STANDBY** places sterilizer in the Standby mode and returns display to screen #0. Refer to *SECTION 10.8* for more information.
- Pressing **DISPLAY SENSORS** allows user to view the current temperature and pressure readings. Refer to *SECTION 10.9* for more information.
- Pressing **SUPERVISORY** provides access to the Supervisory mode. Refer to *SECTION 10.10* for more information.
- Pressing **SERVICE MODE** provides access to the Service mode. Refer to *SECTION 10.11* for more information.

6.1 Before Operating Sterilizer

⚠ WARNING – SLIPPING HAZARD: To prevent falls, keep floors dry by immediately wiping up any spilled liquids or condensation in sterilizer loading and unloading areas.

The following steps must be performed prior to daily sterilizer usage.

1. Open chamber door and check that drain strainer is clean and in place.
2. Check that chamber interior is clean and close chamber door. Refer to *SECTION 11, ROUTINE MAINTENANCE*, if cleaning is necessary.
3. Open front cabinet panel on load end of the sterilizer. Verify that steam and water supply valves to the sterilizer are on (see Figure 6-1). Close cabinet panel.
4. Open printer access door. Check that sufficient amount of printer paper is available. A colored warning stripe is visible when paper roll is near the end. Refer to *SECTION 11, ROUTINE MAINTENANCE*, if the paper roll needs replaced.

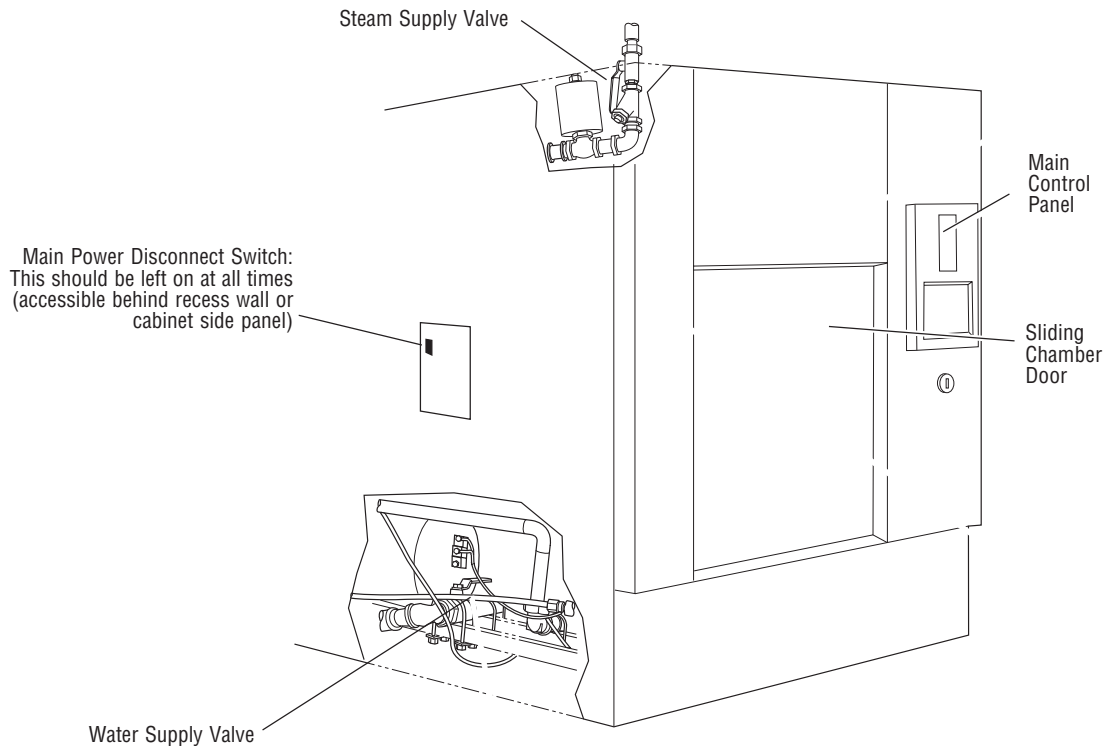
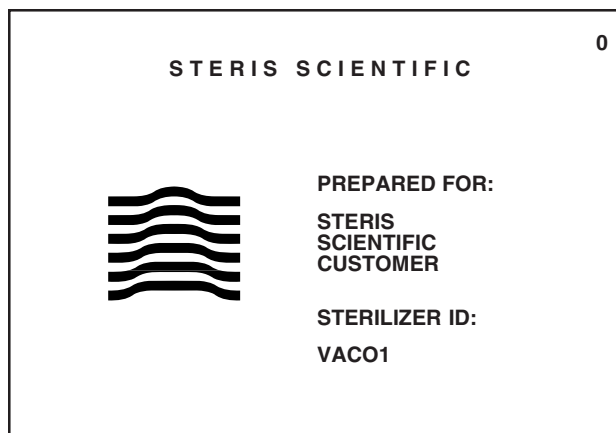

Figure 6-1. Control and Valve Locations

6. Close printer access door and press the **HEXAWAVE** on screen #0. Steam enters the sterilizer jacket and heats jacket to 115°C (239°F). Printer records sterilizer type.



NOTE: If access code feature is activated, an assigned four-digit code must be correctly entered before operator can use the sterilizer. Refer to Section 6, Entering Access Code.

7. Run a Leak Test cycle. Leak Test must be run at least once each week. Refer to SECTION 6.6, *LEAK TEST CYCLE OPERATION*, for instructions on running this cycle.
8. Run a DART Warm-up and a DART Test cycle. DART Test must be run at least once a day. Refer to SECTION 6.7, *DART WARM-UP CYCLE OPERATION* and SECTION 6.8, *DART TEST CYCLE OPERATION*, for instructions on running these cycles.
9. After running the necessary test cycles, load sterilizer chamber as outlined in SECTION 6.2, *UNLOADING THE STERILIZER*, next in this section.

6.2 Unloading the Sterilizer

WARNING – BURN HAZARD: Sterilizer and shelves will be hot after cycle is run. Always wear protective gloves and apron when removing a processed load.

WARNING – BURN HAZARD: Steam may be released from the chamber when door is opened. Step back from the sterilizer each time the door is opened to minimize contact with steam vapor.

WARNING – SLIPPING HAZARD: To prevent falls, keep floors dry by immediately wiping up any spilled liquids or condensation in sterilizer loading or unloading area.

6.2.2 Loading Car Instructions: Loading

At the end of a cycle, when end-of-cycle tone sounds and display shows:

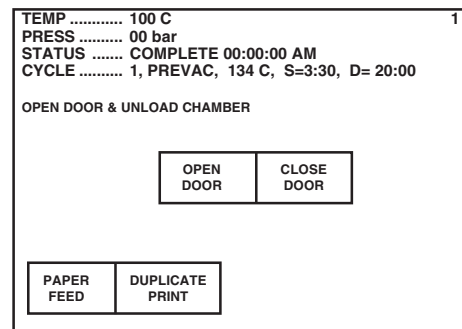

... open the chamber door.

NOTE: Wear clean gloves and use clean towels as “pot holders” when carefully removing load/tray(s) from the sterilizer shelves or loading car.

NOTE: Never place a sterilized tray on a solid shelf or cold surface. Once the tray has cooled, it can be placed on a wire shelf.

1. Remove the load from chamber shelf (shelves). Avoid unnecessary handling.
2. Visually check outside wrapper for dryness. If there are water droplets or visible moisture on the exterior of the package, or on the tape used to secure it, the pack or instrument tray is considered **unacceptable**.
3. To prevent condensation, transfer the load to a surface which is well-padded with fabric. **Do not place load on a cold surface.** Be sure that no air conditioning or cold air vents are in close proximity.
4. Remove packs or instrument trays from the padded surface when they have reached ambient (room) temperature. Depending on the items and environment of the area, this may take a minimum of 1 hour.

IMPORTANT: After removing load(s) from the chamber, close the chamber door and keep the chamber door closed to minimize utility consumption.

1. Open sterilizer door.
2. Verify that loading car is securely fastened to the transfer carriage.
3. Align the front end of the transfer carriage with the end of the sterilizer. (See Figure 5-2).
4. Move carriage forward until latches engage with mating holes in chamber end frame.
5. Verify that transfer carriage is securely latched by pulling transfer carriage backward (transfer carriage should remain stationary).
6. Once transfer carriage is securely latched, release the loading car from the transfer carriage by lifting the carriage lock.
7. Carefully push the loading car off the transfer carriage and fully into the sterilizer chamber.
8. Disengage transfer carriage latches from end frame by pushing carriage latch knob.

9. Back the transfer carriage away from the sterilizer.
10. Close the chamber door.
11. The sterilizer is now ready to run a cycle. Proceed to appropriate cycle description found in *SECTION 6* of this manual.

6.2.2 Loading Car Instructions: Unloading

WARNING – BURN HAZARD: Sterilizer, rack/shelves, and loading car will be hot after cycle is run. Always wear protective gloves and apron when removing a processed load. Protective gloves and apron must be worn when reloading sterilizer following the previous operation.

WARNING – BURN HAZARD: Steam may be released from the chamber when door is opened. Step back from the sterilizer each time the door is opened to minimize contact with steam vapor.

WARNING – SLIPPING HAZARD: To prevent falls, keep floors dry by immediately wiping up any spilled liquids or condensation in sterilizer loading or unloading area.

WARNING – PERSONAL INJURY HAZARD: When closing the chamber door, keep hands and arms out of the door opening and make

1. Open chamber door.
2. Move transfer carriage forward until latches engage with track inside chamber.
3. Verify that transfer carriage is latched to chamber end ring by pulling transfer carriage backward (transfer carriage should remain stationary).
4. Once transfer carriage is securely latched, grasp the loading car handle and carefully pull loading car from chamber onto transfer carriage until transfer carriage latch engages to loading car.
5. Disengage transfer carriage latches from track inside chamber by pushing carriage latch knob.
6. Close the chamber door.
7. Transfer load from sterilizer area.

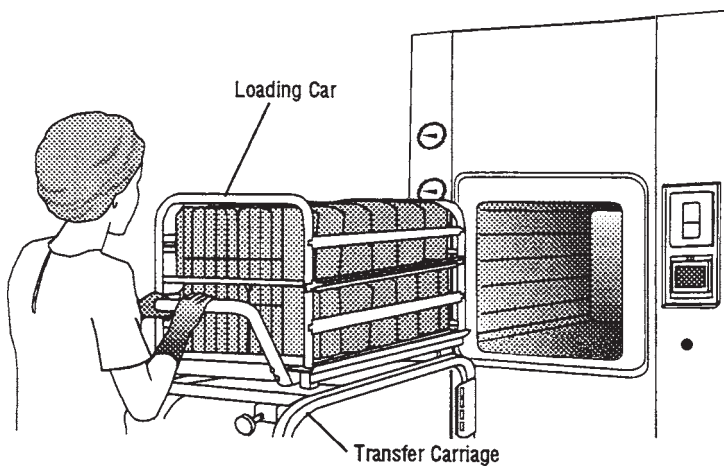

Figure 5-2. Align Loading Car with Chamber Opening

6.3 Prevacuum Cycle Operation

WARNING – EXPLOSION HAZARD: This sterilizer is not designed to process flammable liquids.

Pressing **OPTIONS** advances display to the first Out of Cycle Options menu (screen #13).

Pressing **TEST CYCLES** advances display to screen #3.

Pressing **MAIN MENU** returns display to screen #1.

The Prevacuum cycle is designed for sterilizing heat- and moisture-stable materials at 100° to 138°C (212° to 280°F).

1. Before running this cycle, refer to *SECTION 6.1, BEFORE OPERATING STERILIZER* and *SECTION 6.2, UNLOADING THE STERILIZER* at beginning of this section.
2. Press **CYCLE SELECT** on screen #1.

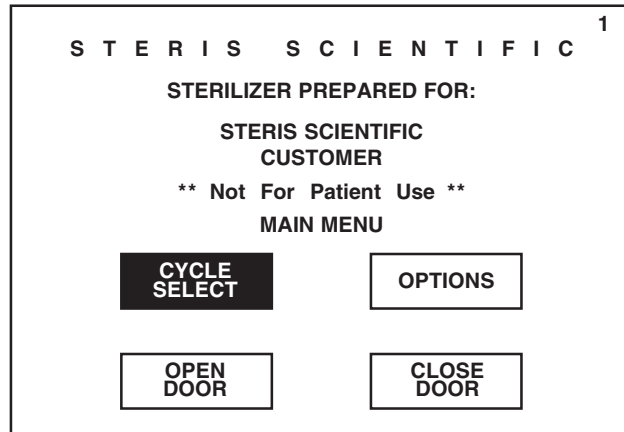

3. Press **PREVAC** button.

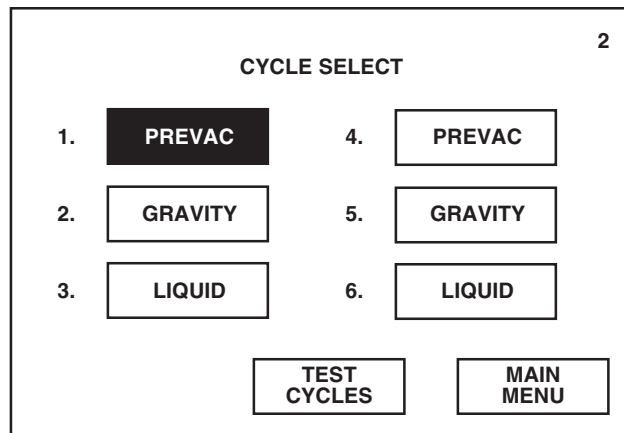

- Verify cycle parameters listed for the selected Prevacuum cycle are acceptable.

If listed cycle parameters are not acceptable, press **PREVIOUS** button and refer to *SECTION 8, PROGRAMMING CYCLE VALUES*, for instructions on changing cycle parameters.

Pressing **PREVIOUS** returns display to screen #2.

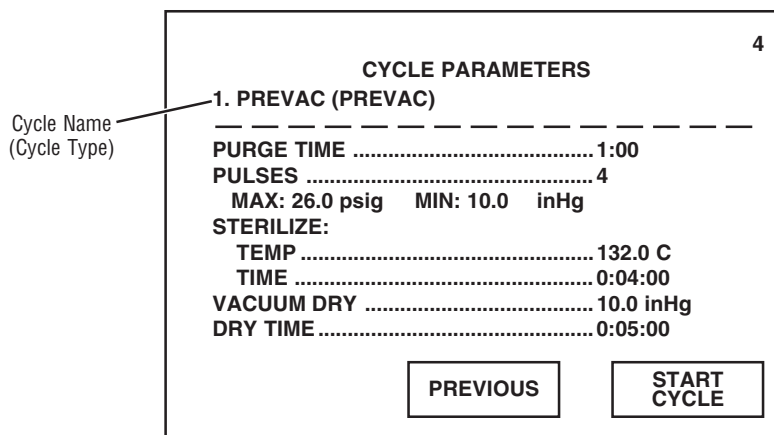

- To begin Prevacuum cycle operation, press **START CYCLE**.

*NOTE: If **START CYCLE** is pressed while the chamber door is open, a display screen will appear directing the operator to close door before continuing cycle operation. Operator must reselect the cycle after door is closed.*

NOTE: If a cycle is started when the sterilizer has not been fully calibrated, a display screen will appear indicating that the control is not calibrated. Sterilizer must be calibrated by a qualified service technician before processing loads.

- Sterilizer automatically progresses through the following cycle phases.

*NOTE: If an alarm occurs during cycle operation, refer to *SECTION 11, ROUTINE MAINTENANCE*, for instructions on correcting the alarm condition.*

NOTE: If power is lost during cycle operation, cycle either continues in same phase or aborts if seal pressure is below 5 psig once power is restored.

- Jacket Charge** – Jacket charges with steam to 1° less than the programmed sterilize temperature.

Pressing **ABORT** advances display to screen #11. Refer to "Aborting Cycles", later in this section.

Pressing **STATUS PRINT** generates a printout of the current sterilizer chamber status.

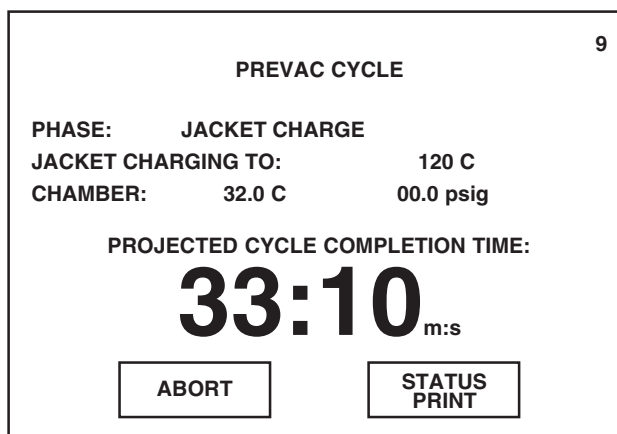

- **Activate Seal** – Door seal fills with steam and expands against the sterilizer door opening, forming an air tight seal.

Pressing **ABORT** advances display to screen #11. Refer to SECTION 6.9, *ABORTING CYCLES*.

Pressing **STATUS PRINT** generates a printout of the current sterilizer chamber status.

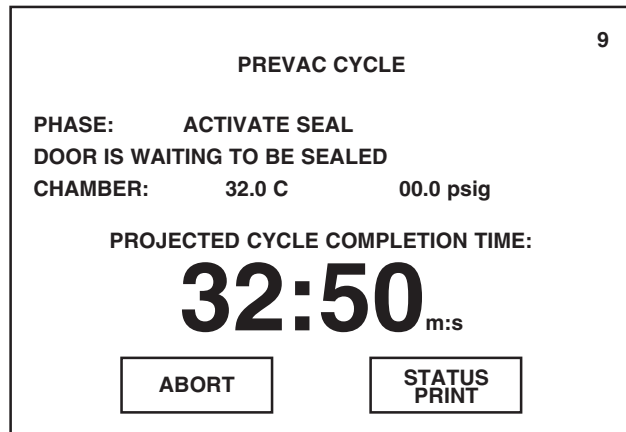

- **Purge** – Steam flows through the chamber for the programmed time interval.

Pressing **ABORT** advances display to screen #11. Refer to SECTION 6.9, *ABORTING CYCLES*.

Pressing **STATUS PRINT** generates a printout of the current sterilizer chamber status.

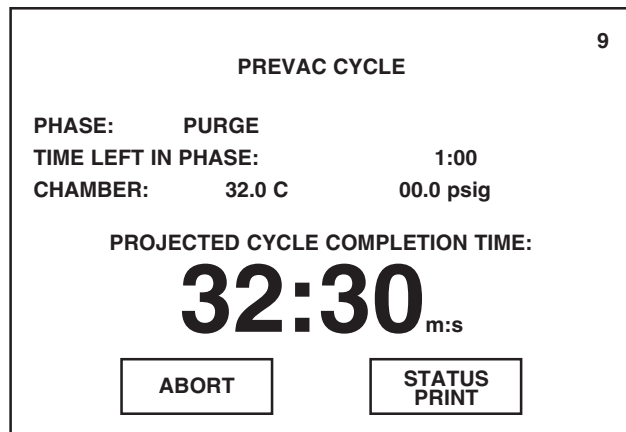

NOTE: The projected cycle completion time shown on the display is estimated. The control automatically evaluates the cycle progress and corrects the estimated time at the beginning of each phase.

NOTE: Current time, chamber pressure and chamber temperature are printed at each transition point.

- **Vacuum Pulse Exhaust** – Chamber is exhausted to 4 psig.

NOTE: The sterilizer can be programmed to pull up to 99 pulses during the Prevacuum cycle. Refer to SECTION 8, PROGRAMMING CYCLE VALUES.

Pressing ABORT advances display to screen #11. Refer to SECTION 6.9, ABORTING CYCLES.

Pressing STATUS PRINT generates a printout of the current sterilizer chamber status.

PREVAC CYCLE		9
PHASE:	VACUUM PULSE #1	
EXHAUSTING TO:	4.0 psig	
CHAMBER:	75.0 C	10.0 psig
PROJECTED CYCLE COMPLETION TIME:		
31:00 _{m:s}		
ABORT	STATUS PRINT	

- **Vacuum Pulse Evacuate** – A vacuum is drawn in the chamber to the programmed minimum pressure parameter.

Pressing ABORT advances display to screen #11. Refer to SECTION 6.9, ABORTING CYCLES.

Pressing STATUS PRINT generates a printout of the current sterilizer chamber status.

PREVAC CYCLE		9
PHASE:	VACUUM PULSE #1	
EXHAUSTING TO:	10.0 inHg	
CHAMBER:	75.0 C	8.0 inHg
PROJECTED CYCLE COMPLETION TIME:		
29:40 _{m:s}		
ABORT	STATUS PRINT	

- **Charge Pulse** – Chamber charges with steam to the programmed maximum pressure parameter.

Pressing ABORT advances display to screen #11. Refer to SECTION 6.9, ABORTING CYCLES.

Pressing STATUS PRINT generates a printout of the current sterilizer chamber status.

PREVAC CYCLE		9
PHASE:	CHARGE PULSE #1	
STEAM CHARGING TO:	26.0 psig	
CHAMBER:	65.0 C	10.0 inHg
PROJECTED CYCLE COMPLETION TIME:		
29:00 _{m:s}		
ABORT	STATUS PRINT	

- **Charge** – After the last prevacuum pulse, chamber charges with steam to the programmed sterilize temperature.

Pressing **ABORT** advances display to screen #11. Refer to SECTION 6.9, *ABORTING CYCLES*.

Pressing **STATUS PRINT** generates a printout of the current sterilizer chamber status.

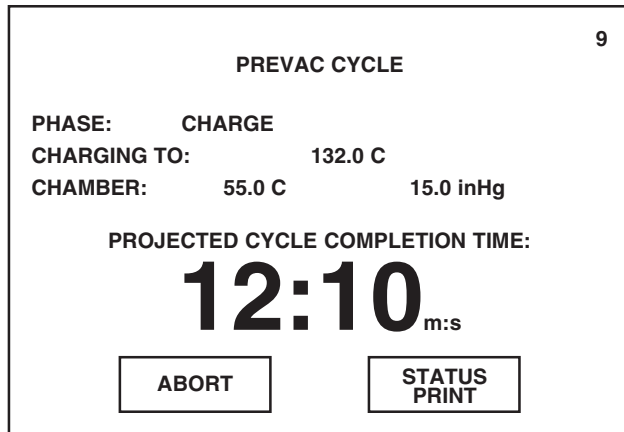

- **Sterilize** – Sterilize phase begins when chamber temperature is equal to or greater than the programmed sterilize temperature. Chamber temperature is printed every two minutes (or printed after each programmed print interval). The steam-to-jacket valve is regulated to maintain the chamber at the sterilize control temperature (control temperature = sterilize temperature + overdrive temperature).

Pressing **ABORT** advances display to screen #11. Refer to SECTION 6.9, *ABORTING CYCLES*.

Pressing **STATUS PRINT** generates a printout of the current sterilizer chamber status.

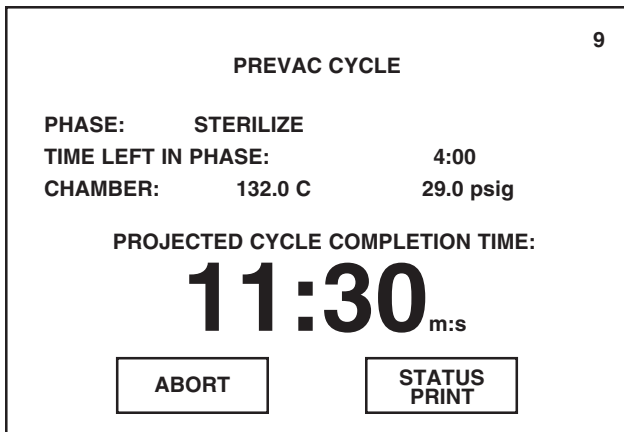

- **Fast Exhaust** – Chamber is exhausted until chamber pressure reaches 4 psig.

Pressing **ABORT** advances display to screen #11. Refer to SECTION 6.9, *ABORTING CYCLES*.

Pressing **STATUS PRINT** generates a printout of the current sterilizer chamber status.

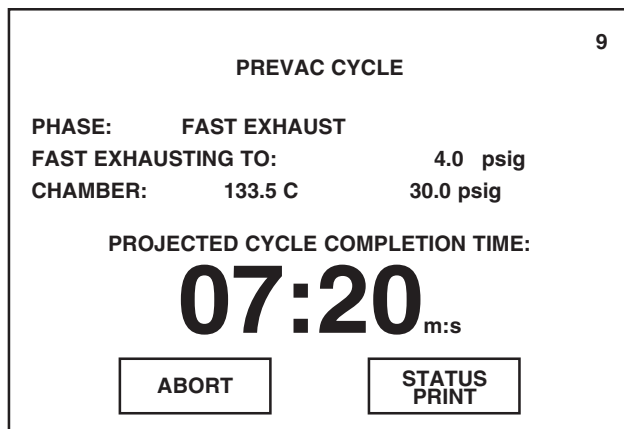

- **Vacuum Dry** – A vacuum is drawn in the chamber to the programmed vacuum dry point.

Pressing **ABORT** advances display to screen #11. Refer to SECTION 6.9, **ABORTING CYCLES**.

Pressing **STATUS PRINT** generates a printout of the current sterilizer chamber status.

PREVAC CYCLE		9
PHASE:	VACUUM DRY	
EVACUATING TO:	83.5 C	10.0 inHg
CHAMBER:	83.5 C	2.0 psig
PROJECTED CYCLE COMPLETION TIME:		
06:10 m:s		
ABORT	STATUS PRINT	

NOTE: If dry time is programmed for 0 minutes, cycle will automatically skip the Vacuum Dry, Dry and Air Break phases, retract door seal and remove vapors for 1 minute before completing cycle.

- **Dry** – Dry phase begins once vacuum level in chamber reaches the programmed vacuum dry point. Chamber then continues to evacuate for the programmed time interval.

Pressing **ABORT** advances display to screen #11. Refer to SECTION 6.9, **ABORTING CYCLES**.

Pressing **STATUS PRINT** generates a printout of the current sterilizer chamber status.

PREVAC CYCLE		9
PHASE:	DRY	
TIME LEFT IN PHASE:	83.5 C	5:00
CHAMBER:	83.5 C	10.0 inHg
PROJECTED CYCLE COMPLETION TIME:		
05:30 m:s		
ABORT	STATUS PRINT	

- **Air Break** – Filtered air enters the chamber to relieve the vacuum within the chamber.

Pressing **ABORT** advances display to screen #11. Refer to SECTION 6.9, **ABORTING CYCLES**.

Pressing **STATUS PRINT** generates a printout of the current sterilizer chamber status.

PREVAC CYCLE		9
PHASE:	AIR BREAK	
AIR BREAK TO:	83.5 C	2.0 inHg
CHAMBER:	83.5 C	25.0 inHg
PROJECTED CYCLE COMPLETION TIME:		
00:30 m:s		
ABORT	STATUS PRINT	

- **Retract Seal** – Steam is exhausted from the door seal.

Pressing **ABORT** advances display to screen #11. Refer to SECTION 6.9, **ABORTING CYCLES**.

Pressing **STATUS PRINT** generates a printout of the current sterilizer chamber status.

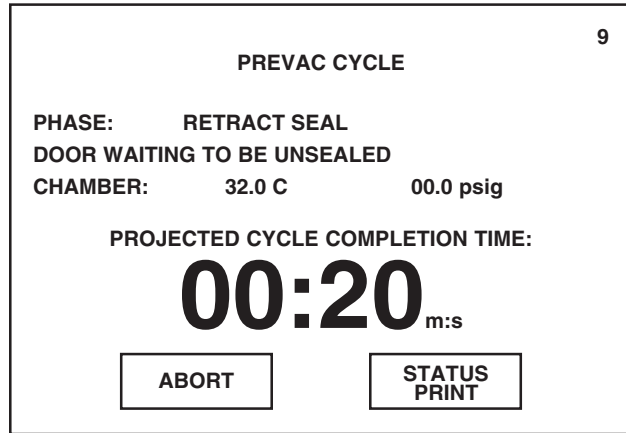

*NOTE: If sterilizer is equipped with double doors and interlock type 1 or 3 is programmed for this cycle, operator must select which door to unseal by pressing **UNSEAL DOOR** on the appropriate touch screen. Refer to Section 7 for description of interlock types.*

- **Complete** – The complete tone sounds and the cycle summary and end-of-cycle messages are printed.

Pressing **ABORT** advances display to screen #11. Refer to SECTION 6.9, **ABORTING CYCLES**.

Pressing **STATUS PRINT** generates a printout of the current sterilizer chamber status.

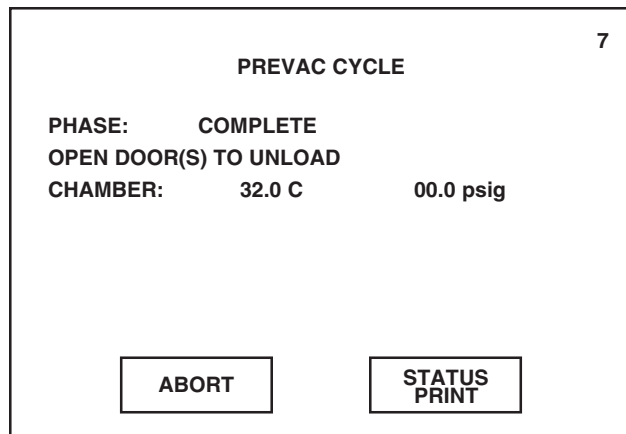

7. Once cycle is complete, open chamber door and unload sterilizer. Display returns to the main menu (screen #1).

⚠ WARNING – BURN HAZARD: Sterilizer, rack/shelves, and loading car will be hot after cycle is run. Always wear protective gloves and apron (also a face shield, if processing liquids) when removing a processed load. Protective gloves and apron must be worn when reloading sterilizer following the previous operation.

⚠ WARNING – SLIPPING HAZARD: To prevent falls, keep floors dry by immediately wiping up any spilled liquids or condensation in sterilizer loading and unloading areas.

6.4 Gravity Cycle Operation

The Gravity cycle is designed for sterilizing heat- and moisture-stable goods at 100° to 138°C (212° to 280°F).

1. Before running this cycle, refer to "Before Operating Sterilizer" and "Load Sterilizer" at beginning of this section.
2. Press **CYCLE SELECT** on screen #1.

⚠ WARNING – EXPLOSION HAZARD: This sterilizer is not designed to process flammable liquids.

Pressing **OPTIONS** advances display to the first Out of Cycle Options menu (screen #13).

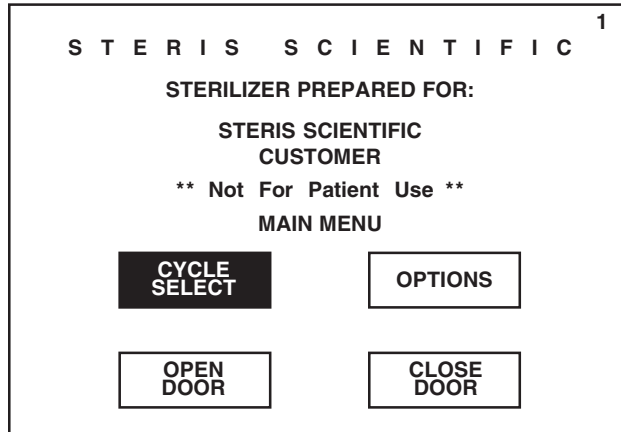

3. Press **GRAVITY** button.

Pressing **TEST CYCLES** advances display to screen #3.

Pressing **MAIN MENU** returns display to screen #1.

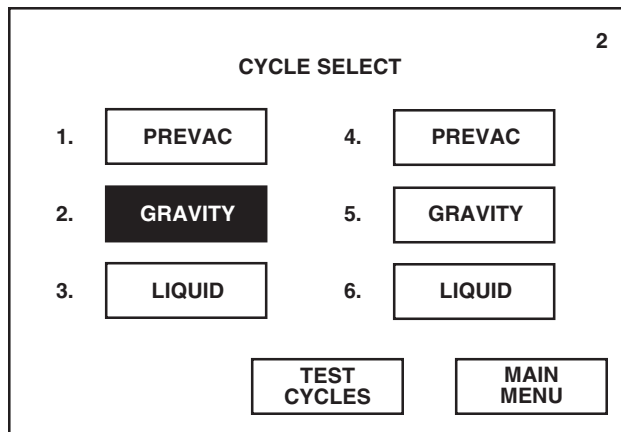

4. Verify cycle parameters listed for the selected Gravity cycle are acceptable.

If listed cycle parameters are not acceptable, press **PREVIOUS** button and refer to *SECTION 8, PROGRAMMING CYCLE VALUES*, for instructions on changing cycle parameters.

Pressing **PREVIOUS** returns display to screen #2.

Cycle Name
(Cycle Type)

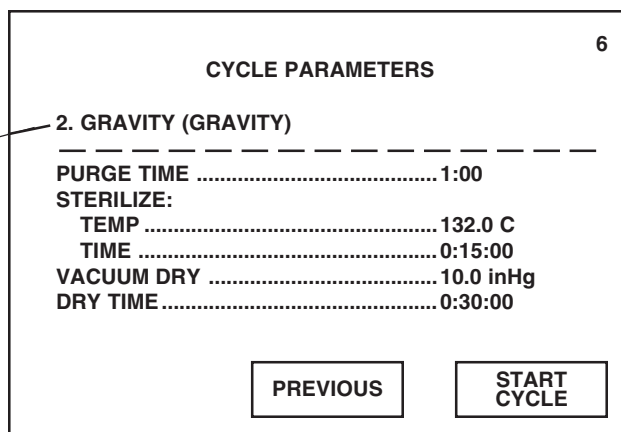

5. To begin Gravity cycle operation, press **START CYCLE**.

*NOTE: If **START CYCLE** is pressed while the chamber door is open, a display screen will appear directing the operator to close door before continuing cycle operation. Operator must reselect the cycle after door is closed.*

NOTE: If a cycle is started when the sterilizer has not been fully calibrated, a display screen will appear indicating that the control is not calibrated. Sterilizer must be calibrated by a qualified service technician before processing loads.

Pressing **PREVIOUS** returns display to screen #2.

CYCLE PARAMETERS		6
2. GRAVITY (GRAVITY)		

PURGE TIME	1:00	
STERILIZE:		
TEMP	132.0 C	
TIME	0:15:00	
VACUUM DRY	10.0 inHg	
DRY TIME	0:30:00	
PREVIOUS		START CYCLE

6. Sterilizer automatically progresses through the following cycle phases.

NOTE: If an alarm occurs during cycle operation, refer to SECTION 11, ROUTINE MAINTENANCE, for instructions on correcting the alarm condition

NOTE: If power is lost during cycle operation, cycle either continues in same phase or aborts if seal pressure is below 5 psig once power is restored.

- **Jacket Charge** – Jacket charges with steam to 1° less than the programmed sterilize temperature.
- **Activate Seal** – Door seal fills with steam and expands against the sterilizer door opening, forming an air tight seal.

Pressing **ABORT** advances display to screen #11. Refer to SECTION 6.9, **ABORTING CYCLES**.

Pressing **STATUS PRINT** generates a printout of the current sterilizer chamber status.

GRAVITY CYCLE		9
PHASE:	JACKET CHARGE	
JACKET CHARGING TO:	120 C	
CHAMBER:	32.0 C	00.0 psig
PROJECTED CYCLE COMPLETION TIME:		
47:50 m:s		
ABORT		STATUS PRINT

- **Purge** – Steam flows through the chamber for the programmed time interval.

NOTE: The projected cycle completion time shown on the display is

Pressing ABORT advances display to screen #11. Refer to SECTION 6.9, ABORTING CYCLES.

Pressing STATUS PRINT generates a printout of the current sterilizer chamber status.

GRAVITY CYCLE		9
PHASE:	ACTIVATE SEAL	
DOOR IS WAITING TO BE SEALED		
CHAMBER:	32.0 C	00.0 psig
PROJECTED CYCLE COMPLETION TIME:		
47:30 _{m:s}		
ABORT	STATUS PRINT	

estimated. The control automatically evaluates the cycle progress and corrects the estimated time at the beginning of each phase.

Pressing ABORT advances display to screen #11. Refer to SECTION 6.9, ABORTING CYCLES.

Pressing STATUS PRINT generates a printout of the current sterilizer chamber status.

GRAVITY CYCLE		9
PHASE:	PURGE	
TIME LEFT IN PHASE:	1:00	
CHAMBER:	32.0 C	00.0 psig
PROJECTED CYCLE COMPLETION TIME:		
47:10 _{m:s}		
ABORT	STATUS PRINT	

NOTE: Current time, chamber pressure and chamber temperature are printed at each transition point.

- **Charge** – Chamber charges with steam to the programmed sterilize temperature.

Pressing **ABORT** advances display to screen #11. Refer to SECTION 6.9, *ABORTING CYCLES*.

Pressing **STATUS PRINT** generates a printout of the current sterilizer chamber status.

GRAVITY CYCLE		9
PHASE:	CHARGE	
CHARGING TO:	132.0 C	
CHAMBER:	32.0 C	00.0 psig
PROJECTED CYCLE COMPLETION TIME:		
46:10 m:s		
ABORT	STATUS PRINT	

- **Sterilize** – Sterilize phase begins when chamber temperature is equal to or greater than the programmed sterilize temperature. Chamber temperature is printed every two minutes (or printed after each programmed print interval). The steam-to-jacket valve is regulated to maintain the chamber at the sterilize control temperature (control temperature = sterilize temperature + overdrive temperature).

Pressing **ABORT** advances display to screen #11. Refer to SECTION 6.9, *ABORTING CYCLES*.

Pressing **STATUS PRINT** generates a printout of the current sterilizer chamber status.

GRAVITY CYCLE		9
PHASE:	STERILIZE	
TIME LEFT IN PHASE:	15:00	
CHAMBER:	132.0 C	29.0 psig
PROJECTED CYCLE COMPLETION TIME:		
44:00 m:s		
ABORT	STATUS PRINT	

- **Fast Exhaust** – Chamber is exhausted until chamber pressure reaches 4 psig.

Pressing **ABORT** advances display to screen #11. Refer to SECTION 6.9, *ABORTING CYCLES*.

Pressing **STATUS PRINT** generates a printout of the current sterilizer chamber status.

GRAVITY CYCLE		9
PHASE:	FAST EXHAUST	
FAST EXHAUSTING TO:	4.0 psig	
CHAMBER:	133.5 C	30.0 psig
PROJECTED CYCLE COMPLETION TIME:		
38:50 m:s		
ABORT	STATUS PRINT	

- **Vacuum Dry** – A vacuum is drawn in the chamber to the programmed vacuum dry point.

Pressing **ABORT** advances display to screen #11. Refer to SECTION 6.9, **ABORTING CYCLES**.

Pressing **STATUS PRINT** generates a printout of the current sterilizer chamber status.

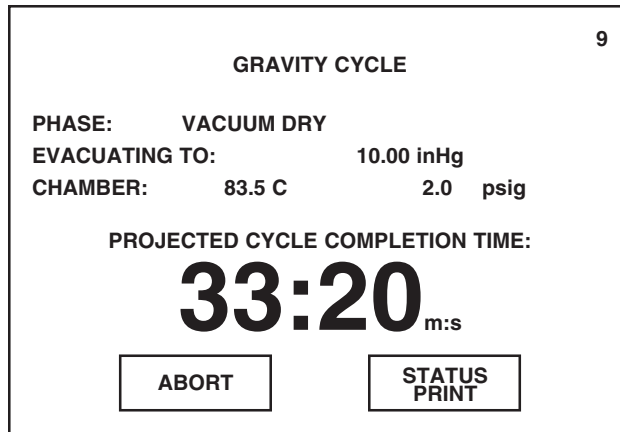

NOTE: If dry time is programmed for 0 minutes, cycle will automatically skip the Vacuum Dry, Dry and Air Break phases, retract door seal and remove vapors for 1 minute before completing cycle.

- **Dry** – Dry phase begins once vacuum level in chamber reaches the programmed vacuum dry point. Chamber then continues to evacuate for the programmed time interval.

Pressing **ABORT** advances display to screen #11. Refer to SECTION 6.9, **ABORTING CYCLES**.

Pressing **STATUS PRINT** generates a printout of the current sterilizer chamber status.

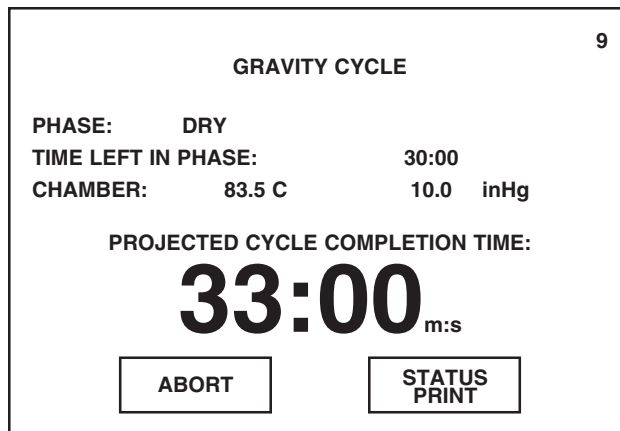

- **Air Break** – Filtered air enters the chamber to relieve the vacuum within the chamber.

Pressing **ABORT** advances display to screen #11. Refer to SECTION 6.9, **ABORTING CYCLES**.

Pressing **STATUS PRINT** generates a printout of the current sterilizer chamber status.

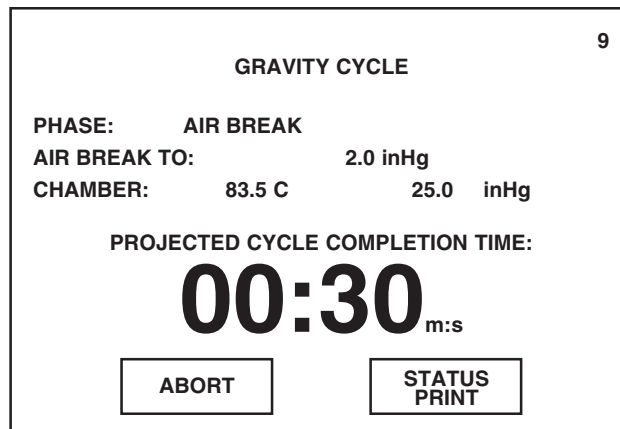

- **Retract Seal** – Steam is exhausted from the door seal.

Pressing **ABORT** advances display to screen #11. Refer to SECTION 6.9, *ABORTING CYCLES*.

Pressing **STATUS PRINT** generates a printout of the current sterilizer chamber status.

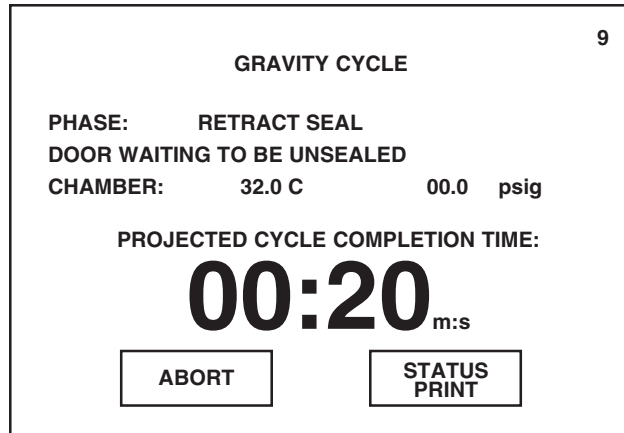

NOTE: If sterilizer is equipped with double doors and interlock type 1 or 3 is programmed for this cycle, operator must select which door to unseal by pressing UNSEAL DOOR on the appropriate touch screen. Refer to Section 7 for description of interlock types.

- **Complete** – The complete tone sounds and the cycle summary and end-of-cycle messages are printed.

Pressing **ABORT** advances display to screen #11. Refer to SECTION 6.9, *ABORTING CYCLES*.

Pressing **STATUS PRINT** generates a printout of the current sterilizer chamber status.

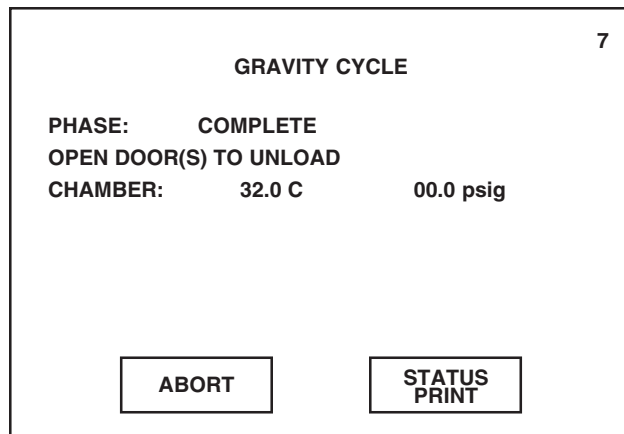

7. Once cycle is complete, open chamber door and unload sterilizer. Display returns to the main menu (screen #1).

⚠ WARNING – BURN HAZARD: Sterilizer, rack/shelves, and loading car will be hot after cycle is run. Always wear protective gloves and apron (also a face shield, if processing liquids) when removing a processed load. Protective gloves and apron must be worn when reloading sterilizer following the previous operation.

⚠ WARNING – SLIPPING HAZARD: To prevent falls, keep floors dry by immediately wiping up any spilled liquids or condensation in sterilizer loading and unloading areas.

6.5 Liquid Cycle Operation

⚠ WARNING – EXPLOSION HAZARD: This sterilizer is not designed to process flammable liquids.

⚠ WARNING – BURN HAZARD: When sterilizing liquids, you must observe the following procedures:

- It is inappropriate for a healthcare facility to sterilize liquids for direct patient contact.
- Use Liquid cycle only; no other cycle is safe for processing liquids.
- Use only vented closures.
- Use only Type I borosilicate glass bottles.
- Do not allow hot bottles to be jolted; this can cause hot-bottle explosions.

Pressing **TEST CYCLES** advances display to screen #3.

Pressing **MAIN MENU** returns display to screen #1.

Pressing **PREVIOUS** returns display to screen #2.

The Liquid cycle is designed for sterilizing liquids and media in vented borosilicate-glass or metal containers from 100° to 125°C (212° to 257°F).

1. Before running this cycle, refer to *SECTION 6.1, BEFORE OPERATING STERILIZER* and *SECTION 6.2, UNLOADING THE STERILIZER* at beginning of this section.
2. Press **CYCLE SELECT** on screen #1.

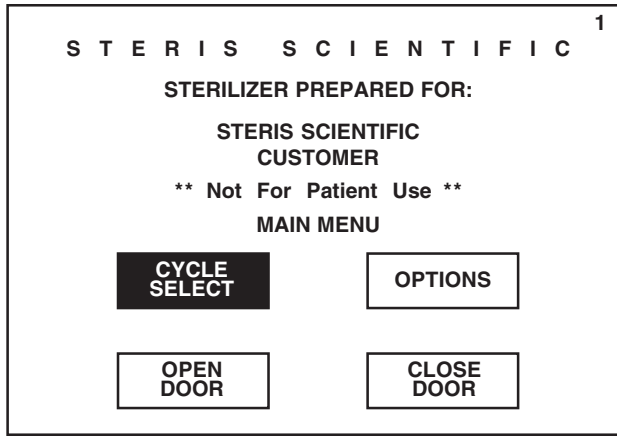

3. Press **LIQUID** button.

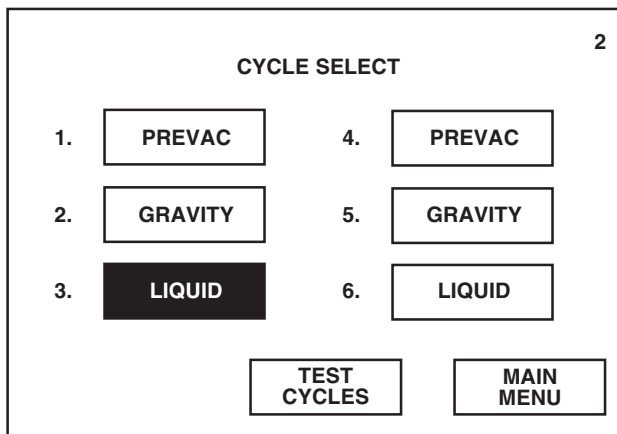

4. Verify cycle parameters listed for the selected Liquid cycle are acceptable.

If listed cycle parameters are not acceptable, press **PREVIOUS** button and refer to *SECTION 8, PROGRAMMING CYCLE VALUES*, for instructions on changing cycle parameters.

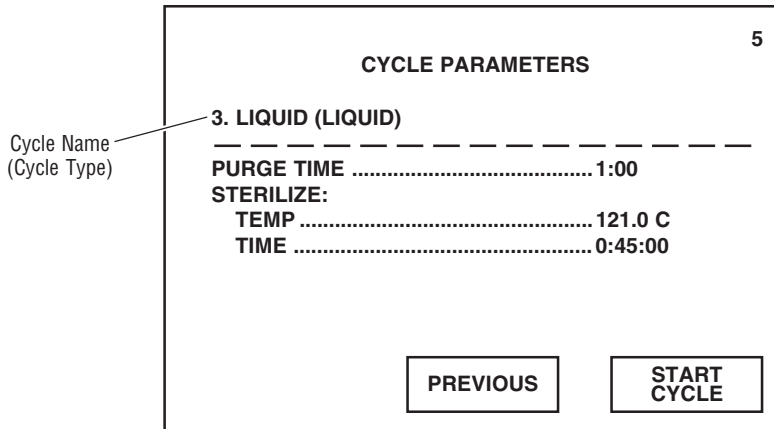

5. To begin Liquid cycle operation, press **START CYCLE**.

*NOTE: If **START CYCLE** is pressed while the chamber door is open, a display screen will appear directing the operator to close door before continuing cycle operation. Operator must reselect the cycle after door is closed.*

NOTE: If a cycle is started when the sterilizer has not been fully calibrated, a display screen will appear indicating that the control is not calibrated. Sterilizer must be calibrated by a qualified service technician before processing loads.

Pressing **PREVIOUS** returns display to screen #2.

CYCLE PARAMETERS		5
3. LIQUID (LIQUID)		

PURGE TIME	1:00	
STERILIZE:		
TEMP	121.0 C	
TIME	0:45:00	
<input type="button" value="PREVIOUS"/>		<input type="button" value="START CYCLE"/>

6. Sterilizer automatically progresses through the following cycle phases.

NOTE: If an alarm occurs during cycle operation, refer to SECTION 11, ROUTINE MAINTENANCE, for instructions on correcting the alarm condition.

NOTE: If power is lost during cycle operation, cycle either continues in same phase or aborts if seal pressure is below 5 psig once power is restored.

- **Jacket Charge** – Jacket charges with steam to 1° less than the programmed sterilize temperature.

Pressing **ABORT** advances display to screen #11. Refer to SECTION 6.9, **ABORTING CYCLES**.

Pressing **STATUS PRINT** generates a printout of the current sterilizer chamber status.

LIQUID CYCLE		9
PHASE:	JACKET CHARGE	
JACKET CHARGING TO:	120 C	
CHAMBER:	32.0 C	00.0 psig
PROJECTED CYCLE COMPLETION TIME:		
1:10 h:m		
<input type="button" value="ABORT"/>		<input type="button" value="STATUS PRINT"/>

- **Activate Seal** – Door seal fills with steam and expands against the sterilizer door opening, forming an air tight seal.

Pressing **ABORT** advances display to screen #11. Refer to SECTION 6.9, **ABORTING CYCLES**.

Pressing **STATUS PRINT** generates a printout of the current sterilizer chamber status.

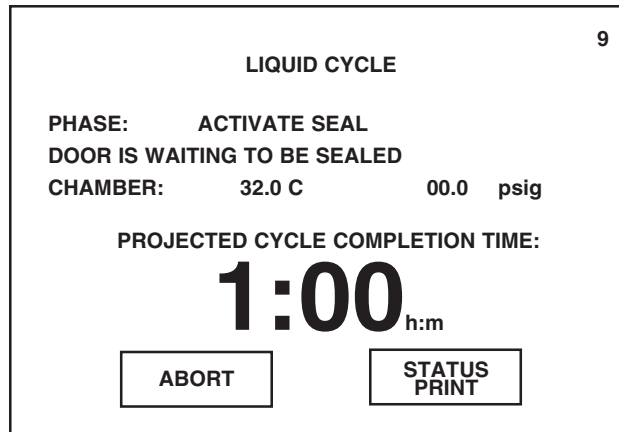

- **Purge** – Steam flows through the chamber for the programmed time interval.

Pressing **ABORT** advances display to screen #11. Refer to SECTION 6.9, **ABORTING CYCLES**.

Pressing **STATUS PRINT** generates a printout of the current sterilizer chamber status.

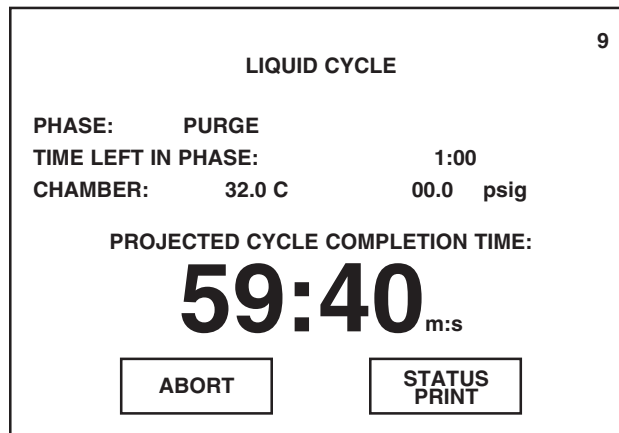

NOTE: The projected cycle completion time shown on the display is estimated. The control automatically evaluates the cycle progress and corrects the estimated time at the beginning of each phase.

NOTE: Current time, chamber pressure and chamber temperature are printed at each transition point.

- **Charge** – Chamber charges with steam to the programmed sterilize temperature.

Pressing **ABORT** advances display to screen #11. Refer to SECTION 6.9, *ABORTING CYCLES*.

Pressing **STATUS PRINT** generates a printout of the current sterilizer chamber status.

LIQUID CYCLE		9
PHASE:	CHARGE	
CHARGING TO:	121.0 C	
CHAMBER:	110.0 C	10.0 psig
PROJECTED CYCLE COMPLETION TIME:		
58:40 _{m:s}		
ABORT	STATUS PRINT	

- **Sterilize** – Sterilize phase begins when chamber temperature is equal to or greater than the programmed sterilize temperature. Chamber temperature is printed every two minutes (or printed after each programmed print interval). The steam-to-jacket valve is regulated to maintain the chamber at the sterilize control temperature (control temperature = sterilize temperature + overdrive temperature).

Pressing **ABORT** advances display to screen #11. Refer to SECTION 6.9, *ABORTING CYCLES*.

Pressing **STATUS PRINT** generates a printout of the current sterilizer chamber status.

LIQUID CYCLE		9
PHASE:	STERILIZE	
TIME LEFT IN PHASE:	30:00	
CHAMBER:	121.0 C	19.0 psig
PROJECTED CYCLE COMPLETION TIME:		
50:40 _{m:s}		
ABORT	STATUS PRINT	

- **Slow Exhaust** – Chamber is slowly exhausted until chamber pressure reaches 0 psig.

Pressing **ABORT** advances display to screen #11. Refer to SECTION 6.9, *ABORTING CYCLES*.

Pressing **STATUS PRINT** generates a printout of the current sterilizer chamber status.

LIQUID CYCLE		9
PHASE:	SLOW EXHAUST	
EXHAUSTING TO:	0.0 psig	
CHAMBER:	122.5 C	19.0 psig
PROJECTED CYCLE COMPLETION TIME:		
20:40 _{m:s}		
ABORT	STATUS PRINT	

- **Slow Evacuate** – A vacuum is slowly drawn in the chamber to 5.0 inHg. This phase ensures that the chamber is cooled to 95°C (203°F).

Pressing **ABORT** advances display to screen #11. Refer to SECTION 6.9, **ABORTING CYCLES**.

Pressing **STATUS PRINT** generates a printout of the current sterilizer chamber status.

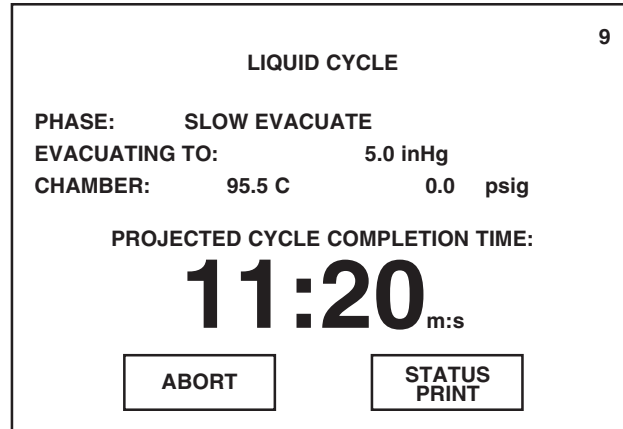

- **Vapor Removal** – Filtered air enters the chamber to relieve the vacuum within the chamber. Steam is exhausted from the door seal. Chamber vapor vents, through slight opening between seal and door, into the sterilizer cabinet for six minutes.

Pressing **ABORT** advances display to screen #11. Refer to SECTION 6.9, **ABORTING CYCLES**.

Pressing **STATUS PRINT** generates a printout of the current sterilizer chamber status.

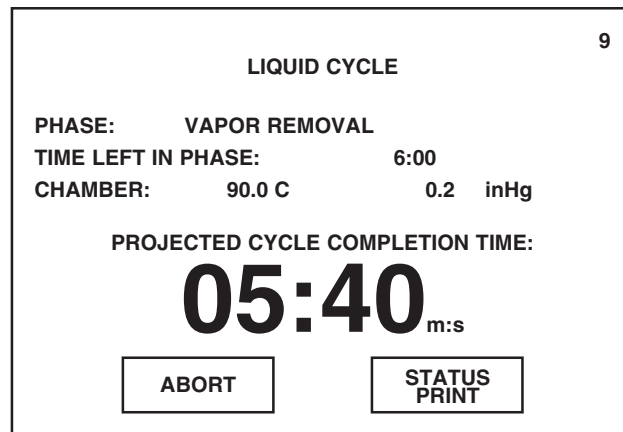

- **Complete** – The complete tone sounds and the cycle summary and end-of-cycle messages are printed.

Pressing **ABORT** advances display to screen #11. Refer to SECTION 6.9, **ABORTING CYCLES**.

Pressing **STATUS PRINT** generates a printout of the current sterilizer chamber status.

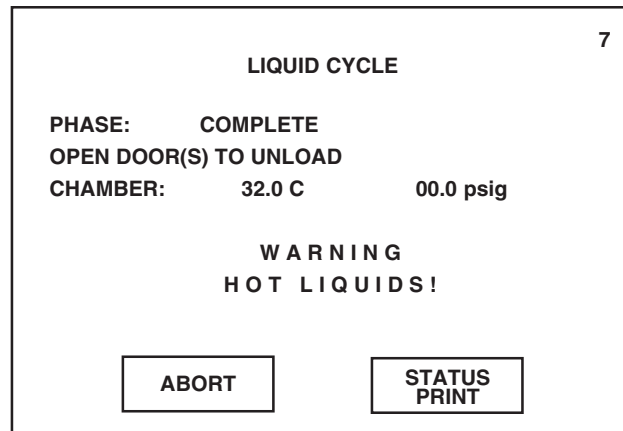

⚠ WARNING – BURN HAZARD: Sterilizer, rack/shelves, and loading car will be hot after cycle is run. Always wear protective gloves and apron (also a face shield, if processing liquids) when removing a processed load. Protective gloves and apron must be worn when re-loading sterilizer following the previous operation.

⚠ WARNING – BURN HAZARD: When sterilizing liquids, you must observe the following:

- It is inappropriate for a healthcare facility to sterilize liquids for direct patient contact.
- Do not allow hot bottles to be jolted; this can cause hot-bottle explosions.

⚠ WARNING – SLIPPING HAZARD: To prevent falls, keep floors dry by immediately wiping up any spilled liquids or condensation in the sterilizer loading or unloading area.

7. Once cycle is complete, open chamber door and unload sterilizer. Display returns to the main menu (screen #1).

6.6 Leak Test Cycle Operation

⚠ WARNING – STERILITY ASSURANCE HAZARD:

- Load sterility may be compromised if the biological air removal or air leak test indicates a potential problem. If these indicators show a potential problem, refer the situation to a qualified service technician before using the sterilizer.
- According to AAMI standards, a measured leak rate greater than 1 mm Hg/minute indicates a problem with the sterilizer. Refer the situation to a qualified service technician before using the sterilizer further.

The Vacuum Leak Test cycle is designed to measure the integrity of the sealed pressure vessel and associated piping. During this cycle, the control automatically checks for vacuum leaks in the piping and door seal. Leak Test cycle can also be used to confirm that the sterilizer piping is intact after performing repairs.

NOTE: This test is not a substitute for the DART (Bowie-Dick) test.

If sterilizer fails the leak test, the sterilizer must be inspected by a qualified service technician.

NOTE: The measured leak rate (mm Hg per minute) is calculated by the control over a timed 10 minute period and is included on the cycle printout. A leak rate of 1 mm Hg/minute or less is considered acceptable.

Leak Test cycle is preprogrammed, the cycle parameters are fixed and cannot be changed.

The Vacuum Leak Test cycle must be run at least once each week, and should be run as the first cycle of the day.

1. Before running this cycle, refer to *SECTION 6.1, BEFORE OPERATING STERILIZER* at beginning of this section.

NOTE: If sterilizer is equipped with double doors, the interlock type for Leak Test cycle is factory set and fixed at Type #1. Refer to SECTION 8 for description of interlock types.

2. Press **CYCLE SELECT** on screen #1.

Pressing OPTIONS advances display to the first Out of Cycle Options menu (screen #13).



3. Press **TEST CYCLES** button.

Pressing MAIN MENU returns display to screen #1.

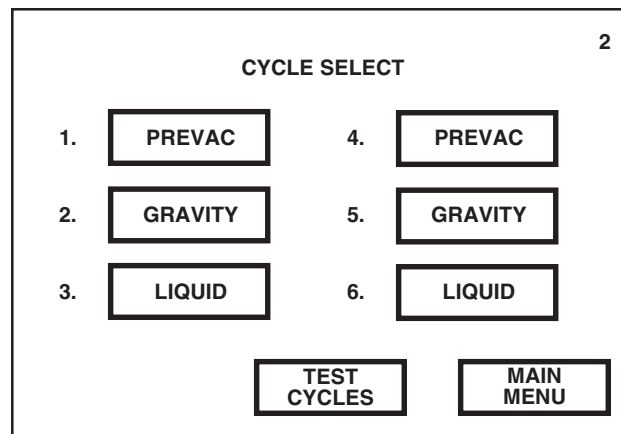

4. To begin Leak Test, press **LEAK TEST**.

Pressing STANDARD CYCLES returns display to screen #2.

Pressing MAIN MENU returns display to screen #1.

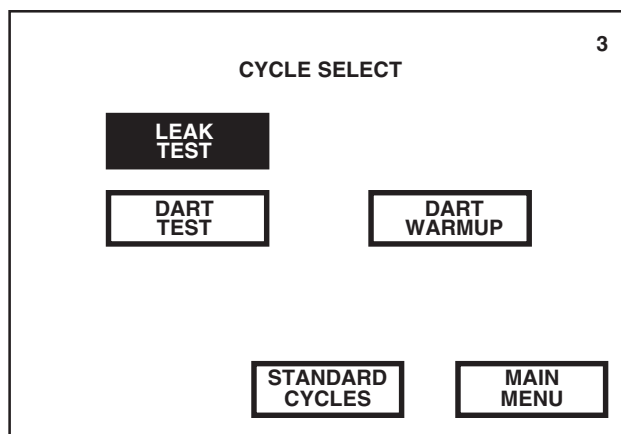

NOTE: If LEAK TEST is pressed while the chamber door is open, a display screen will appear directing the operator to close door before continuing cycle operation. Operator must reselect LEAK TEST after the door is closed.

NOTE: If a cycle is started when the sterilizer has not been fully calibrated, a display screen will appear indicating that the control is not calibrated. Sterilizer must be calibrated by a qualified service technician before processing loads.

5. Sterilizer automatically progresses through the following cycle phases.

NOTE: If an alarm occurs during cycle operation, refer to SECTION 11, ROUTINE MAINTENANCE, for instructions on correcting the alarm condition.

NOTE: If power is lost during cycle operation, cycle either continues in same phase or aborts if seal pressure is below 5 psig once power is restored.

- **Jacket Charge** – Jacket charges with steam to 131°C (268°F).
- **Activate Seal** – Door seal fills with steam and expands against the sterilizer door opening, forming an air tight seal.
- **Purge** – Steam flows through the chamber for one minute.

NOTE: The projected cycle completion time shown on the display is estimated. The control automatically evaluates the cycle progress and corrects the estimated time at the beginning of each phase.

NOTE: Current time, chamber pressure and chamber temperature are printed at each transition point.

- **Vacuum Pulse #1 Exhaust** – Chamber is exhausted to 4 psig.
- **Vacuum Pulse #1 Evacuate** – A vacuum is drawn in the chamber to 10 inHg.
- **Charge Pulse #1** – Chamber charges with steam up to 26 psig.
- **Vacuum Pulse #2 Exhaust** – Chamber is exhausted to 4 psig.
- **Vacuum Pulse #2 Evacuate** – A vacuum is drawn in the chamber to 10 inHg.
- **Charge Pulse #2** – Chamber charges with steam up to 26 psig.
- **Charge** – After the last prevacuum pulse, chamber charges with steam to 132°C (270°F).
- **Evacuate** – Chamber exhausts and a vacuum is drawn in the chamber for 10 minutes.
- **Stabilize** – The chamber stabilizes for 2 minutes. This phase ensures a constant vacuum level after the vacuum system has been turned off.
- **Leak Test** – The chamber remains idle for 10 minutes. On completion of phase, control calculates the leak rate based on the initial and final pressure readings taken during the 10 minute period.
- **Air Break** – Filtered air enters the chamber to relieve the vacuum within the chamber.
- **Retract Seal** – Steam is exhausted from the door seal.

- **Complete** – The complete tone sounds and the cycle summary and end-of-cycle messages are printed. Display returns to the main menu (screen #1).

6. Once the sterilizer completes and passes the Leak Test cycle, the unit can be safely used for weekly processing.

NOTE: Sequential records of tests should be kept to detect if any major changes in leak rates are occurring. Maintenance can then be scheduled to correct any loose fittings, bad gaskets, etc.

6.7 DART Warmup Cycle Operation

The DART Warm-up cycle is designed to bring the chamber up to operating temperature in preparation for the DART (Bowie-Dick) Test cycle.

DART Warm-up cycle is preprogrammed, and cycle parameters are fixed and cannot be changed by the customer.

The DART Warm-up cycle should be run as the first cycle of the day, prior to performing a DART Test cycle.

1. Before running this cycle, refer to *SECTION 6.1, BEFORE OPERATING STERILIZER*.

NOTE: If sterilizer is equipped with double doors, the interlock type for DART Warm-up cycle is factory set and fixed at Type #1. Refer to SECTION 8 for description of interlock types.

2. Press **CYCLE SELECT** on screen #1.

Pressing OPTIONS advances display to the first Out of Cycle Options menu (screen #13).



3. Press **TEST CYCLES** button.

Pressing **MAIN MENU** returns display to screen #1.

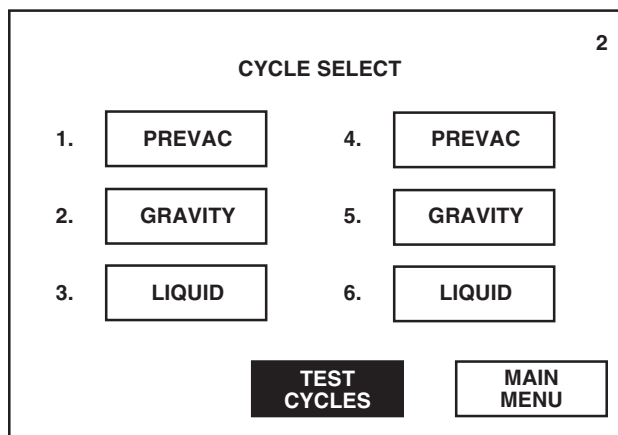

4. To begin DART Warm-up, press **DART WARM-UP**.

Pressing **STANDARD CYCLES** returns display to screen #2.

Pressing **MAIN MENU** returns display to screen #1.

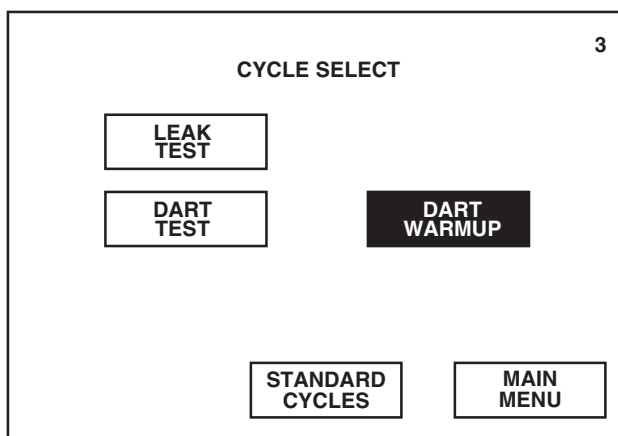

NOTE: If **DART WARM-UP** is pressed while the chamber door is open, a display screen will appear directing the operator to close door before continuing cycle operation. Operator must reselect DART Warm-up after the door is closed.

NOTE: If a cycle is started when the sterilizer has not been fully calibrated, a display screen will appear indicating that the control is not calibrated. Sterilizer must be calibrated by a qualified service technician before processing loads.

5. Sterilizer automatically progresses through the following cycle phases.

NOTE: If an alarm occurs during cycle operation, refer to SECTION 11, ROUTINE MAINTENANCE, for instructions on correcting the alarm condition.

NOTE: If power is lost during cycle operation, cycle either continues in same phase or aborts if seal pressure is below 5 psig once power is restored.

- **Jacket Charge** – Jacket charges with steam to 131°C (268°F).
- **Activate Seal** – Door seal fills with steam and expands against the sterilizer door opening, forming an air tight seal.

- **Purge** – Steam flows through the chamber for one minute.

NOTE: The projected cycle completion time shown on the display is estimated. The control automatically evaluates the cycle progress and corrects the estimated time at the beginning of each phase.

NOTE: Current time, chamber pressure and chamber temperature are printed at each transition point.

- **Charge** – Chamber charges with steam to 132°C (270°F).
 - **Sterilize** – Sterilize phase begins when chamber temperature is equal to or greater than 132°C (270°F). Chamber temperature is printed every two minutes (or printed after each programmed print interval). The steam-to-jacket valve is regulated to maintain the chamber at 132.8°C (271°F). Duration of sterilize phase is approximately 3-1/2 minutes.
 - **Fast Exhaust** – Chamber is exhausted until chamber pressure reaches 4 psig.
 - **Vacuum Dry** – A vacuum is drawn in the chamber to the vacuum dry point.
 - **Dry** – Chamber continues to evacuate for one minute.
 - **Air Break** – Filtered air enters the chamber to relieve the vacuum within the chamber.
 - **Retract Seal** – Steam is exhausted from the door seal.
 - **Complete** – The complete tone sounds and the cycle summary and end-of-cycle messages are printed. Display returns to the main menu (screen #1).
6. Once cycle is complete, the DART Test cycle can be run. Refer to *SECTION 6.8, DART TEST CYCLE OPERATION*, next in this section.

6.8 DART Test Cycle Operation

⚠ WARNING - STERILITY ASSURANCE HAZARD: Load sterility may be compromised if the biological air removal or air leak test indicates a potential problem. If these indicators show a potential problem, refer the situation to a qualified service technician before using the sterilizer.

⚠ WARNING - PERSONAL INJURY HAZARD: When closing the chamber door, keep hands and arms out of the door opening and make sure opening is clear of any obstructions.

The DART (Bowie-Dick) Test cycle is designed to test and document the adequacy of air removal from the chamber and a sample challenge load. Refer to SECTION 3.5.2, TESTING FOR PREVACUUM EFFICIENCY in SECTION 3, TECHNIQUES OF STERILIZATION.

DART Test cycle is preprogrammed, and cycle parameters are fixed and cannot be changed by the customer.

Chamber must be at operating temperature when performing a DART Test cycle. The DART Warm-up cycle should be completed prior to performing the DART Test. Refer to SECTION 6.7, DART WARM-UP CYCLE OPERATION.

1. Before running this cycle, refer to SECTION 6.1, BEFORE OPERATING STERILIZER at beginning of this section.
2. If it is necessary to prepare a test pack refer to SECTION 3.6, DART (BOWIE-DICK) TEST, in SECTION 3, TECHNIQUES OF STERILIZATION.
3. Open chamber door and load chamber with DART pack or prepared test pack.

NOTE: If sterilizer is equipped with double doors, the interlock type for DART Test cycle is factory set and fixed at Type #1. Refer to SECTION 8 for description of interlock types.

4. Close chamber door.
5. Press **CYCLE SELECT** on screen #1.

Pressing **OPTIONS** advances display to the first Out of Cycle Options menu (screen #13).

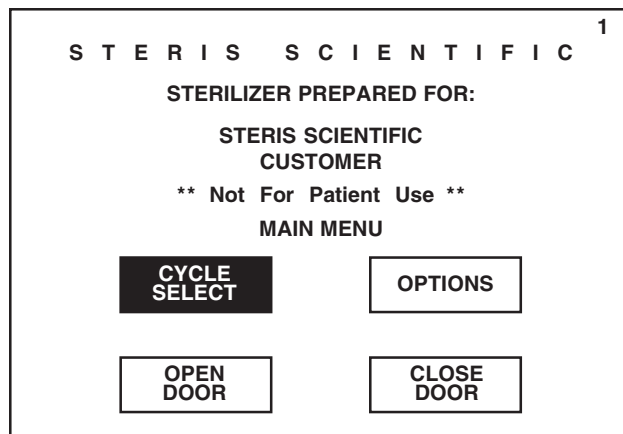

6. Press **TEST CYCLES** button.

Pressing **MAIN MENU** returns display to screen #1.

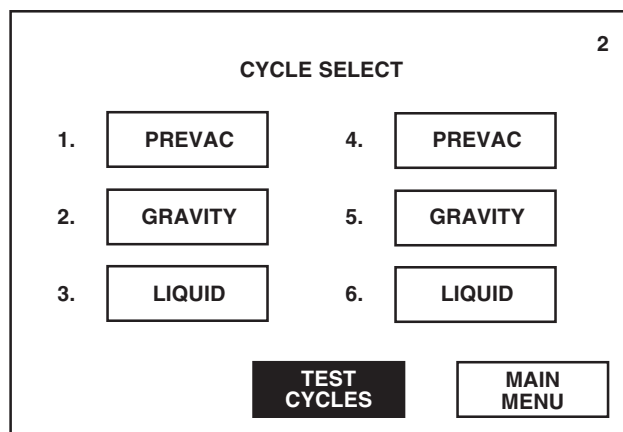

7. To begin DART Test, press **DART TEST**.

Pressing **STANDARD CYCLES** returns display to screen #2.

Pressing **MAIN MENU** returns display to screen #1.

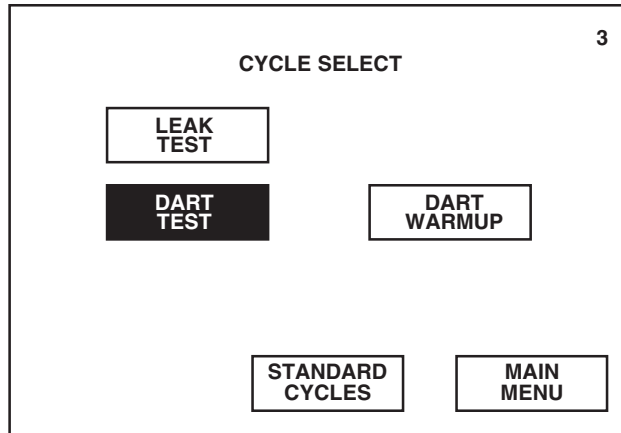

*NOTE: If DART TEST is pressed while the chamber door is open, a display screen will appear directing the operator to close door before continuing cycle operation. Operator must reselect **DART TEST** after the door is closed.*

NOTE: If a cycle is started when the sterilizer has not been fully calibrated, a display screen will appear indicating that the control is not calibrated. Sterilizer must be calibrated by a qualified service technician before processing loads.

8. Sterilizer automatically progresses through the following cycle phases.

NOTE: If an alarm occurs during cycle operation, refer to SECTION 11, ROUTINE MAINTENANCE, for instructions on correcting the alarm condition.

NOTE: If power is lost during cycle operation, cycle either continues in the same phase or aborts if seal pressure is below 5 psig once power is restored.

- **Jacket Charge** – Jacket charges with steam to 131°C (268°F).
- **Activate Seal** – Door seal fills with steam and expands against the sterilizer door opening, forming an air tight seal.
- **Purge** – Steam flows through the chamber for one minute.

NOTE: The projected cycle completion time shown on the display is estimated. The control automatically evaluates the cycle progress and corrects the estimated time at the beginning of each phase.

NOTE: Current time, chamber pressure and chamber temperature are printed at each transition point.

- **Vacuum Pulse #1 Exhaust** – Chamber is exhausted to 4 psig.
- **Vacuum Pulse #1 Evacuate** – A vacuum is drawn in the chamber to 10 inHg.
- **Charge Pulse #1** – Chamber charges with steam up to 26 psig.
- **Vacuum Pulse #2 Exhaust** – Chamber is exhausted to 4 psig.
- **Vacuum Pulse #2 Evacuate** – A vacuum is drawn in the chamber to 10 inHg.
- **Charge Pulse #2** – Chamber charges with steam up to 26 psig.

⚠ WARNING – BURN HAZARD: Sterilizer, rack/shelves, and loading car will be hot after cycle is run. Always wear protective gloves and apron (also a face shield, if processing liquids) when removing a processed load. Protective gloves and apron must be worn when reloading sterilizer following the previous operation.

⚠ WARNING – SLIPPING HAZARD: To prevent falls, keep floors dry by immediately wiping up any spilled liquids or condensation in sterilizer loading and unloading areas.

- **Charge** – After the last prevacuum pulse, chamber charges with steam to 132°C (270°F).
- **Sterilize** – Sterilize phase begins when chamber temperature is equal to or greater than 132°C (270°F). Chamber temperature is printed every two minutes (or printed after each programmed print interval). The steam-to-jacket valve is regulated to maintain the chamber at 132.8°C (271°F). Duration of sterilize phase is approximately 3-1/2 minutes.
- **Fast Exhaust** – Chamber is exhausted until chamber pressure reaches to 4 psig.
- **Vacuum Dry** – A vacuum is drawn in the chamber to the vacuum dry point.
- **Dry** – Chamber continues to evacuate for one minute.
- **Air Break** – Filtered air enters the chamber to relieve the vacuum within the chamber.
- **Retract Seal** – Steam is exhausted from the door seal.
- **Complete** – The complete tone sounds and the cycle summary and end-of-cycle messages are printed. Display returns to the main menu (screen #1).

9. Once cycle is complete, open chamber door and unload test pack.
10. Forward the exposed test pack to appropriate personnel for examination.

6.9 Aborting Cycles

While running a processing cycle, it may be necessary to end (abort) the cycle operation due to an incorrect cycle selection or a sterilizer malfunction.

A cycle can be aborted any time during normal unit operation. If a cycle is aborted, the operator/supervisor must decide if the chamber load can be reprocessed.

To abort a cycle in progress:

1. Press **ABORT** on the in-cycle status screen.

Pressing STATUS PRINT generates a printout of the current sterilizer chamber status.

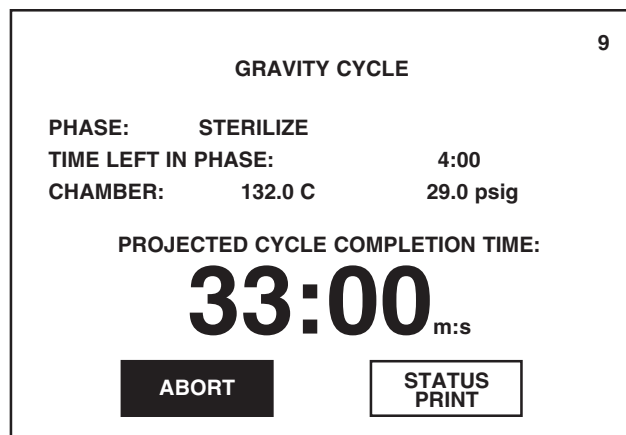

Pressing **CONTINUE CYCLE** resumes cycle operation at the point where it was interrupted. Display returns to the corresponding in-cycle status screen.

11

CYCLE ABORT ACKNOWLEDGE
ARE YOU SURE
YOU WISH TO ABORT CYCLE?

ABORT **CONTINUE CYCLE**

If the cycle is aborted, the cycle will end. The cycle will safely exhaust or air break to atmospheric pressure. A vapor removal phase will eliminate steam vapors in the chamber.

Pressing **STATUS PRINT** generates a printout of the current sterilizer chamber status.

10

GRAVITY CYCLE

PHASE: **FAST EXHAUST**
FAST EXHAUST TO: 2.0 psig
CHAMBER: 133.5 C 31.0 psig

CYCLE ABORTED.

STATUS PRINT

Pressing **STATUS PRINT** generates a printout of the current sterilizer chamber status.

10

GRAVITY CYCLE

PHASE: **AIR BREAK**
TIME LEFT IN PHASE 1:00
CHAMBER: 90.5 C 5.0 inHg

CYCLE ABORTED.

STATUS PRINT

 **WARNING – BURN HAZARD:** Sterilizer, rack/shelves, and loading car will be hot after cycle is run. Always wear protective gloves and apron (also a face shield, if processing liquids) when removing a processed load. Protective gloves and apron must be worn when reloading sterilizer following the previous operation.

 **WARNING – SLIPPING HAZARD:** To prevent falls, keep floors dry by immediately wiping up any spilled liquids or condensation in sterilizer loading and unloading areas.

2. Screen #11 allows operator a final chance to continue with the current cycle in progress instead of aborting cycle operation.

3. Press **ABORT** on screen #11. Printer records time the cycle was aborted.

If cycle is aborted while pressure is in the chamber, cycle automatically advances to the exhaust phase. Control system safely exhausts chamber and removes vapors before unsealing the chamber door.

If cycle is aborted while a vacuum is in the chamber, cycle automatically advances to the air break phase. Control system safely relieves chamber vacuum before unsealing the chamber door.

4. Once door is unsealed, display returns to the main menu (screen #1) and sterilizer may be unloaded.

IMPORTANT: The operator/supervisor must decide if the chamber load must be reprocessed after the cycle was aborted.

Life
Sciences

The access code feature is used to secure the sterilizer against unauthorized usage or programming. Separate access codes can be programmed to lock out sterilizer usage, the Change Values menu and the Supervisory mode.

NOTE: Access code is always activated for entry into the Supervisory mode. Refer to SECTION 10, OUT OF CYCLE OPTIONS, for details on the Supervisory mode.

Access codes can be issued for up to six different operators. Each operator can be assigned two separate codes; one to access sterilizer usage and one to access Change Values menu.

NOTE: Operator name and access codes are activated and assigned from the Supervisory mode. Refer to SECTION 10, OUT OF CYCLE OPTIONS.

7.1 Sterilizer Usage Locked Out

To operate sterilizer when the access code feature is activated:

1. Press the **HEXAWAVE** on screen #0.

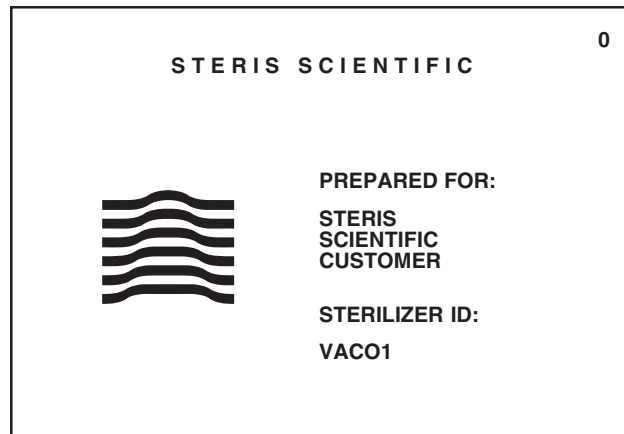

2. Press assigned **operator button**.

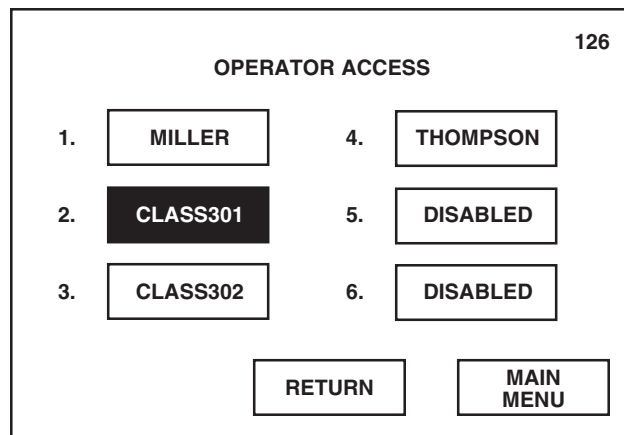

Pressing RETURN returns display to screen #0.

Pressing MAIN MENU returns display to screen #0.

NOTE: Screen #126 lists those operators which have been assigned an access code. If an operator button has not been assigned an access code, the button will read DISABLED.

- Enter assigned four-digit sterilizer access code using the numeric keypad.
Once code is correctly entered, press **ENTER**.

NOTE: If incorrect code is entered, pressing ENTER denies operator usage of the sterilizer and returns display to screen #0.

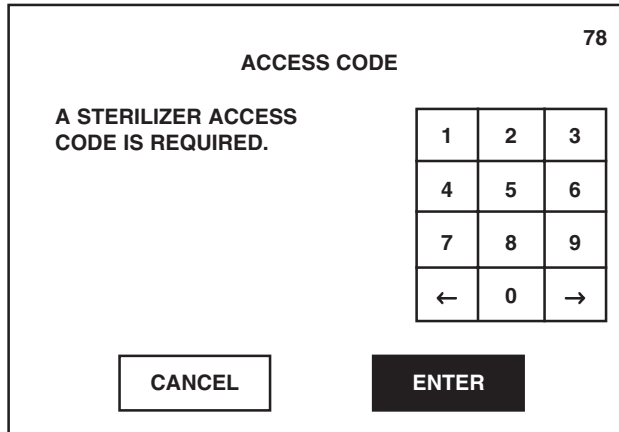

Pressing ← on numeric keypad moves the entry location to the left.

Pressing → on numeric keypad moves the entry location to the right.

Pressing CANCEL returns display to screen #0.

- Display advances to main menu (screen #1) and printer records name of operator and the date and time when sterilizer was accessed. Operator may now use the sterilizer as described in SECTION 6, STERILIZER OPERATION.

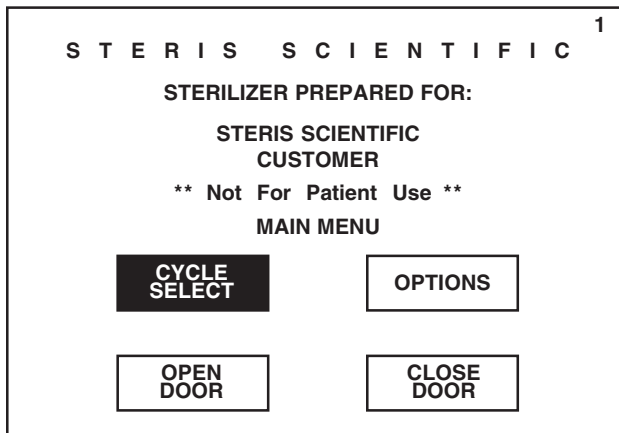

7.2 Change Values Menu Locked Out

To access the Change Values menu when the access code feature is activated:

- Press **OPTIONS** on screen #1.

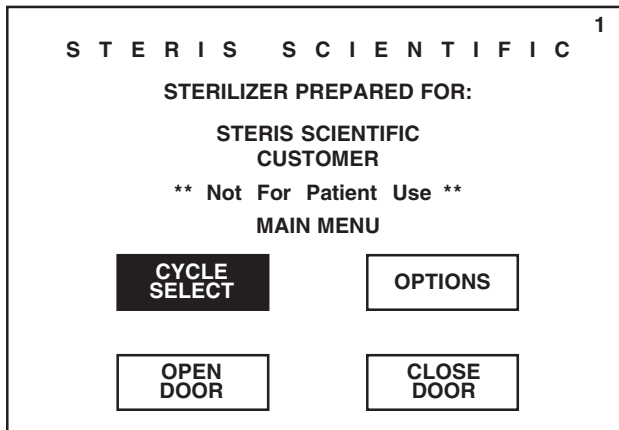

Pressing CYCLE SELECT advances display to the first Cycle Select menu (screen #2).

2. Press **CHANGE VALUES**.

Pressing **NEXT** advances display to screen #87.

Pressing **MAIN MENU** returns display to screen #1.

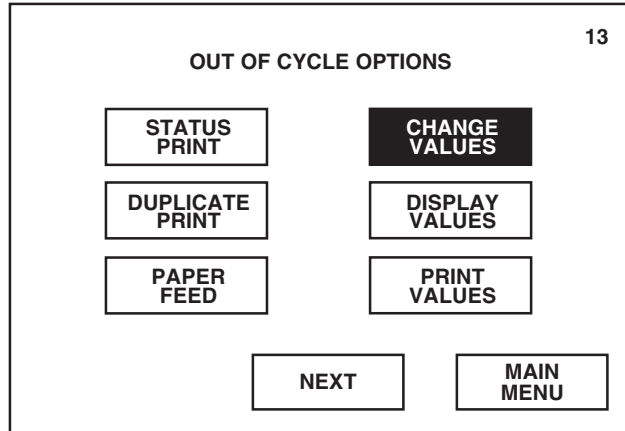

3. Press assigned **operator button**.

Pressing **RETURN** returns display to screen #13.

Pressing **MAIN MENU** returns display to screen #1.

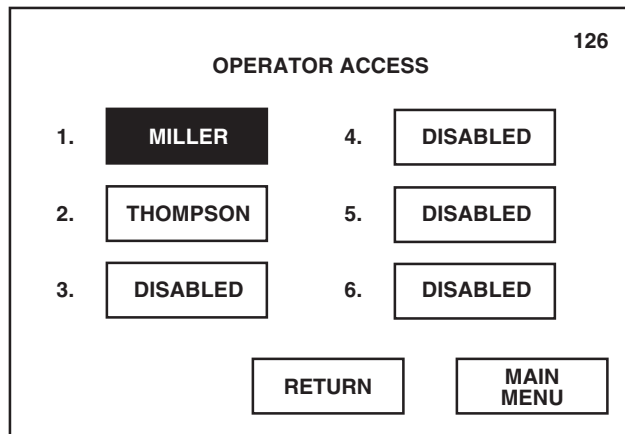

*NOTE: Screen #126 lists those operators which have been assigned an access code. If an operator button has not been assigned an access code, the button will read **DISABLED**.*

4. Enter assigned four-digit change values access code using the numeric keypad. Once code is correctly entered, press **ENTER**.

*NOTE: If incorrect code is entered, pressing **ENTER** denies access to the Change Values menu and returns display to screen #13.*

Pressing ← on numeric keypad moves the entry location to the left.

Pressing → on numeric keypad moves the entry location to the right.

Pressing **CANCEL** returns display to screen #13.

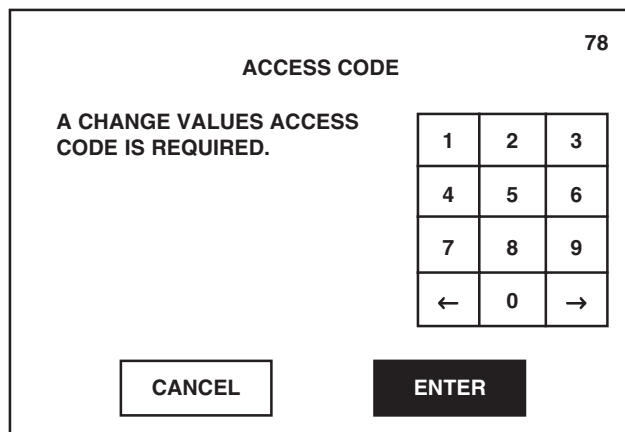

5. Display advances to the Change Values menu (screen #14) and printer records name of operator and the date and time when Change Values was accessed. Operator may now modify the cycle values and sterilizer operating parameters. Refer to *SECTION 8, PROGRAMMING CYCLE VALUES*, and *SECTION 9, PROGRAMMING OPERATING PARAMETERS*, for details on using the Change Values menu.

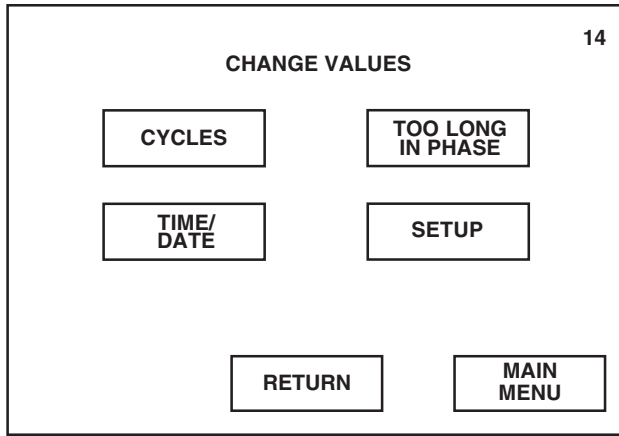

NOTE: Screen #14 lists those values and parameters which can be modified by the operator. If any of these values are locked out, the corresponding button will read "LOCKOUT".

Amsco® Century Medium Steam Sterilizers 26 x 26" (660 x 660 mm) are factory programmed with default processing cycles and cycle values (see **Table 8-1**). These preset values (parameters) can be modified to process varying loads which occur in the sterilizer's operating environment.

NOTE: Control will default to the factory-programmed values if a battery or battery-powered memory failure occurs.

This section outlines how to change the cycle values only. For details on modifying the sterilizer operating parameters, refer to *SECTION 9, PROGRAMMING OPERATING PARAMETERS*.

Table 8-1. Default Processing Cycles and Cycle Values (Parameters)

Prevacuum Cycle (Cycles 1 and 4)	Gravity Cycle (Cycles 2 and 5)	Liquid Cycle (Cycles 3 and 6)
- for sterilizing heat- and moisture-stabile materials utilizing vacuum-assisted air removal process.	- for sterilizing heat- and moisture-stabile materials.	- for sterilizing liquids and media in vented borosilicate-glass or metal containers.
Purge Time = 1:00 Pulses = 4 Max. Pressure = 26.0 psig Min. Pressure = 10.0 inHg Sterilize Time = 4:00 Sterilize Temp. = 132.0°C Overdrive = 1.5°C Under Temp. = 1.0°C Over Temp. = 6.0°C Print Interval = 2 min Vacuum Dry = 10.0 inHg Dry Time = 5:00 Interlock* = 2	Purge Time = 1:00 Sterilize Time = 15:00 Sterilize Temp. = 132°C Overdrive = 1.5°C Under Temp. = 1.0°C Over Temp. = 6.0°C Print Interval = 2 min Vacuum Dry = 10.0 inHg Dry Time = 5:00 Interlock* = 2	Purge Time = 1:00 Sterilize Time = 45:00 Sterilize Temp. = 121°C Overdrive = 1.5°C Under Temp. = 1.0°C Over Temp. = 6.0°C Print Interval = 2 min Interlock* = 2

* Double Door Units Only

8.1 Access Cycle Menu – Change Cycle Values

To modify the preset cycle values, access Cycle Menu - Change Cycle Values (screen #15) as follows:

1. Press **OPTIONS** on screen #1.

Pressing **CYCLE SELECT** advances display to the first Cycle Select menu (screen #2).

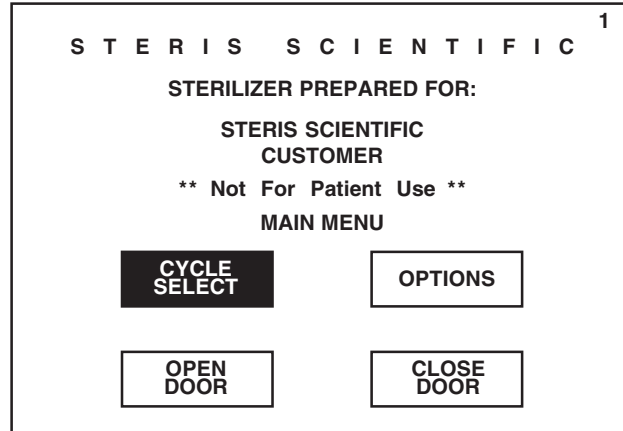

2. Press **CHANGE VALUES**. Printer records the date and time when Change Values option was selected.

Pressing **NEXT** advances display to screen #87.

Pressing **MAIN MENU** returns display to screen #1.

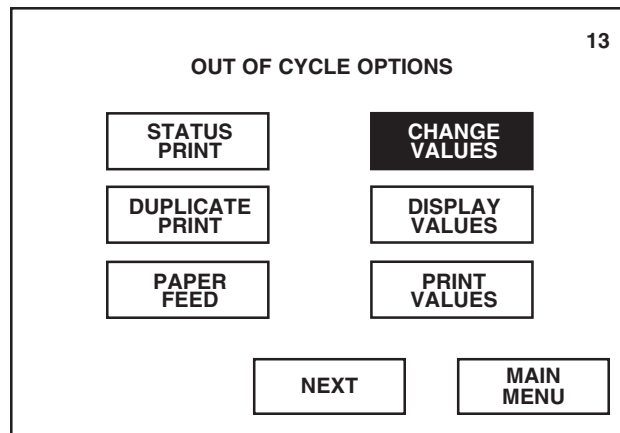

NOTE: If access code feature is activated, an assigned four-digit code must be correctly entered before operator can change values. Refer to SECTION 7, ENTERING ACCESS CODE.

3. Press **CYCLES** button.

Pressing RETURN returns display to screen #13.

Pressing MAIN MENU returns display to screen #1.

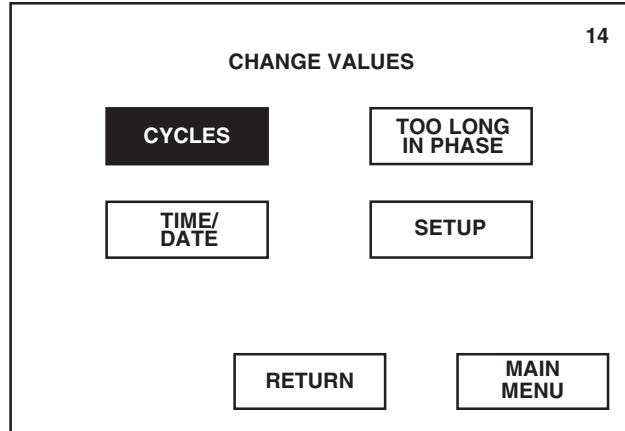

4. Screen #15 allows operator to select the cycle to be modified. Pressing the cycle button corresponding with the cycle to be changed, advances display into the Change Values procedure for that cycle.

For example: To change the values programmed for the first cycle, press 1. **PREVAC** button.

Pressing RETURN returns display to screen #14.

Pressing MAIN MENU returns display to screen #1.

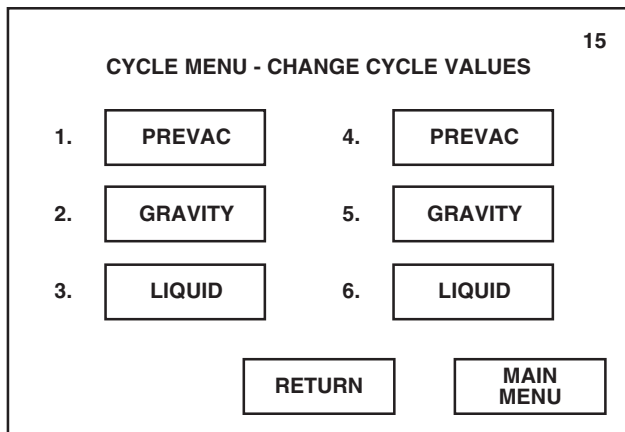

5. Refer to *SECTION 8.2, CHANGE VALUES PROCEDURE*, for a step-by-step example of changing the default Prevacuum cycle values. The procedures for changing the Gravity and Liquid cycle values are the same, with the exception that some values which can be programmed are different for each cycle.

8.2 Change Values Procedure

The Change Values procedure is used to change preset cycle values (parameters) for a particular cycle. The following procedure is an example of the Change Values procedure for a Prevacuum cycle. The cycle phase values depicted on the touch screen examples are the settings of the default Prevacuum cycle.

The procedures for changing the Gravity and Liquid cycle values are similar, with the exception that some programmable Gravity and Liquid cycle values are different.

IMPORTANT NOTE: If preset cycle values are changed, it is necessary for the operator to validate the efficacy of the changed cycle.

1. Access Cycle Menu - Change Cycle Values (screen #15) as described at the beginning of this section.
2. Press **PREVAC** button.

Pressing RETURN returns display to screen #14.

Pressing MAIN MENU returns display to screen #1.

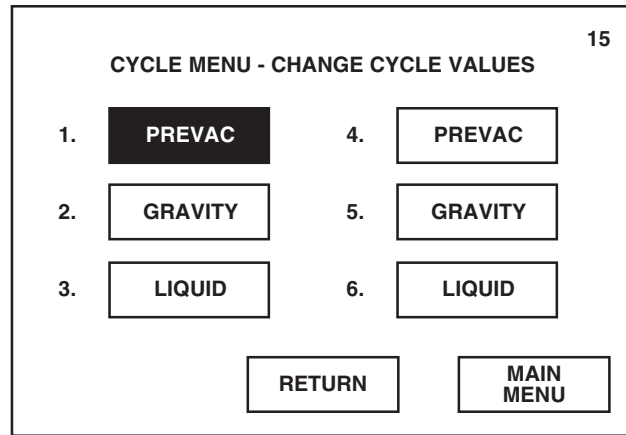

3. Screen #16 allows operator to choose the type of cycle that will be assigned to the selected cycle button. The current cycle name and assigned cycle type are shown at the bottom of the display.

For this example, press **PREVAC** to assign a Prevacuum cycle type.

Pressing CYCLE MENU returns display to screen #15.

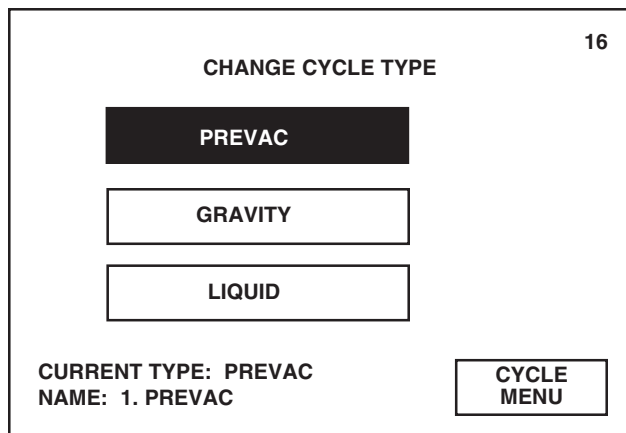

4. Screen #20 is the first of three menu screens which list the programmable values for the Prevacuum cycle type. To change any of the listed cycle values, press the corresponding button.

NOTE: A definition of each cycle value is given on the corresponding display screen.

Pressing **CYCLE MENU** returns display to screen #15.

Pressing **NEXT** advances display to screen #21.

Pressing **MAIN MENU** returns display to screen #1.

20

CHANGE VALUES - 1. PREVAC (PREVAC)

CYCLE NAME = PREVAC
PURGE TIME = 1:00
PULSES = 4
MAX. PRESS. = 26.0 psig
MIN. PRESS. = 10.0 inHg

CYCLE MENU

NEXT

MAIN MENU

Cycle Name
(Cycle Type)

- Pressing **CYCLE NAME** advances display to screen #77. This screen allows operator to enter a custom name for the selected cycle.

Enter customized cycle name, maximum of 8 characters, using the alpha-numeric keypad. Cycle name appears on display as it is being entered.

NOTE: Custom cycle name appears inside the corresponding touch screen button on screens #2 and #15, along top of corresponding in-cycle screens (#9) and on corresponding in-cycle printouts.

Pressing ← or → moves the cursor to the left or right, respectively.

Pressing **RETURN** saves the changed cycle value and returns display to screen #20.

77

CYCLE NAME - PREVAC TYPE

A	B	C	D	E	F	G	H
I	J	K	L	M	N	O	P
Q	R	S	T	U	V	W	X
Y	Z	SPACE			0	1	
2	3	4	5	6	7	8	9

←
→

CYCLE NAME

RETURN

- Pressing **PURGE TIME** advances display to screen #28. Enter purge time using the numeric keypad. Time appears on display as it is being entered.

Pressing ← or → on numeric keypad moves the cursor to the left or right, respectively.

Pressing RETURN saves the changed cycle value and returns display to screen #20.

Definition of Cycle Value

28		
CHANGE VALUES - PURGE TIME		
SET PURGE TIME 01:00		
(Minutes:Seconds)		
1	2	3
4	5	6
7	8	9
←	0	→
<p>The purge time is the amount of time spent in the purge phase.</p>		
<div style="border: 1px solid black; padding: 5px; display: inline-block;">RETURN</div>		

- Pressing **PULSES** advances display to screen #29. Enter number of pulses using the numeric keypad. Number appears on display as it is being entered.

Pressing ← or → on numeric keypad moves the cursor to the left or right, respectively.

Pressing RETURN saves the changed cycle value and returns display to screen #20.

29		
CHANGE VALUES - PULSES		
SET NUMBER OF PULSES 04		
<p>The number of pulses is the total number of vacuum pulses in the cycle.</p>		
1	2	3
4	5	6
7	8	9
←	0	→
<div style="border: 1px solid black; padding: 5px; display: inline-block;">RETURN</div>		

- Pressing **MAX. PRESS.** advances display to screen #31. Enter maximum pressure value using the numeric keypad. Allowable maximum pressure range is 0-45 psig. Pressure value appears on display as it is being entered.

NOTE: If an out-of-range cycle value is entered, a display screen will appear indicating the incorrect value and the allowable range. Display screen will automatically return to previous screen, allowing operator to enter an in-range cycle value.

Pressing ← or → on numeric keypad moves the cursor to the left or right, respectively.

Pressing RETURN saves the changed cycle value and returns display to screen #20.

CHANGE VALUES - MAX. PRESS.		31
SET MAX. PRESS.		
26.0 psig		
The max. press. is the pressure level that the charge pulses will reach.		
1	2	3
4	5	6
7	8	9
←	0	→
RETURN		

- Pressing **MIN. PRESS.** advances display to screen #30. Enter minimum pressure value using the numeric keypad. Allowable minimum pressure range is 0-29.9 inHg. Pressure value appears on display as it is being entered.

NOTE: If an out-of-range cycle value is entered, a display screen will appear indicating the incorrect value and the allowable range. Display screen will automatically return to previous screen, allowing operator to enter an in-range cycle value.

Pressing ← or → on numeric keypad moves the cursor to the left or right, respectively.

Pressing RETURN saves the changed cycle value and returns display to screen #20.

CHANGE VALUES - MIN. PRESS.		30
SET MIN. PRESS.		
10.0 inHg		
The min. press. is the pressure level that the vacuum pulses will reach.		
1	2	3
4	5	6
7	8	9
←	0	→
RETURN		

- Press **NEXT** button on screen #20. Screen #21 is the second of three menu screens which list the programmable values for the Prevacuum cycle type. To change any of the listed cycle values, press the corresponding button.

NOTE: A definition of each cycle value is given on the corresponding display screen.

Pressing PREVIOUS returns display to screen #20.

Pressing NEXT advances display to screen #22.

Pressing MAIN MENU returns display to screen #1.

21

CHANGE VALUES - 1. PREVAC (PREVAC)

STER. TIME = 4:00
STER. TEMP = 132.0 C
OVERDRIVE = 1.5 C
UNDER TEMP = 1.0 C
OVER TEMP = 6.0 C

PREVIOUS

NEXT

MAIN MENU

Cycle Name
(Cycle Type)

- Pressing **STER. TIME** advances display to screen #32. Enter sterilize time using the numeric keypad. Time appears on display as it is being entered.

Pressing ← or → on numeric keypad moves the cursor to the left or right, respectively.

Pressing RETURN saves the changed cycle value and returns display to screen #21.

32

CHANGE VALUES - STER. TIME

SET STER. TIME
00:04:00

(Hours:Minutes:Seconds)

The ster. time is the minimum time spent during the sterilize phase.

The actual sterilize time may become longer because of undertemp or overtemp alarms.

1	2	3
4	5	6
7	8	9
←	0	→

RETURN

- Pressing **STER. TEMP** advances display to screen #33. Enter sterilize temperature using the numeric keypad. Allowable sterilize temperature range is 100°-141°C (212°-285°F) for Prevac and Gravity cycles; 100°-125°C (212°-257°F) for Liquid cycle. Temperature appears on display as it is being entered.

NOTE: If an out-of-range cycle value is entered, a display screen will appear indicating the incorrect value and the allowable range. Display screen will automatically return to previous screen, allowing operator to enter an in-range cycle value.

Pressing ← or → on numeric keypad moves the cursor to the left or right, respectively.

Pressing RETURN saves the changed cycle value and returns display to screen #21.

33		
CHANGE VALUES - STER. TEMP		
SET STER. TEMP		
132.0 C		
The sterilize temp. is the temp. when the sterilize phase will start.		
1	2	3
4	5	6
7	8	9
←	0	→
RETURN		

- Pressing **OVERDRIVE** advances display to screen #34. Enter override temperature using the numeric keypad. Temperature appears on display as it is being entered.

Pressing ← or → on numeric keypad moves the cursor to the left or right, respectively.

Pressing RETURN saves the changed cycle value and returns display to screen #21.

34		
CHANGE VALUES - OVERDRIVE		
SET OVERDRIVE		
0.8 C		
The override plus the sterilize temp. is the control temp. during the sterilize phase.		
1	2	3
4	5	6
7	8	9
←	0	→
RETURN		

- Pressing **UNDER TEMP** advances display to screen #35. Enter under temperature value using the numeric keypad. Temperature appears on display as it is being entered.

If an under temperature alarm occurs, cycle operation will hold until the sterilize temperature recovers. Once minimum temperature is reached, sterilize phase may be programmed to either restart or resume at the time when the alarm is cleared. Current programmed setting is shown in the display screen, as indicated below.

Pressing ← or → on numeric keypad moves the cursor to the left or right, respectively.

Pressing RETURN saves the changed cycle value and returns display to screen #21.

35

CHANGE VALUES - UNDER TEMP

SET UNDER TEMP
1.0 C

The sterilize temp. minus the under temp. is the minimum sterilize temp. before an under temp. alarm occurs.
If the alarm clears, the sterilize time will RESTART.

1	2	3
4	5	6
7	8	9
←	0	→

STERILIZE
TIME RESUME

RETURN

Current Programmed Setting

Pressing STERILIZE TIME RESUME will program control to resume the sterilize phase time once the alarm clears.

- Pressing **OVER TEMP** advances display to screen #36. Enter over temperature value using the numeric keypad. Temperature appears on display as it is being entered.

Pressing ← or → on numeric keypad moves the cursor to the left or right, respectively.

Pressing RETURN saves the changed cycle value and returns display to screen #21.

36

CHANGE VALUES - OVER TEMP

SET OVER TEMP
06.0 C

The over temp. plus the control temp. is the maximum sterilize temp. before an over temp. alarm occurs.
If the alarm clears, the sterilize time will resume.

1	2	3
4	5	6
7	8	9
←	0	→

RETURN

- Press **NEXT** button on screen #21. Screen #22 is the third of three menu screens which list the programmable values for the Prevacuum cycle type. To change any of the listed cycle values, press the corresponding button.

NOTE: A definition of each cycle value is given on the corresponding display screen.

Pressing PREVIOUS returns display to screen #21.

Pressing CYCLE MENU returns display to screen #15.

Pressing MAIN MENU returns display to screen #1.

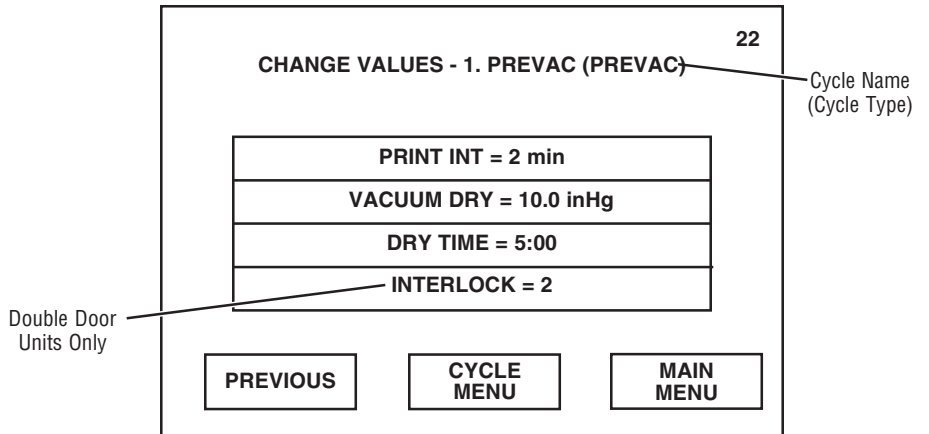

- Pressing **PRINT INT** advances display to screen #118. Enter print interval using the numeric keypad. Minimum print interval is 1 minute. Time appears on display as it is being entered.

Pressing ← or → on numeric keypad moves the cursor to the left or right, respectively.

Pressing RETURN saves the changed cycle value and returns display to screen #22.

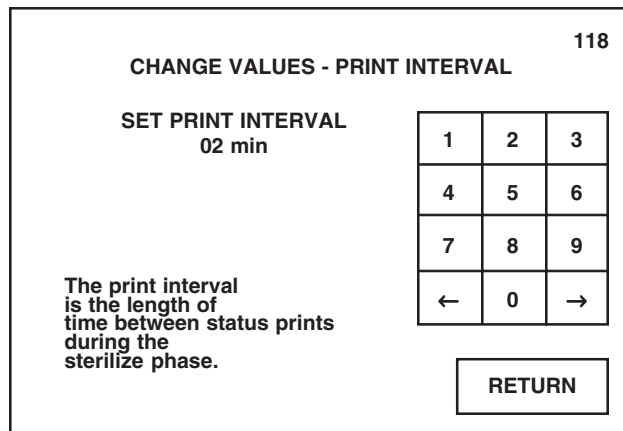

- Pressing **VACUUM DRY** advances display to screen #37. Enter vacuum dry value using the numeric keypad. Allowable vacuum dry range is 0-29.9 inHg. Value appears on the display as it is being entered.

NOTE: If an out-of-range cycle value is entered, a display screen will appear indicating the incorrect value and the allowable range. Display screen will automatically return to previous screen, allowing operator to enter an in-range cycle value.

Pressing ← or → on numeric keypad moves the cursor to the left or right, respectively.

Pressing RETURN saves the changed cycle value and returns display to screen #22.

37		
CHANGE VALUES - VACUUM DRY		
SET VACUUM DRY		
10.0 inHg		
The vacuum dry parameter is the vacuum level when the dry time will start.		
1	2	3
4	5	6
7	8	9
←	0	→
<div style="border: 1px solid black; padding: 5px; display: inline-block; margin-top: 10px;">RETURN</div>		

- Pressing **DRY TIME** advances display to screen #38. Enter dry time using the numeric keypad. Time appears on the display as it is being entered.

Pressing ← or → on numeric keypad moves the cursor to the left or right, respectively.

Pressing RETURN saves the changed cycle value and returns display to screen #22.

38		
CHANGE VALUES - DRY TIME		
SET DRY TIME		
00:05:00		
(Hours:Minutes:Seconds)		
The dry time is the minimum time spent in the dry phase.		
1	2	3
4	5	6
7	8	9
←	0	→
<div style="border: 1px solid black; padding: 5px; display: inline-block; margin-top: 10px;">RETURN</div>		

- If sterilizer is equipped with double doors, pressing **INTERLOCK** advances display to screen #8. Enter interlock type using the numeric keypad. Interlock type appears on the display as it is being entered.

NOTE: Default interlock type is #2. If different setting is desired, a separate interlock type must be set for each cycle.

Pressing ← or → on numeric keypad moves the cursor to the left or right, respectively.

Pressing RETURN saves the changed cycle value and returns display to screen #22.

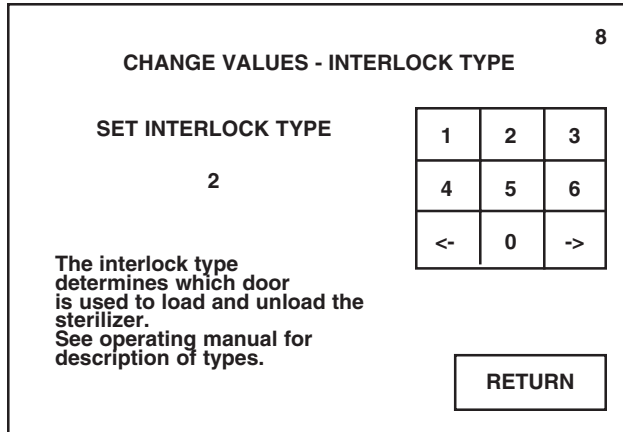

The following descriptions and illustrations explain each interlock type, #0 through #6. Each door on the illustrations is labeled, "A" or "B", for reference. Door A is located on the same end as the main power disconnect switch (see Figure 3-2 for switch location). Door B is located on the opposite end.

#0 = No interlocks. Either door can be used to load and unload the sterilizer. Both doors can be open at the same time. At end of cycle, both doors are automatically unsealed.

#1 = Door A is designated as the operating end (OE). Sterilizer must be loaded from door A, and can be unloaded from door A or door B. At end of cycle, operator must manually unseal the unload door by pressing the **UNSEAL DOOR** touch screen button (screen #65) located on the same end as the door.



NOTE: Once the operating end (OE) door is opened, the non-operating end (NOE) door cannot be opened until a complete cycle is run. If the NOE door is opened, the OE door cannot be opened until the NOE door is closed and sealed.

#2 = Door A is designated as the operating end (OE). Sterilizer must be loaded from door A and unloaded from door B. At end of cycle, door B is automatically unsealed.

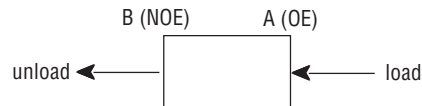

NOTE: Once the operating end (OE) door is opened, the non-operating end (NOE) door cannot be opened until a complete cycle is run. If the NOE door is opened, the OE door cannot be opened until the NOE door is closed and sealed.

#3 = Door B is designated as the operating end (OE). Sterilizer must be loaded from door B, and can be unloaded from door A or door B. At end of cycle, operator must manually unseal the unload door by pressing **UNSEAL DOOR** touch screen button (screen #65) located on the same end as the door.

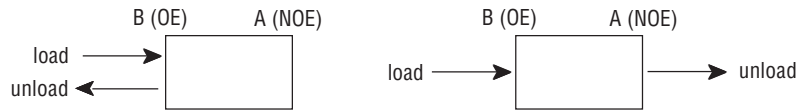

NOTE: Once the operating end (OE) door is opened, the non-operating end (NOE) door cannot be opened until a complete cycle is run. If the NOE door is opened, the OE door cannot be opened until the NOE door is closed and sealed.

#4 = Door B is designated as the operating end (OE). Sterilizer must be loaded from door B and unloaded from door A. At end of cycle, door A is automatically unsealed.

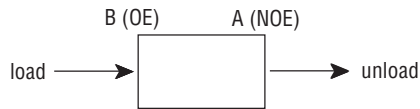

NOTE: Once the operating end (OE) door is opened, the non-operating end (NOE) door cannot be opened until a complete cycle is run. If the NOE door is opened, the OE door cannot be opened until the NOE door is closed and sealed.

#5 = Door A is designated as the operating end (OE) door. Sterilizer must be loaded and unloaded from door A; door B is locked out. At end of cycle, door A is automatically unsealed.

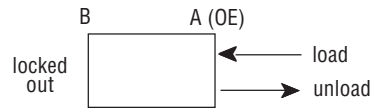

#6 = Door B is designated as the operating end (OE) door. Sterilizer must be loaded and unloaded from door B; door A is locked out. At end of cycle, door B is automatically unsealed.

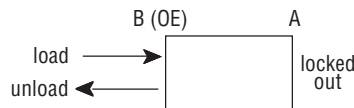

7. After all cycle value changes have been made, press **CYCLE MENU** button on screen #22. Display returns to screen #15.

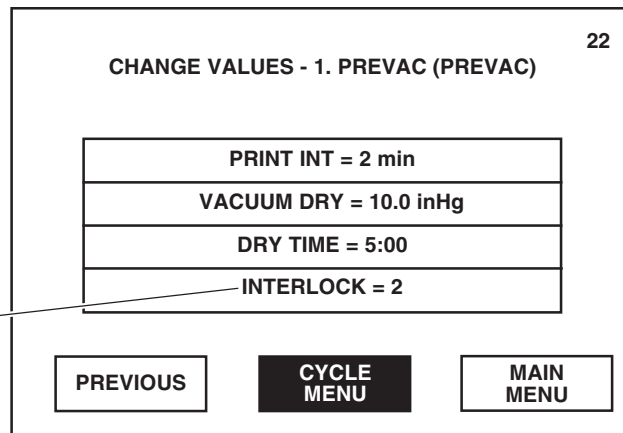

Pressing **PREVIOUS** returns display to screen #21.

Pressing **MAIN MENU** returns display to screen #1.

8. From screen #15, remaining cycles can be modified if necessary. The procedures for changing other cycle values are similar to the Change Values procedure just outlined.

Once all changes to the cycles and cycle values are completed, press **RETURN**. Display returns to screen #14.

Pressing MAIN MENU returns display to screen #1.

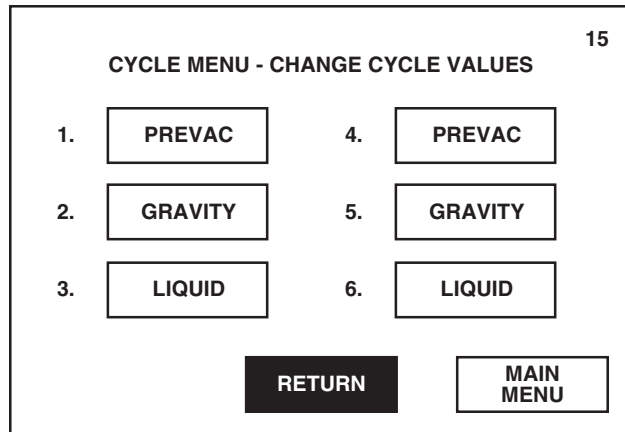

9. From screen #14, the sterilizer operating parameters (i.e., Too Long In Phase, Time/Date and Setup) can be changed. Refer to Section 8, Programming Operating Parameters, for details.

After all changes are completed, press **RETURN** button. Control exits the Change Values option, saving all changes made, and display returns to screen #13.

Pressing MAIN MENU returns display to screen #1.

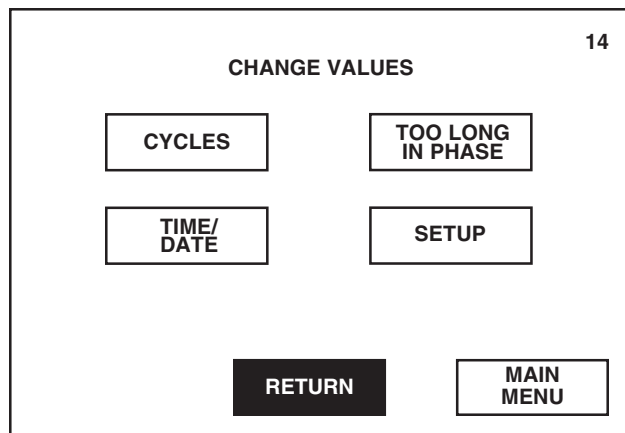

10. Refer to *SECTION 10, OUT OF CYCLE OPTIONS*, for information on the other options listed on screen #13.

Press **MAIN MENU** to return display to main menu (screen #1).

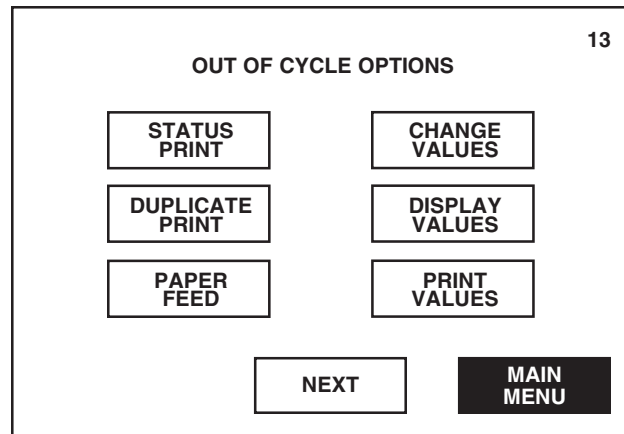

The Amsco® Century Medium Steam Sterilizer 26 x 26" (660 x 660 mm) is factory programmed with default cycle values and operating parameters. The operating parameters are used to control the general way a sterilizer operates. Sterilizer operating parameters include time/date, too long in phase values and setup values.

NOTE: Control will default to the factory-programmed values if a battery or battery-powered memory failure occurs.

This section outlines how to change the operating parameters only. For details on modifying the default cycle values, refer to *SECTION 8, PROGRAMMING CYCLE VALUES*.

9.1 Access Change Values Menu

To modify the preset sterilizer operating parameters, access the Change Values menu (screen #14) as follows:

1. Press **OPTIONS** on screen #1.

Pressing *CYCLE SELECT* advances display to the first Cycle Select menu (screen #2).

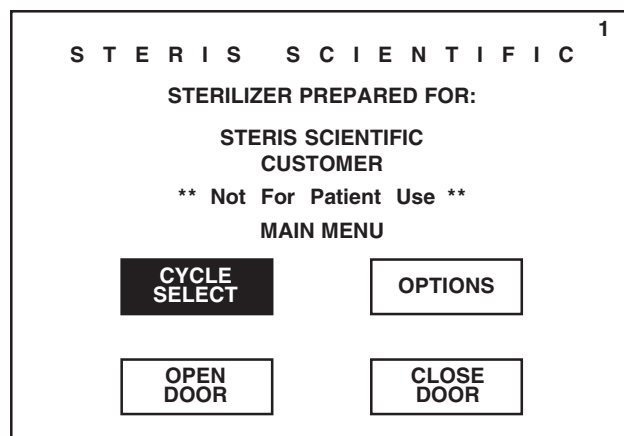

2. Press **CHANGE VALUES**. Printer records the date and time when Change Values option was selected.

Pressing *NEXT* advances display to screen #87.

Pressing *MAIN MENU* returns display to screen #1.

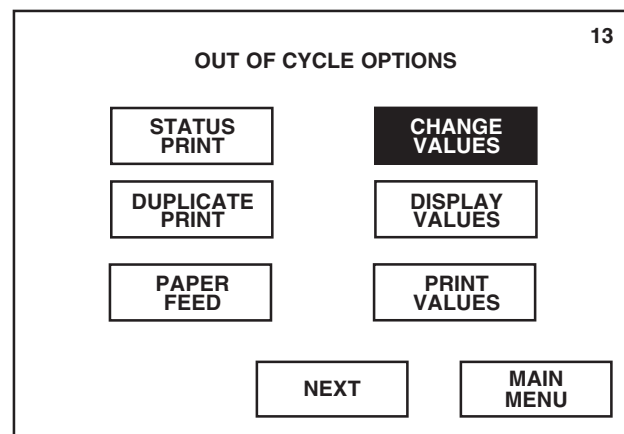

NOTE: If access code feature is activated, an assigned four-digit code must be correctly entered before operator can change parameters. Refer to *SECTION 7, ENTERING ACCESS CODE*.

3. Screen #14 allows operator the selection of either changing the cycle values or changing the sterilizer operating parameters.
 - To change cycle values (CYCLES), refer to *SECTION 8, PROGRAMMING CYCLE VALUES*.
 - To change a specific operating parameter (TOO LONG IN PHASE, TIME/DATE or SETUP), refer to the description, included in this section, titled the same as the button on screen #14.

Pressing RETURN returns display to screen #13.

Pressing MAIN MENU returns display to screen #1.

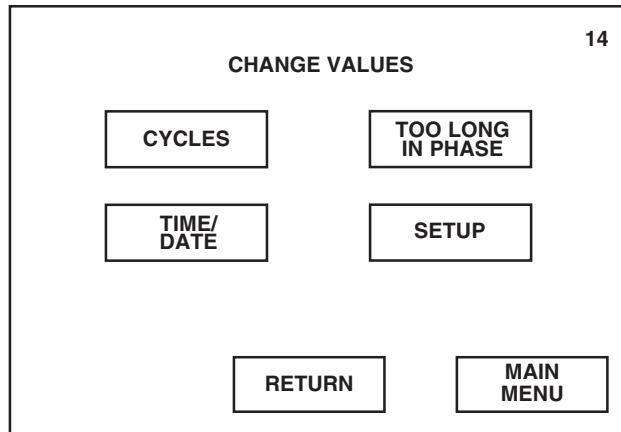

4. To exit Change Values option, press RETURN on screen #14. Control saves all changes made and display returns to screen #13.

9.2 Time/Date

Sterilizer uses the programmed time and date for all printout messages. To adjust time and date:

1. Access Change Values menu (screen #14) as described at the beginning of this section.
2. Press **TIME/DATE**.

Pressing RETURN returns display to screen #13.

Pressing MAIN MENU returns display to screen #1.

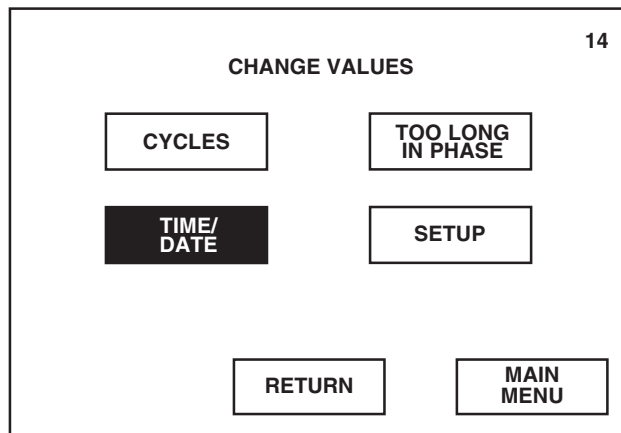

- Press **TIME** button. Enter time using the numeric keypad. Time appears on display as it is being entered. Once time is entered, press AM, PM or MIL to correctly identify the time.

Pressing ← or → on numeric keypad moves the cursor to the left or right, respectively.

Pressing RETURN saves the changed parameter and returns display to screen #14.

Pressing MAIN MENU returns display to screen #1.

SET TIME AND DATE		39	
TIME = 00:00 AM Hr Mn	AM	PM	MIL
	1	2	3
	4	5	6
	7	8	9
	←	0	→
<div style="border: 1px solid black; padding: 5px; display: inline-block;">RETURN</div>	<div style="border: 1px solid black; padding: 5px; display: inline-block;">MAIN MENU</div>		

- Press **DATE** button. Enter date using the numeric keypad. Date appears on display as it is being entered.

Pressing ← or → on numeric keypad moves the cursor to the left or right, respectively.

Pressing RETURN saves the changed parameter and returns display to screen #14.

Pressing MAIN MENU returns display to screen #1.

SET TIME AND DATE		39	
TIME = 00:00 AM Hr Mn	AM	PM	MIL
	1	2	3
	4	5	6
	7	8	9
	←	0	→
<div style="border: 1px solid black; padding: 5px; display: inline-block;">DATE = 00/00/00</div> Mo Da Yr	<div style="border: 1px solid black; padding: 5px; display: inline-block;">RETURN</div>		
	<div style="border: 1px solid black; padding: 5px; display: inline-block;">MAIN MENU</div>		

- Once correct time and date have been entered, press **RETURN** on screen #39. Control saves all changes made, printer records the time and date programmed and display returns to screen #14.

9.3 Too Long In Phase

Sterilizer uses the "too long in phase" values to monitor and control the length of the associated cycle phases. Each "too long in phase" value is factory programmed at 30 minutes.

To adjust the "too long in phase" values:

1. Access Change Values menu (screen #14) as described at the beginning of this section.
2. Press **TOO LONG IN PHASE**.

Pressing RETURN returns display to screen #13.

Pressing MAIN MENU returns display to screen #1.

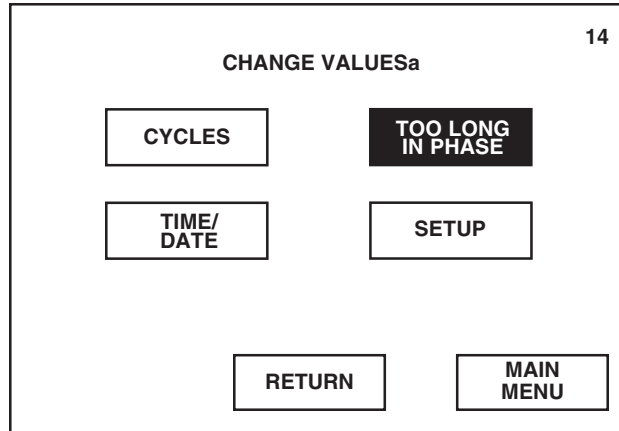

3. Screen #40 is the first of two menu screens which list the phase and its currently set value. To change any of the listed values (parameters), press the corresponding button.

NOTE: A definition of each value (parameter) is given on the corresponding display screen.

Pressing RETURN saves all changed parameters and returns display to screen #14.

Pressing NEXT advances display to screen #53.

Pressing MAIN MENU returns display to screen #1.

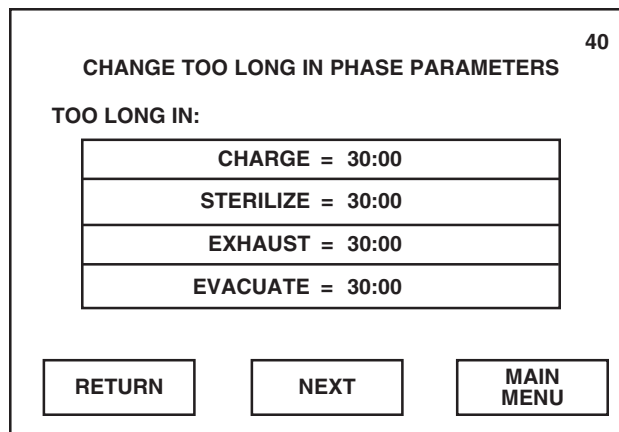

- Pressing **CHARGE** advances display to screen #41. Enter charge phase value using the numeric keypad. Value appears on display as it is being entered.

Pressing ← or → on numeric keypad moves the cursor to the left or right, respectively.

Pressing RETURN saves the changed parameter and returns display to screen #40.

Definition of Parameter

41

CHANGE VALUES - TOO LONG IN CHARGE

SET TOO LONG IN CHARGE
30:00

(Minutes:Seconds)

1	2	3
4	5	6
7	8	9
←	0	→

RETURN

The too long in charge is the allowable amount of time that the chamber has to reach the set point during charge pulse or charge phase before an alarm occurs.

- Pressing **STERILIZE** advances display to screen #52. Enter sterilize phase value using the numeric keypad. Value appears on display as it is being entered.

Pressing ← or → on numeric keypad moves the cursor to the left or right, respectively.

Pressing RETURN saves the changed parameter and returns display to screen #40.

52

CHANGE VALUES - TOO LONG IN STERILIZE

SET TOO LONG IN STERILIZE
30:00

(Minutes:Seconds)

1	2	3
4	5	6
7	8	9
←	0	→

RETURN

The too long in sterilize is the allowable amount of time that the sterilize phase may go beyond the set sterilize time. The cycle will then abort.

- Pressing **EXHAUST** advances display to screen #42. Enter exhaust phase value using the numeric keypad. Value appears on display as it is being entered.

Pressing ← or → on numeric keypad moves the cursor to the left or right, respectively.

Pressing RETURN saves the changed parameter and returns display to screen #40.

42

CHANGE VALUES - TOO LONG IN EXHAUST

SET TOO LONG IN EXHAUST
30:00

(Minutes:Seconds)

1	2	3
4	5	6
7	8	9
←	0	→

RETURN

The too long in exhaust is the allowable amount of time that the chamber has to reach 4 psig before an alarm occurs.

- Pressing **EVACUATE** advances display to screen #43. Enter evacuate phase value using the numeric keypad. Value appears on display as it is being entered.

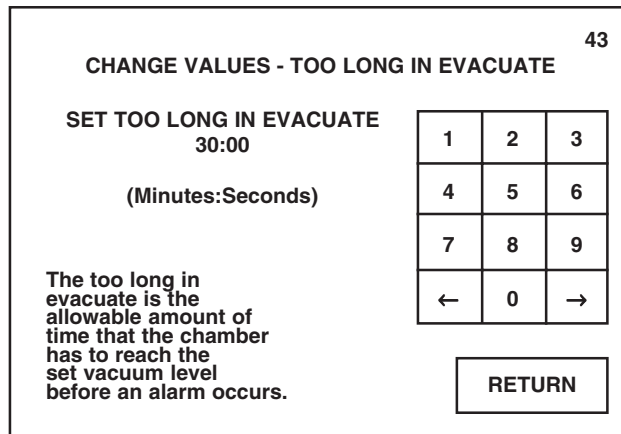

Pressing ← or → on numeric keypad moves the cursor to the left or right, respectively.

Pressing RETURN saves the changed parameter and returns display to screen #40.

- Press **NEXT** button on screen #40. Screen #53 is the second of two menu screens which list the phase and its currently set value. To change any of the listed values, press the corresponding button.

NOTE: A definition of each value (parameter) is given on the corresponding display screen.

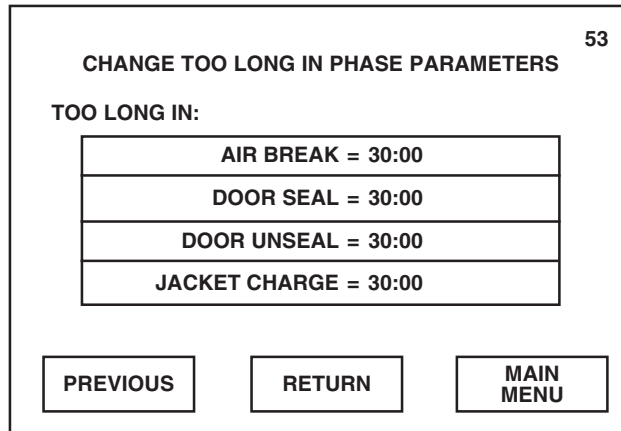

Pressing PREVIOUS returns display to screen #40.

Pressing RETURN saves all changed parameters and returns display to screen #14.

Pressing MAIN MENU returns display to screen #1.

- Pressing **AIR BREAK** advances display to screen #44. Enter air break phase value using the numeric keypad. Value appears on display as it is being entered.

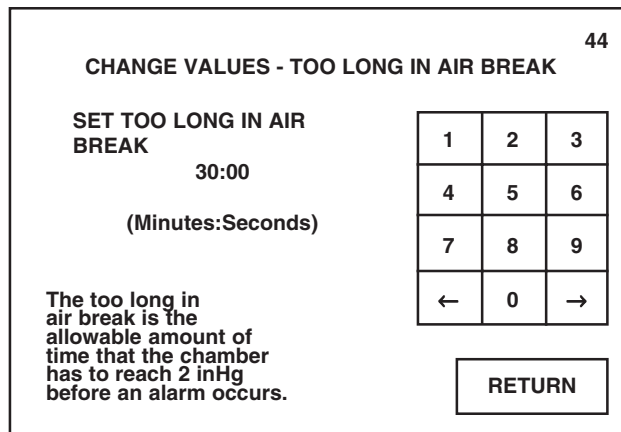

Pressing ← or → on numeric keypad moves the cursor to the left or right, respectively.

Pressing RETURN saves the changed parameter and returns display to screen #53.

- Pressing **DOOR SEAL** advances display to screen #54. Enter door seal phase value using the numeric keypad. Value appears on display as it is being entered.

Pressing ← or → on numeric keypad moves the cursor to the left or right, respectively.

Pressing RETURN saves the changed parameter and returns display to screen #53.

54		
CHANGE VALUES - TOO LONG IN DOOR SEAL		
SET TOO LONG IN DOOR SEAL 30:00 (Minutes:Seconds)		
1	2	3
4	5	6
7	8	9
←	0	→
The too long in door seal is the allowable amount of time that the door has to seal before an alarm occurs.		
<div style="border: 1px solid black; padding: 5px; display: inline-block;">RETURN</div>		

- Pressing **DOOR UNSEAL** advances display to screen #55. Enter door unseal phase value using the numeric keypad. Value appears on display as it is being entered.

Pressing ← or → on numeric keypad moves the cursor to the left or right, respectively.

Pressing RETURN saves the changed parameter and returns display to screen #53.

55		
CHANGE VALUES - TOO LONG IN DOOR UNSEAL		
SET TOO LONG IN DOOR UNSEAL 30:00 (Minutes:Seconds)		
1	2	3
4	5	6
7	8	9
←	0	→
The too long in door unseal is the allowable amount of time that the door has to unseal before an alarm occurs.		
<div style="border: 1px solid black; padding: 5px; display: inline-block;">RETURN</div>		

- Pressing **JACKET CHARGE** advances display to screen #59. Enter jacket charge phase value using the numeric keypad. Value appears on display as it is being entered.

Pressing ← or → on numeric keypad moves the cursor to the left or right, respectively.

Pressing RETURN saves the changed parameter and returns display to screen #53.

59		
CHANGE VALUES - TOO LONG IN JACKET CHARGE		
SET TOO LONG IN JACKET CHARGE 30:00 (Minutes:Seconds)		
1	2	3
4	5	6
7	8	9
←	0	→
The too long in jacket charge is the allowable amount of time that the jacket has to charge to the set point before an alarm occurs.		
<div style="border: 1px solid black; padding: 5px; display: inline-block;">RETURN</div>		

- Once the correct "too long in phase" values have been entered, press **RETURN** on screen #53. Control saves all changes made and display returns to screen #14.

Pressing **PREVIOUS** returns display to screen #40.

Pressing **MAIN MENU** returns display to screen #1.

CHANGE TOO LONG IN PHASE PARAMETERS		53
TOO LONG IN:		
AIR BREAK = 30:00		
DOOR SEAL = 30:00		
DOOR UNSEAL = 30:00		
JACKET CHARGE = 30:00		
PREVIOUS	RETURN	MAIN MENU

9.4 Setup

Sterilizer uses the setup options to assign the temperature and pressure units, control volume of audible signals, control utilities sterilizer shutdown feature and control printer functions.

- Access Change Values menu (screen #14) as described at the beginning of this section.
- Press **SETUP**.

Pressing **RETURN** returns display to screen #13.

Pressing **MAIN MENU** returns display to screen #1.

CHANGE VALUES		14
CYCLES	TOO LONG IN PHASE	
TIME/ DATE	SETUP	
RETURN	MAIN MENU	

- Screen #50 lists six setup options. To change a specific setup option, refer to the following description titled the same as the button on screen #50.

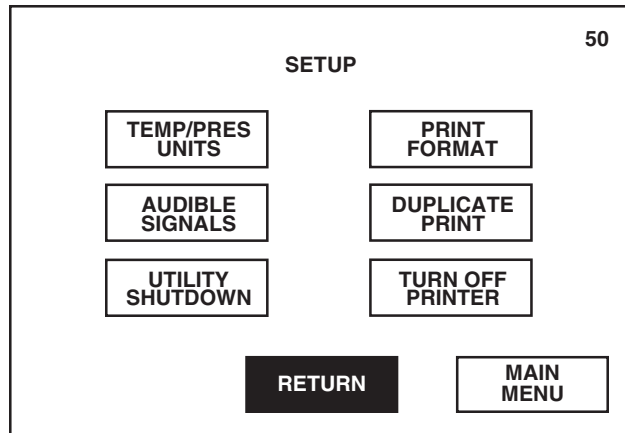

Pressing RETURN saves all changed setup values and returns display to screen #14.

Pressing MAIN MENU returns display to screen #1.

- To exit Setup option, press **RETURN** on screen #50. Control saves all changes made and display returns to Change Values menu (screen #14).

9.4.1 Temp/Pres Units

This setup option allows operator to select the temperature and pressure units that the control will use for all display and printout messages. Default pressure unit is psig/inHg; default temperature unit is degrees Celsius (°C).

- Press **TEMP/PRES UNITS** on screen #50.

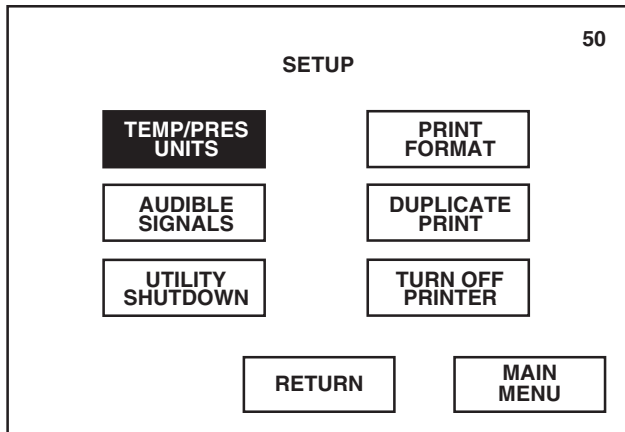

Pressing RETURN returns display to screen #14.

Pressing MAIN MENU returns display to screen #1.

- To change the programmed pressure unit, press **PRESSURE** button.

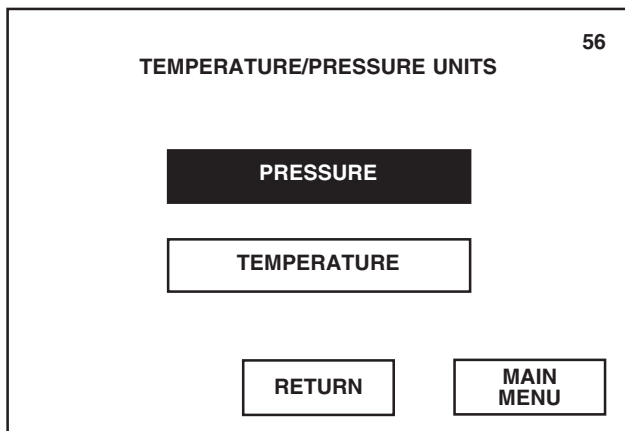

Pressing RETURN returns display to screen #50.

Pressing MAIN MENU returns display to screen #1.

3. Select the desired pressure unit by pressing the appropriate button. Current unit setting appears under the screen title.

Display automatically returns to screen #56 once a pressure unit is selected.

NOTE: Recalibration is not required if pressure unit is changed.

Pressing CANCEL returns display to screen #56 without changing the current setting.

Pressing MAIN MENU returns display to screen #1.

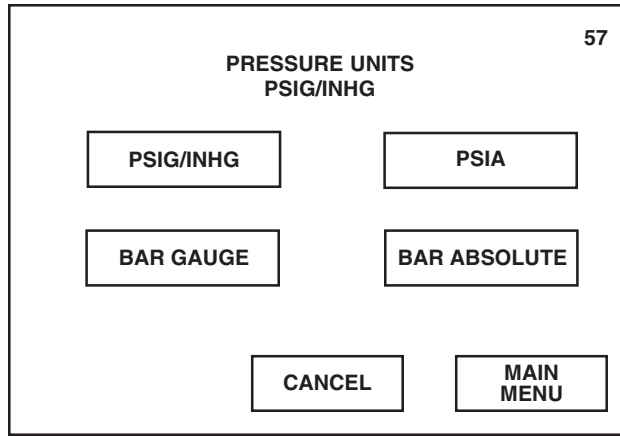

4. To change the programmed temperature unit, press **TEMPERATURE** button.

Pressing RETURN returns display to screen #50.

Pressing MAIN MENU returns display to screen #1.

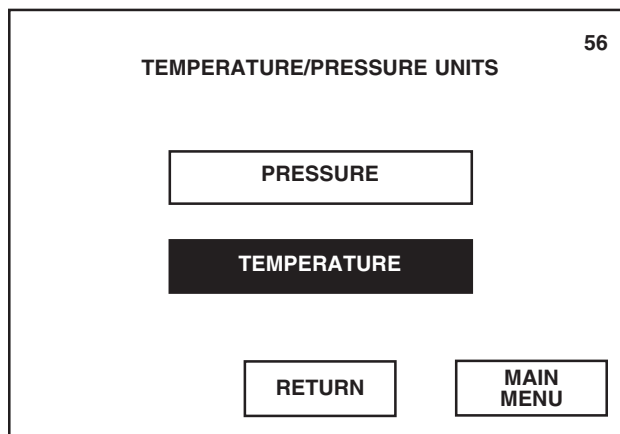

5. Select the desired temperature unit by pressing the appropriate button. Current unit setting appears under the screen title.

Display automatically returns to screen #56 once a temperature unit is selected.

NOTE: Recalibration is not required if temperature unit is changed.

Pressing CANCEL returns display to screen #56 without changing the current setting.

Pressing MAIN MENU returns display to screen #1.

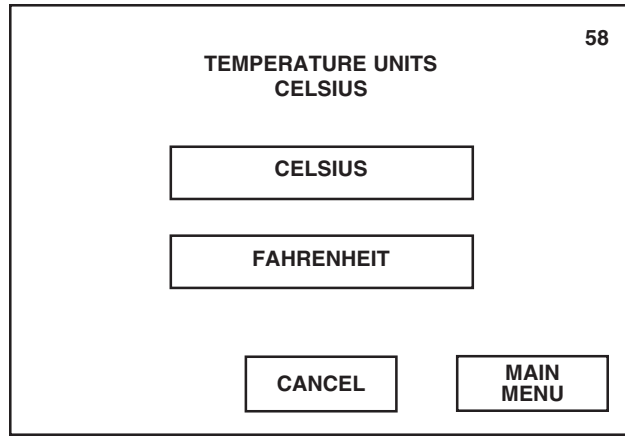

6. Once pressure and temperature units have been selected, press **RETURN** on screen #56. Control saves all changes made and display returns to screen #50.

Pressing MAIN MENU returns display to screen #1.

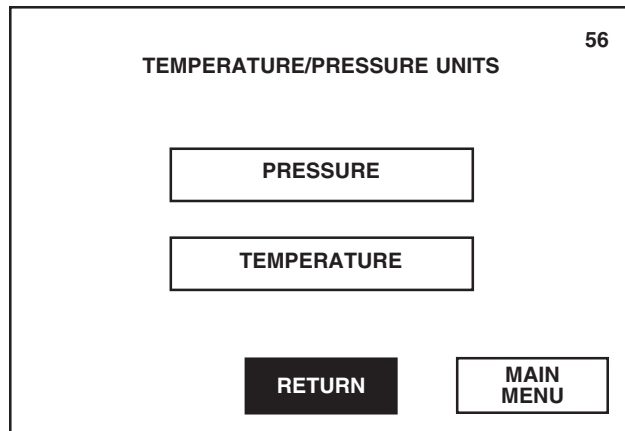

9.4.2 Audible Signals

This setup option allows adjustment of the audible signal tones sounded by the control. Three signals can be adjusted and each signal can be independently adjusted to one of three volume levels or turned off.

1. Press **AUDIBLE SIGNALS** on screen #50.

Pressing RETURN returns display to screen #14.

Pressing MAIN MENU returns display to screen #1.

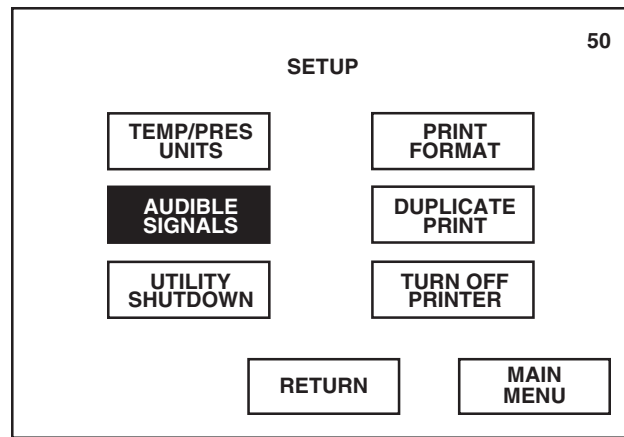

2. Select the signal to be changed by pressing the appropriate button.

- **ALARM** – tone sounded during abnormal (alarm) conditions.
- **END OF CYCLE** – tone sounded when cycle operation is complete.
- **TOUCHPAD** – tone sounded whenever a touch screen button is pressed.

Pressing RETURN saves all changed settings and returns display to screen #50.

Pressing MAIN MENU returns display to screen #1.

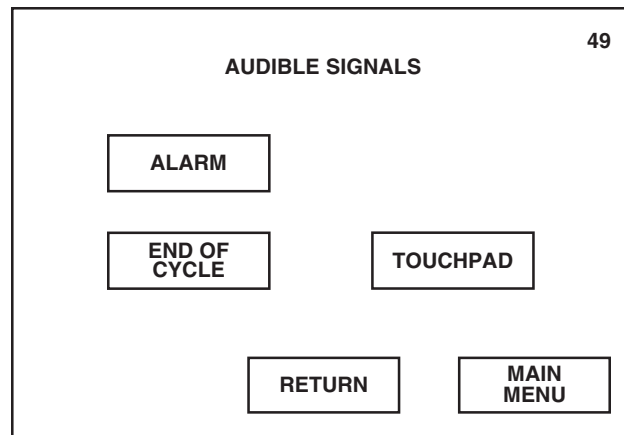

- To stop the signal tone from sounding, press **OFF**. To select the desired volume level, press the corresponding button (**LOW**, **MEDIUM** or **HIGH**). Current volume setting appears under the screen title.

NOTE: Alarm signal tone cannot be turned off.

Once signal tone is selected, press **RETURN** to return display to screen #49.

Pressing MAIN MENU returns display to screen #1.

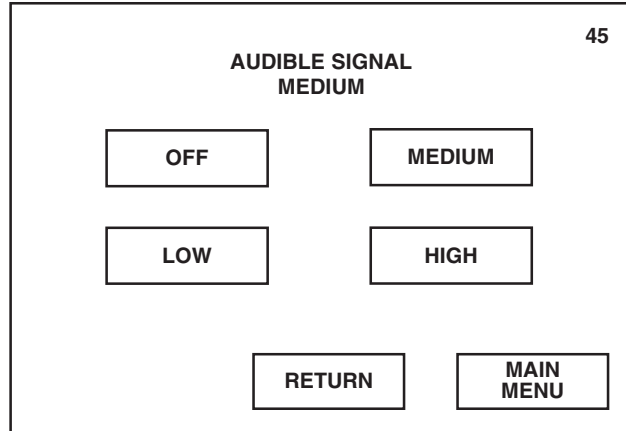

- Once all signals have been adjusted, press **RETURN** on screen #49. Control saves all changes made and display returns to screen #50.

Pressing MAIN MENU returns display to screen #1.

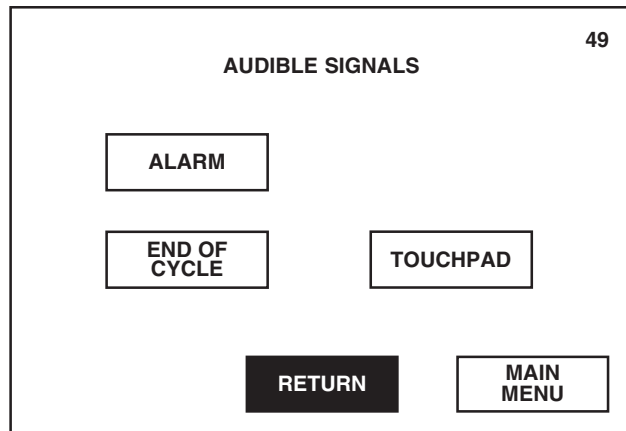

9.4.3 Utility Shutdown

Utility shutdown feature is used to automatically control the utility services to the sterilizer. The sterilizer can be programmed to automatically shut off and restart its steam and water supplies at any time during the day, conserving utilities.

1. Press **UTILITY SHUTDOWN** on screen #50.

Pressing RETURN returns display to screen #14.

Pressing MAIN MENU returns display to screen #1.

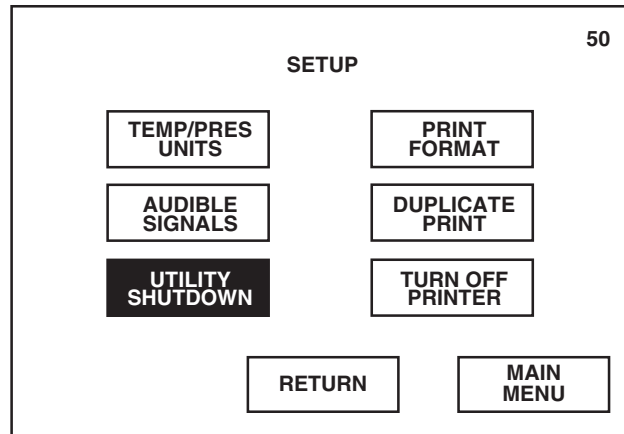

2. Press **YES** to select the utility shutdown option.

Pressing NO refuses the utility shutdown option and returns display to screen #50.

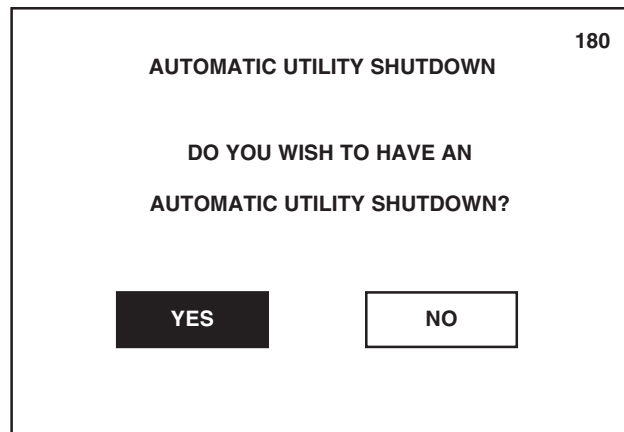

3. Screen #181 allows operator to select when the utility shutdown period will occur. To program a utility shutdown period, refer to the following description titled the same as the button on screen #181.

Pressing RETURN saves the changed values and returns display to screen #50.

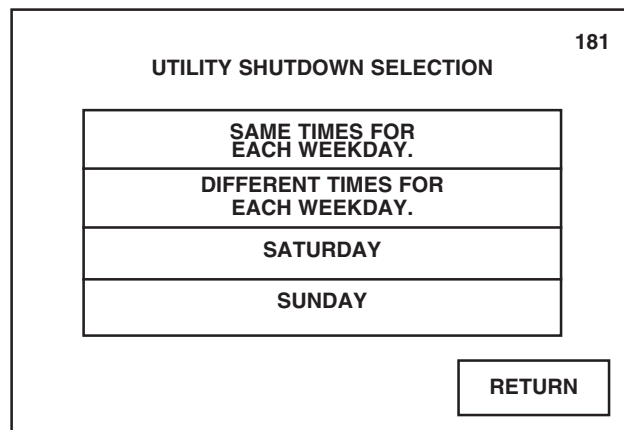

- Once all utility shutdown periods are entered, press RETURN on screen #181. Control saves all changes made and display returns to screen #50.

Same Times For Each Weekday (Monday - Friday)

- Press **SAME TIMES FOR EACH WEEKDAY** on screen #181.

Pressing RETURN returns display to screen #50.

181

UTILITY SHUTDOWN SELECTION

SAME TIMES FOR EACH WEEKDAY.
DIFFERENT TIMES FOR EACH WEEKDAY.
SATURDAY
SUNDAY

RETURN

- Press **SHUTDOWN TIME** button. Enter shutdown time using the numeric keypad. Time appears on display as it is being entered. Once time is entered, press AM, PM or MIL to correctly identify the time.

NOTE: If the sterilizer is running a cycle when the programmed utility shutdown time occurs, the sterilizer completes the cycle before shutting off its utilities. The sterilizer can be manually restarted at any time during the utility shutdown period by pressing the HEXAWAVE on screen #0.

Pressing ← or → on numeric keypad moves the cursor to the left or right, respectively.

Pressing RETURN saves the changed value and returns display to screen #181.

182

SET SHUTDOWN/RESTART TIMES

SHUTDOWN TIME 00:00:00 PM	AM	PM	MIL
	1	2	3
	4	5	6
	7	8	9
	←	0	→

RESTART TIME
00:00:00 AM

RETURN

3. Press **RESTART TIME** button. Enter restart time using the numeric keypad. Time appears on display as it is being entered. Once time is entered, press AM, PM or MIL to correctly identify the time.

Pressing ← or → on numeric keypad moves the cursor to the left or right, respectively.

Pressing RETURN saves the changed value and returns display to screen #181.

SET SHUTDOWN/RESTART TIMES 182

SHUTDOWN TIME
00:00:00 PM

RESTART TIME
00:00:00 AM

AM	PM	MIL
1	2	3
4	5	6
7	8	9
←	0	→

RETURN

4. Once correct times are entered, press **RETURN** on screen #182. Control saves the changed values and display returns to screen #181.

Different Times For Each Weekday (Monday - Friday)

1. Press **DIFFERENT TIMES FOR EACH WEEKDAY** on screen #181.

Pressing RETURN returns display to screen #50.

UTILITY SHUTDOWN SELECTION 181

SAME TIMES FOR EACH WEEKDAY.

DIFFERENT TIMES FOR EACH WEEKDAY.

SATURDAY

SUNDAY

RETURN

2. Screen #184 allows operator to program a different shutdown period for each week day listed. Press the **week day** button corresponding with the day to be changed.

Pressing RETURN returns display to screen #181.

184

WEEKDAY UTILITY SHUTDOWN TIMES

MONDAY

TUESDAY

WEDNESDAY

THURSDAY

FRIDAY

RETURN

3. Press **SHUTDOWN TIME** button. Enter shutdown time using the numeric keypad. Time appears on display as it is being entered. Once time is entered, press AM, PM or MIL to correctly identify the time.

*NOTE: If the sterilizer is running a cycle when the programmed utility shutdown time occurs, the sterilizer completes the cycle before shutting off its utilities. The sterilizer can be manually restarted at any time during the utility shutdown period by pressing **HEXAWAVE** on screen #0.*

Pressing ← or → on numeric keypad moves the cursor to the left or right, respectively.

Pressing RETURN saves the changed value and returns display to screen #184.

182

SET SHUTDOWN/RESTART TIMES

SHUTDOWN TIME
00:00:00 PM

RESTART TIME
00:00:00 AM

AM	PM	MIL
1	2	3
4	5	6
7	8	9
←	0	→

RETURN

- Press **RESTART TIME** button. Enter restart time using the numeric keypad. Time appears on display as it is being entered. Once time is entered, press **AM**, **PM** or **MIL** to correctly identify the time.

Pressing ← or → on numeric keypad moves the cursor to the left or right, respectively.

Pressing RETURN saves the changed value and returns display to screen #184.

SET SHUTDOWN/RESTART TIMES
182

SHUTDOWN TIME
00:00:00 PM

AM	PM	MIL
1	2	3
4	5	6
7	8	9
←	0	→

RESTART TIME
00:00:00 AM

RETURN

- Once correct times are entered for the selected week day, press **RETURN** on screen #182. Control saves the changed values and returns display to screen #184, allowing operator to program times for another week day.
- Once shutdown periods are entered for each week day, press **RETURN** on screen #184. Display returns to screen #181.

Pressing RETURN returns display to screen #181.

WEEKDAY UTILITY SHUTDOWN TIMES
184

MONDAY

THURSDAY

TUESDAY

FRIDAY

WEDNESDAY

RETURN

Saturday or Sunday

1. Press **SATURDAY** or **SUNDAY** on screen #181.

Pressing **RETURN** returns display to screen #50.

181

UTILITY SHUTDOWN SELECTION

SAME TIMES FOR EACH WEEKDAY.
DIFFERENT TIMES FOR EACH WEEKDAY.
SATURDAY
SUNDAY

RETURN

2. Press **SHUTDOWN TIME** button. Enter shutdown time using the numeric keypad. Time appears on display as it is being entered. Once time is entered, press AM, PM or MIL to correctly identify the time.

*NOTE: If the sterilizer is running a cycle when the programmed utility shutdown time occurs, the sterilizer completes the cycle before shutting off its utilities. The sterilizer can be manually restarted at any time during the utility shutdown period by pressing **CANCEL SHUTDOWN** on screen #183.*

Pressing ← or → on numeric keypad moves the cursor to the left or right, respectively.

Pressing **RETURN** saves the changed value and returns display to screen #184.

182

SET SHUTDOWN/RESTART TIMES

SHUTDOWN TIME 00:00:00 PM	AM	PM	MIL
	1	2	3
	4	5	6
	7	8	9
	←	0	→

RESTART TIME
00:00:00 AM

RETURN

3. Press **RESTART TIME** button. Enter restart time using the numeric keypad. Time appears on display as it is being entered. Once time is entered, press AM, PM or MIL to correctly identify the time.

Pressing ← or → on numeric keypad moves the cursor to the left or right, respectively.

Pressing RETURN saves the changed value and returns display to screen #184.

SET SHUTDOWN/RESTART TIMES		182															
SHUTDOWN TIME 00:00:00 PM		<table border="1" style="width: 100%; border-collapse: collapse; text-align: center;"> <thead> <tr> <th style="width: 33%;">AM</th> <th style="width: 33%;">PM</th> <th style="width: 33%;">MIL</th> </tr> </thead> <tbody> <tr> <td>1</td> <td>2</td> <td>3</td> </tr> <tr> <td>4</td> <td>5</td> <td>6</td> </tr> <tr> <td>7</td> <td>8</td> <td>9</td> </tr> <tr> <td>←</td> <td>0</td> <td>→</td> </tr> </tbody> </table>	AM	PM	MIL	1	2	3	4	5	6	7	8	9	←	0	→
AM	PM	MIL															
1	2	3															
4	5	6															
7	8	9															
←	0	→															
RESTART TIME 00:00:00 AM																	
		RETURN															

4. Once correct times are entered, press **RETURN** on screen #182. Control saves the changed values and display returns to screen #181.

9.4.5 Print Format

This setup option allows selection of the format in which the cycle data will be printed during cycle operation.

1. Press **PRINT FORMAT** on screen #50.

Pressing RETURN returns display to screen #14.

Pressing MAIN MENU returns display to screen #1.

SETUP		50
TEMP/PRES UNITS		PRINT FORMAT
AUDIBLE SIGNALS		DUPLICATE PRINT
UTILITY SHUTDOWN		TURN OFF PRINTER
	RETURN	MAIN MENU

2. Select desired print format by pressing the appropriate button. Current format setting appears under the screen title.

Pressing **RETURN** saves the changed setting and returns display to screen #50.

Pressing **MAIN MENU** returns display to screen #1.

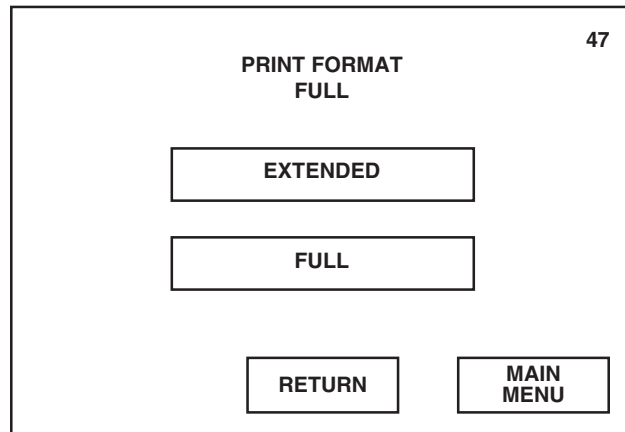

PURGE	
Time of Day	11:48:24A
Chamber Press	0.3 psig
Chamber Temp	66.7 C
STERILIZE	
Time of Day	11:49:43A
Chamber Press	16.6 psig
Chamber Temp	121.2 C

Figure 9-1. Example of Extended Print Format

-	TIME	T=C	V=inHg P=psig
C	11:48:24A	66.7	0.3V
C	11:49:24A	112.7	10.0P
S	11:49:43A	121.2	16.6P
S	11:51:43A	122.6	17.7P
S	11:53:43A	123.3	17.8P
S	11:55:43A	122.6	16.7P

Figure 9-2. Example of Full Print Format

- Pressing **EXTENDED** provides an expanded printout, listing phase name, time, chamber pressure and chamber temperature in an easy-to-read format (see Figure 9-1). Printout is generated at each transition point during the cycle and at set interval points during the sterilize phase.

NOTE: Interval points are determined by the Print Interval, programmed for each cycle. Refer to SECTION 8, PROGRAMMING CYCLE VALUES, for programming the Print Interval.

- Pressing **FULL** provides a one-line printout, listing phase code, time, chamber temperature and chamber pressure in an abbreviated format (see Figure 9-2). Printout is generated at each transition point during the cycle and at set interval points during the sterilize phase. This abbreviated version of the cycle printout reduces paper usage.

3. Once print format is selected, press **RETURN** on screen #47. Control saves the changed value and display returns to screen #50.

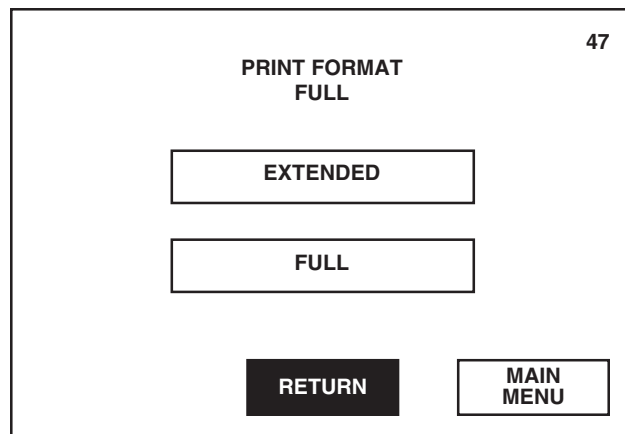

9.4.6 Duplicate Print

The Duplicate Print feature is used to automatically furnish an additional printout at the end of each cycle.

1. Press **DUPLICATE PRINT** on screen #50.

Pressing RETURN returns display to screen #14.

Pressing MAIN MENU returns display to screen #1.

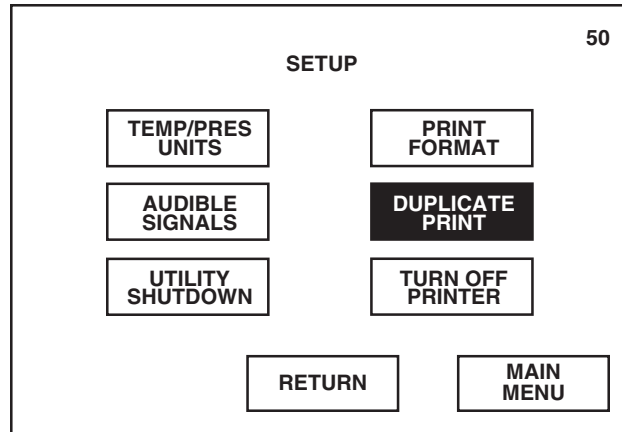

2. Press **YES** to automatically generate a complete duplicate printout on completion of each cycle. The duplicate printout provides the cycle data in the same format as the in-cycle printout. First line of the additional printout will always read "- DUPLICATE PRINT-".

Display automatically returns to screen #50 once a selection is made.

Pressing NO refuses the duplicate printout option and returns display to screen #50. Printer will still generate an in-cycle printout as programmed.

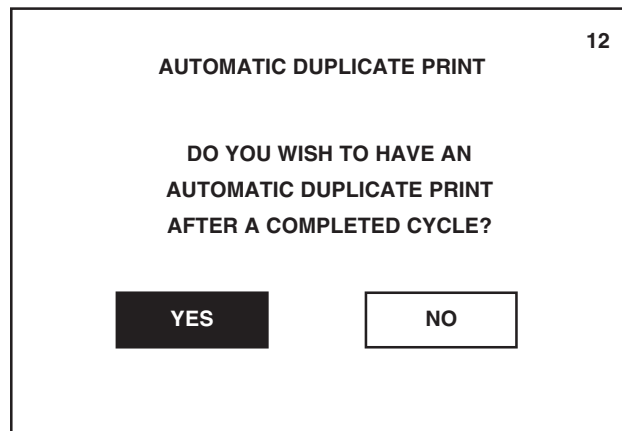

9.4.7 Turn Off Printer

This setup option is used to turn off all printer operations.

Press **TURN OFF PRINTER** on screen #50 to turn off all automatic and manual printer operations. Printer records the time and date when Turn Off Printer was selected.

Printer must be turned on in order to operate any printer functions.

NOTE: Printer should be turned on if cycle records are necessary.

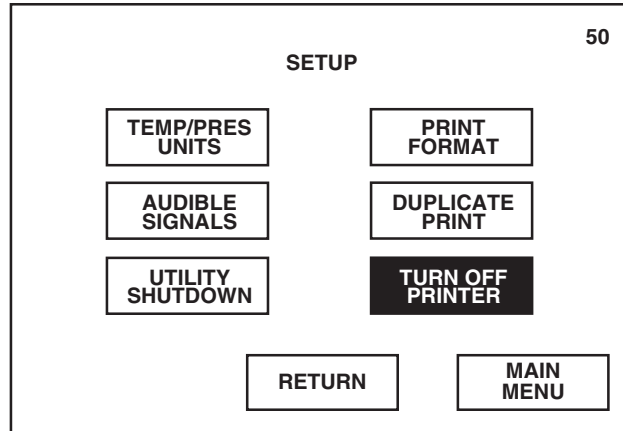

Pressing RETURN saves the changed setup value and returns display to screen #14.

Pressing MAIN MENU returns display to screen #1.

NOTE: If printer is currently turned off, the touch screen button will read TURN ON PRINTER. Pressing this button will turn on the printer and record the time and date when Turn On Printer was selected.

Life Sciences

This section describes each out-of-cycle function accessible from the Out of Cycle Option menu screens.

10.1 General

As previously discussed in *SECTION 5, CONTROL INTERFACE*, pressing **OPTIONS** on screen #1 advances display to the first of two Out of Cycle Options menu screens.

*Pressing **CYCLE SELECT** advances display to the first Cycle Select menu (screen #2).*

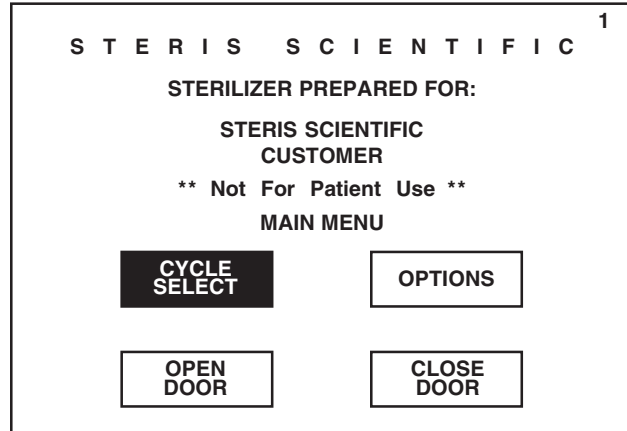

Screen #13 lists six functions that can be performed when the sterilizer is not running a cycle. To access any of the listed functions, refer to the description, included in this section, titled the same as the button on screen #13.

*Pressing **MAIN MENU** returns display to screen #1.*

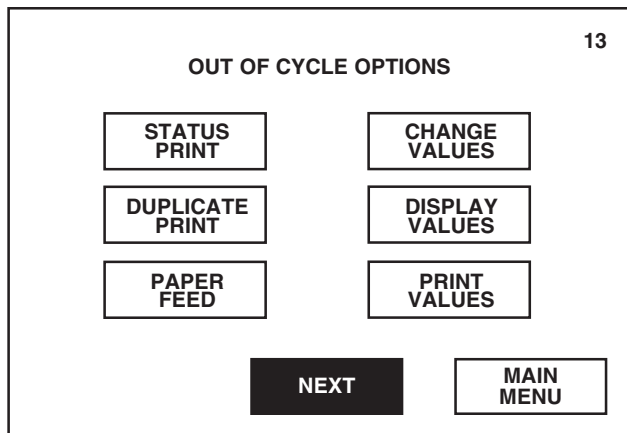

Pressing **NEXT** on screen #13 advances display to the second Out of Cycle Options menu screen.

Screen #87 lists the remaining out-of-cycle functions. To access any of the listed functions, refer to the description, included in this section, titled the same as the button on screen #87.

Pressing **PREVIOUS** returns display to screen #13.

Pressing **MAIN MENU** returns display to screen #1.

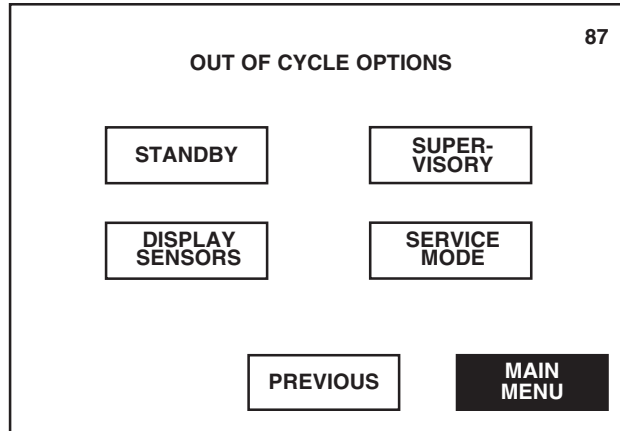

To exit the option menu screens, press **MAIN MENU** on screen #13 or #87. Display returns to the main menu (screen #1).

10.2 Status Print

Status Print is used, when the sterilizer is out of cycle, to generate a printed record of the current chamber status.

Press **STATUS PRINT** on screen #13 to automatically generate a printout listing the current temperature and pressure in the sterilizer chamber at the time the button was pressed (see Figure 10-1).

Pressing **NEXT** advances display to screen #87.

Pressing **MAIN MENU** returns display to screen #1.

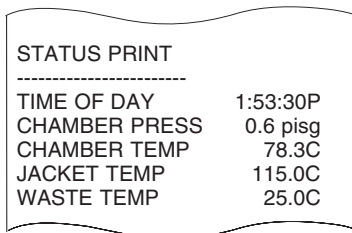
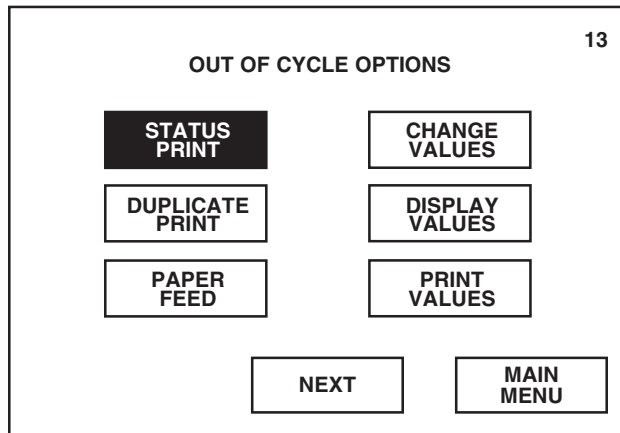

Figure 10-1. Example of Out-of-cycle Status Printout

10.3 Duplicate Print

Duplicate Print is used to instantaneously generate a duplicate printed record of the last completed cycle.

Press **DUPLICATE PRINT** on screen #13 to automatically generate a printout listing all data from the last completed cycle.

NOTE: If sterilizer was just initialized, no data will be printed.

Pressing NEXT advances display to screen #87.

Pressing MAIN MENU returns display to screen #1.

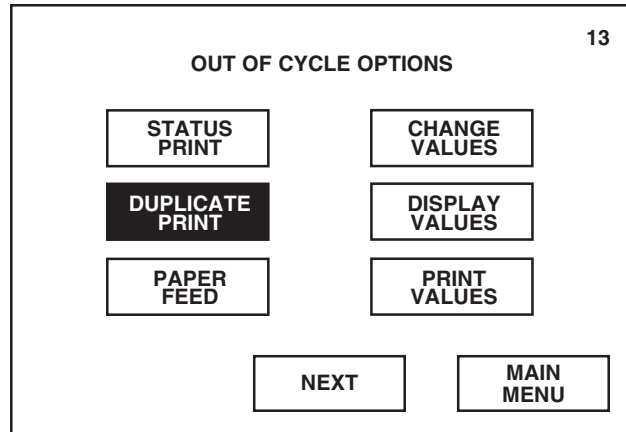

10.4 Paper Feed

Paper Feed is used to manually advance the printer paper.

Press **PAPER FEED** on screen #13 to automatically advance the printer paper up by one line.

To continually advance printer paper, press and hold **PAPER FEED**. Paper will continually advance until button is released.

Pressing NEXT advances display to screen #87.

Pressing MAIN MENU returns display to screen #1.

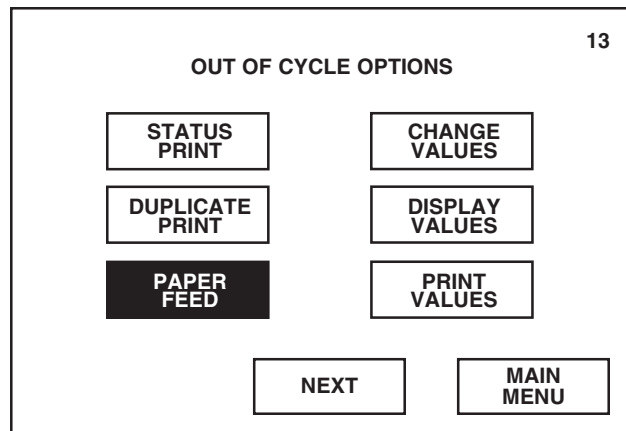

10.5 Change Values

Change Values allows access to the Change Values menu (screen #14). Operator may program the cycle values and sterilizer operating parameters from this menu screen.

Press **CHANGE VALUES** on screen #13 to advance display to the Change Values menu (screen #14). Refer to *SECTION 8, PROGRAMMING CYCLE VALUES*, and *SECTION 9, PROGRAMMING OPERATING PARAMETERS*, for information on using the Change Values option.

Pressing NEXT advances display to screen #87.

Pressing MAIN MENU returns display to screen #1.

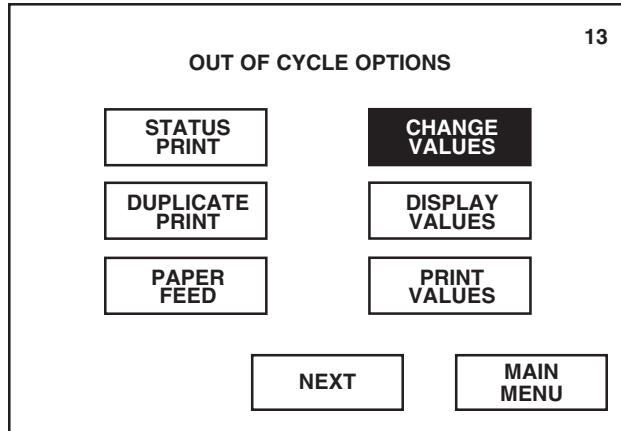

10.6 Display Values

Display Values is used to view the current programmed cycle values and sterilizer operating parameters.

1. Press **DISPLAY VALUES** on screen #13.

Pressing NEXT advances display to screen #87.

Pressing MAIN MENU returns display to screen #1.

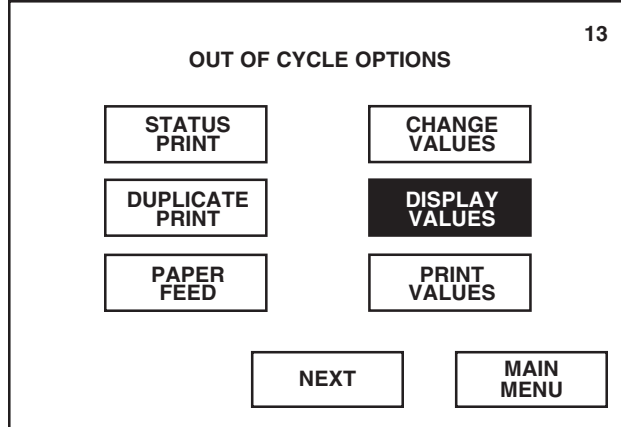

2. Screen #79 allows operator the selection of viewing any cycle value or operating parameter currently programmed. To view a specific value, refer to the following description titled the same as the button on screen #79.

Pressing RETURN returns display to screen #13.

Pressing MAIN MENU returns display to screen #1.

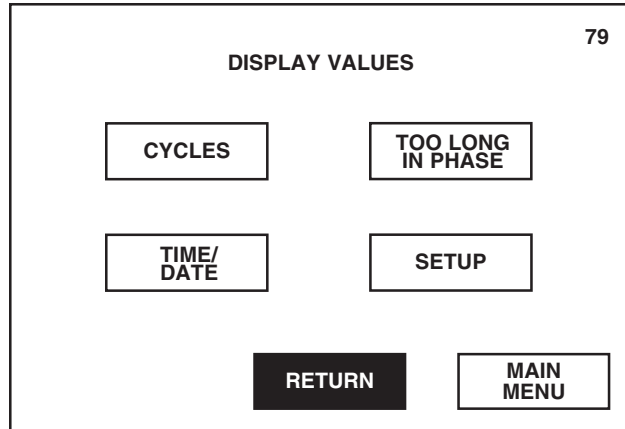

3. To exit the Display Values option, press **RETURN** on screen #79. Display returns to the first Out of Cycle Options menu (screen #13).

10.6.1 Cycles

To view the values currently programmed for a particular cycle:

1. Press **CYCLES** on screen #79.

Pressing RETURN returns display to screen #13.

Pressing MAIN MENU returns display to screen #1.

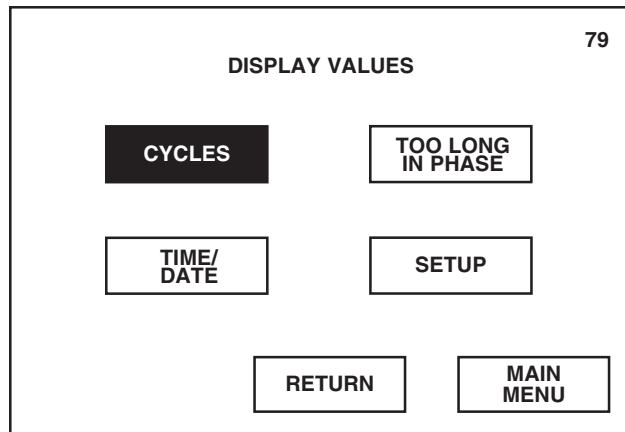

2. Press **cycle button** corresponding to the cycle and cycle values you wish to view.

For example, press **1. PREVAC** to view the cycle values programmed for the first cycle.

Pressing RETURN returns display to screen #79.

Pressing MAIN MENU returns display to screen #1.

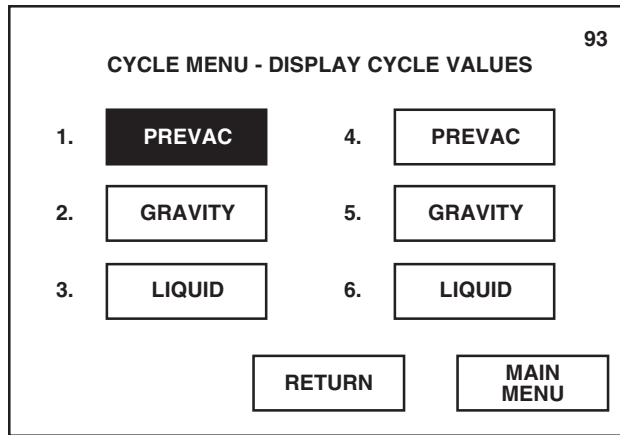

3. The first values screen appears listing some of the current cycle values programmed for the selected cycle.

Press **NEXT** to view more programmed values for the selected cycle.

Pressing CYCLE MENU returns display to screen #93.

Pressing MAIN MENU returns display to screen #1.

Cycle Name
(Cycle Type)

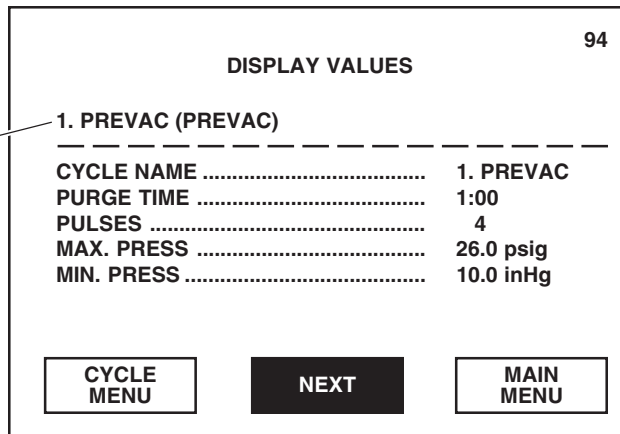

- The second values screen appears listing more cycle values programmed for the selected cycle.

If applicable, press **NEXT** to view remaining programmed values for the selected cycle.

NOTE: Depending on cycle selected, there are either two or three values screens showing the programmed cycle values.

Pressing PREVIOUS returns display to first values screen shown.

Pressing MAIN MENU returns display to screen #1.

Cycle Name
(Cycle Type)

DISPLAY VALUES		97
1. PREVAC (PREVAC)		

STER. TIME	4:00	
STER. TEMP	132.0 C	
OVERDRIVE	1.5 C	
UNDER TEMP	1.0 C	
UNDER TEMP	RESTART	
OVER TEMP	6.0 C	
PRINT INT	2 min	
<div style="display: flex; justify-content: space-around; margin-top: 10px;"> PREVIOUS NEXT MAIN MENU </div>		

- The last values screen appears listing the remaining cycle values programmed for the selected cycle.

After viewing the cycle values, press **CYCLE MENU** on the last values screen. Display returns to screen #93.

Pressing PREVIOUS returns display to second values screen shown.

Pressing MAIN MENU returns display to screen #1.

Cycle Name
(Cycle Type)

Double Door
Units Only

DISPLAY VALUES		98
1. PREVAC (PREVAC)		

VACUUM DRY	10.0 inHg	
DRY TIME	30:00	
INTERLOCK	2	
<div style="display: flex; justify-content: space-around; margin-top: 10px;"> PREVIOUS CYCLE MENU MAIN MENU </div>		

- To exit the Cycle Menu, press **RETURN** on screen #93. Display returns to the Display Values menu (screen #79).

Pressing **MAIN MENU** returns display to screen #1.

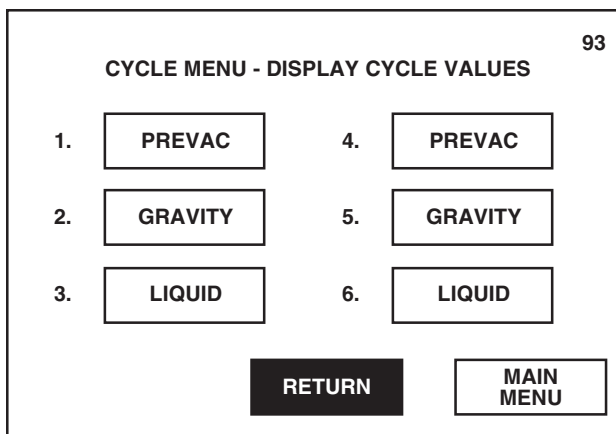

10.6.2 Time/Date

To view the current programmed time and date:

- Press **TIME/DATE** on screen #79.

Pressing **RETURN** returns display to screen #13.

Pressing **MAIN MENU** returns display to screen #1.

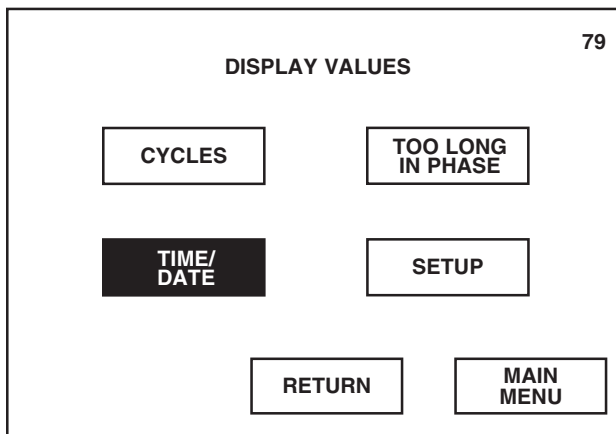

- Screen #88 lists the current time and date programmed in the sterilizer control at the moment the **TIME/DATE** button was pressed.

After viewing time and date, press **RETURN** on screen #88. Display returns to screen #79.

Pressing **MAIN MENU** returns display to screen #1.

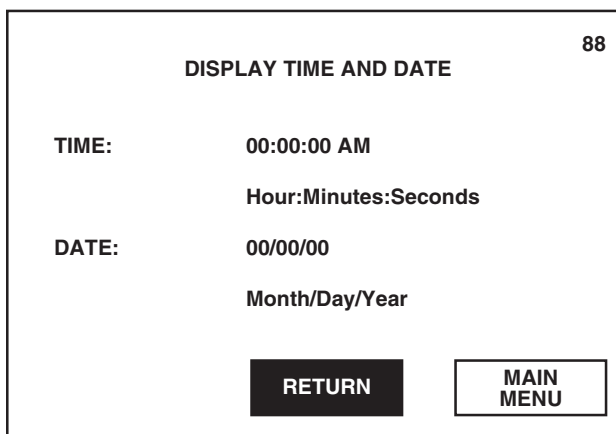

10.6.3 Too Long in Phase

To view the times currently programmed for the "too long in phase" values:

1. Press **TOO LONG IN PHASE** on screen #79.

Pressing RETURN returns display to screen #13.

Pressing MAIN MENU returns display to screen #1.

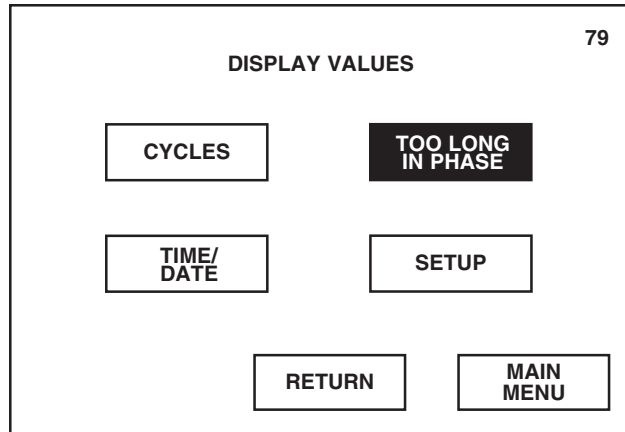

2. Screen #89 lists the current "too long in phase" values programmed in the sterilizer control.

After viewing values, press **RETURN** on screen #89. Display returns to screen #79.

Pressing MAIN MENU returns display to screen #1.

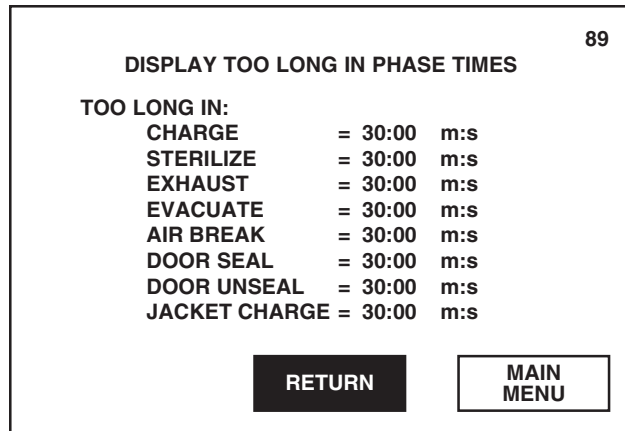

10.6.4 Setup

To view the current programmed setup values:

1. Press **SETUP** on screen #79.

Pressing RETURN returns display to screen #13.

Pressing MAIN MENU returns display to screen #1.

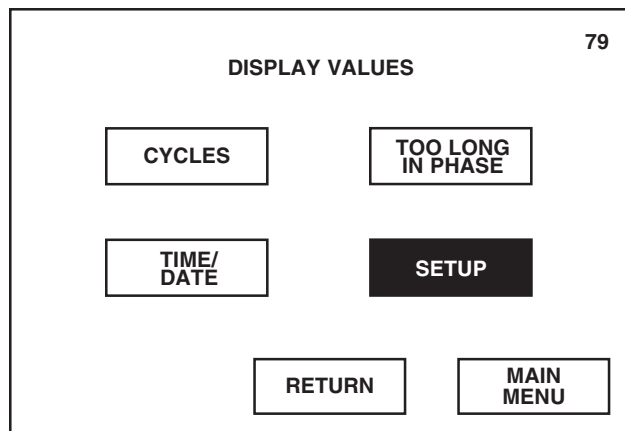

- Screen #90 lists the current pressure units, temperature units and audible signal settings programmed in the sterilizer control.

Press **NEXT** to view additional programmed setup values.

Pressing RETURN returns display to screen #79.

Pressing MAIN MENU returns display to screen #1.

90

DISPLAY SETUP VALUES

PRESSURE UNITS PSIG/INHG

TEMPERATURE UNITS CELSIUS

AUDIBLE SIGNALS:

ALARM MEDIUM

END OF CYCLE MEDIUM

TOUCHPAD MEDIUM

RETURN

NEXT

MAIN MENU

- If the utility shutdown feature is selected (programmed to function automatically), screen #102 lists the restart and shutdown times programmed for each day of the week.

Press **NEXT** to view remaining programmed setup values.

Pressing PREVIOUS returns display to screen #90.

Pressing MAIN MENU returns display to screen #1.

102

UTILITY SHUTDOWN TIMES

DAY	RESTART	SHUTDOWN
SUNDAY	6:00:00 AM	7:00:00 PM
MONDAY	6:00:00 AM	7:00:00 PM
TUESDAY	6:00:00 AM	7:00:00 PM
WEDNESDAY	6:00:00 AM	7:00:00 PM
THURSDAY	6:00:00 AM	7:00:00 PM
FRIDAY	6:00:00 AM	7:00:00 PM
SATURDAY	6:00:00 AM	7:00:00 PM

PREVIOUS

NEXT

MAIN MENU

- Screen #103 lists the current settings programmed for utility shutdown, print format, duplicate print and printer status.

After viewing setup values, press **RETURN** on screen #103. Display returns to screen #79.

Pressing PREVIOUS returns display to screen #102 or #90.

Pressing MAIN MENU returns display to screen #1.

103

DISPLAY SETUP VALUES

UTILITY SHUTDOWN AUTOMATIC

PRINT FORMAT FULL

DUPLICATE PRINT YES

TURN OFF PRINTER NO

PREVIOUS

RETURN

MAIN MENU

10.7 Print Values

Print Values is used to generate a printed record of all the programmed values, all the values changed since the last printout, or the values of a particular cycle.

10.7.1 All Values

1. Press **PRINT VALUES** on screen #13.

Pressing NEXT advances display to screen #87.

Pressing MAIN MENU returns display to screen #1.

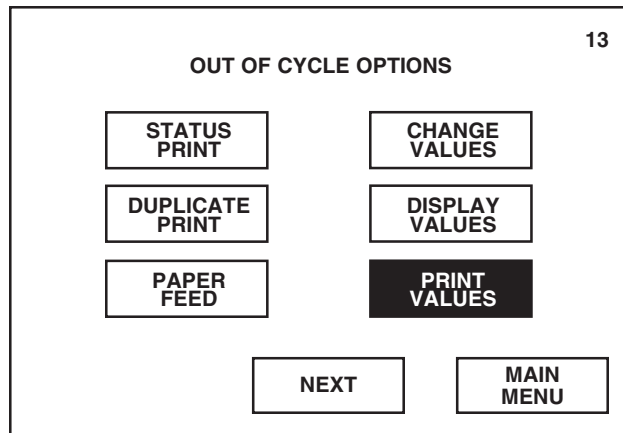

2. Press **ALL VALUES**. Control automatically generates a printout of all the programmed values (cycle values for all six processing cycles and all sterilizer operating parameters).

Display automatically returns to screen #13 once a print values selection is made.

Pressing RETURN returns display to screen #13.

Pressing MAIN MENU returns display to screen #1.

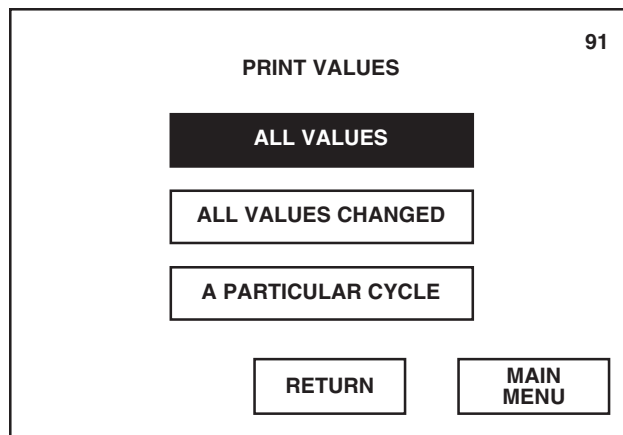

10.7.2 All Values Changed

1. Press **PRINT VALUES** on screen #13.

Pressing NEXT advances display to screen #87.

Pressing MAIN MENU returns display to screen #1.

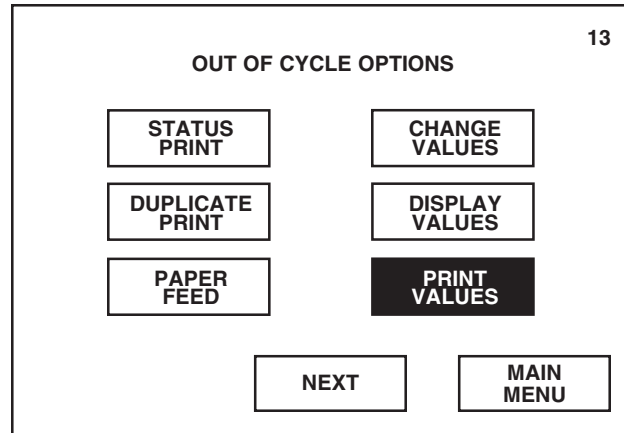

2. Press **ALL VALUES CHANGED**. Control automatically generates a print-out of all the values changed since the last time cycle values and/or operating parameters were changed.

Display automatically returns to screen #13 once a print values selection is made.

Pressing RETURN returns display to screen #13.

Pressing MAIN MENU returns display to screen #1.

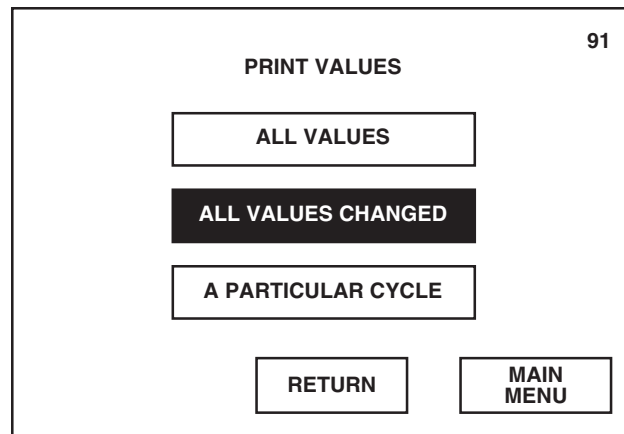

10.7.3 A Particular Cycle

1. Press **PRINT VALUES** on screen #13.

Pressing NEXT advances display to screen #87.

Pressing MAIN MENU returns display to screen #1.

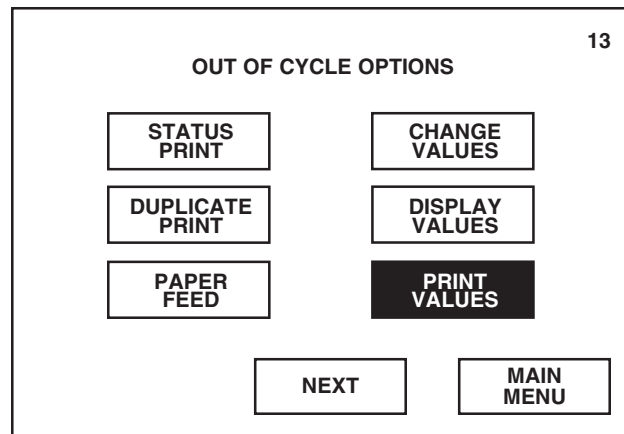

2. Press **A PARTICULAR CYCLE**.

Pressing RETURN returns display to screen #13.

Pressing MAIN MENU returns display to screen #1.

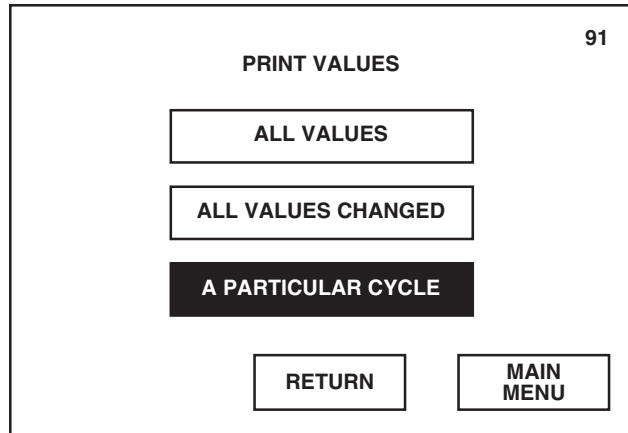

3. Press **cycle button** corresponding to the cycle and cycle values you wish to print out. Control automatically generates a printout of the cycle values programmed for the selected cycle.

Display automatically returns to screen #13 once a cycle button is selected.

Pressing RETURN returns display to screen #91.

Pressing MAIN MENU returns display to screen #1.

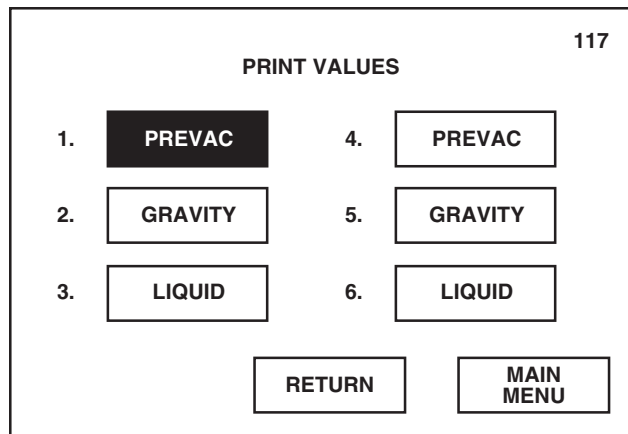

10.8 Standby

The Standby option allows sterilizer to be manually switched from the Operating mode to a Standby mode. When in Standby mode, all valves to the sterilizer are off, including jacket steam and water.

NOTE: Sterilizer should be manually placed in the Standby mode if automatic utility shutdown feature (SECTION 9.4.3) is not selected and the sterilizer will not be used for an extended period of time (e.g., overnight).

1. Press **STANDBY** on screen #87.

Pressing PREVIOUS returns display to screen #13.

Pressing MAIN MENU returns display to screen #1.

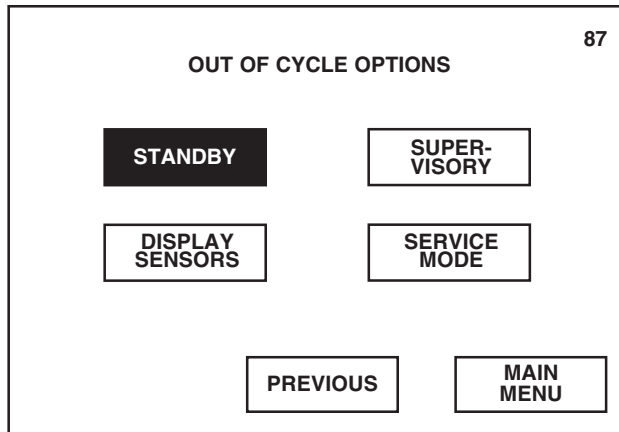

2. All valves to the sterilizer are automatically shut off and display returns to screen #0.

Pressing HEXAWAVE advances display to screen #1, turns on all valves and places sterilizer in the Operating mode.

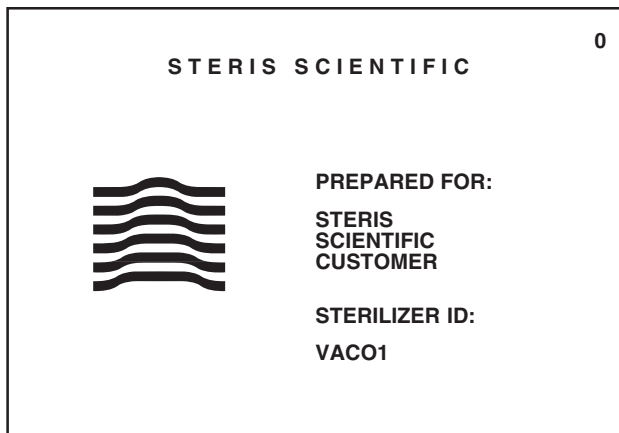

10.9 Display Sensors

Display Sensors is used to view the current temperature and pressure readings of the sterilizer.

1. Press **DISPLAY SENSORS** on screen #87.

Pressing PREVIOUS returns display to screen #13.

Pressing MAIN MENU returns display to screen #1.

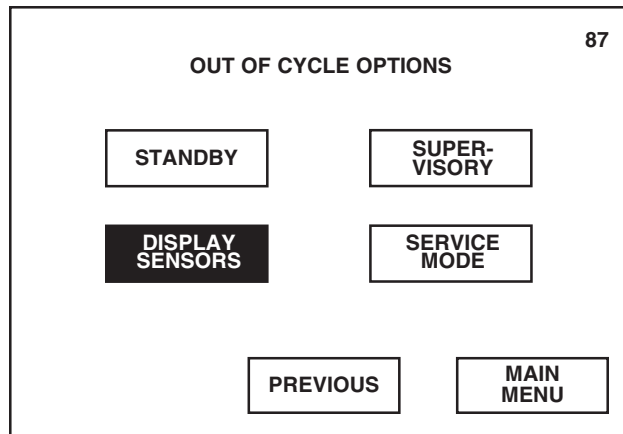

2. Screen #92 lists the readings recorded by the sterilizer pressure and temperature sensors at the time the DISPLAY SENSORS button was pressed.

After viewing, press **RETURN**. Display returns to screen #87.

Pressing MAIN MENU returns display to screen #1.

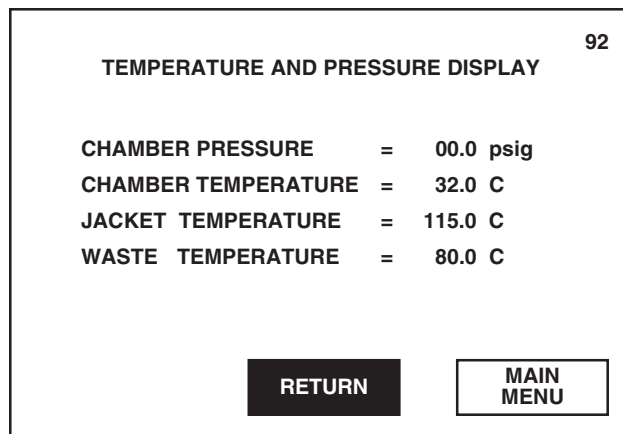

10.10 Supervisory

Supervisory allows access to the Supervisory mode. From this mode, the authorized user may:

- » change the customer name and sterilizer ID number as it appears on the display and printouts
- » reset all cycle values and sterilizer operating parameters to the default values
- » view and change the programmed access codes
- » download cycle data through the optional RS-232 communications port
- » if sterilizer is equipped with double doors, override programmed interlock feature.

NOTE: Access to the Supervisory mode is limited by requiring entry of a four-digit code before advancing.

1. Press **SUPERVISORY** on screen #87.

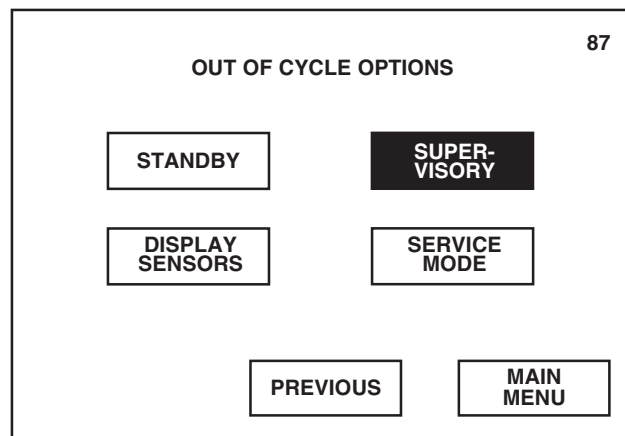

Pressing **PREVIOUS** returns display to screen #13.

Pressing **MAIN MENU** returns display to screen #1.

2. Enter four-digit supervisory access code using the numeric keypad. Default access code is 000. Once code is correctly entered, press **ENTER**. Printer records the date and time when Supervisory mode was accessed.

NOTE: If incorrect code is entered, pressing **ENTER** denies access to the Supervisory mode and returns display to screen #1.

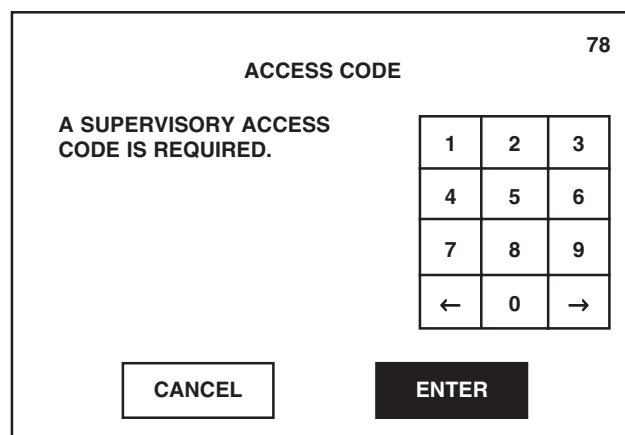

Pressing ← or → on numeric keypad moves the entry location to the left or right, respectively.

Pressing **CANCEL** returns display to screen #1.

NOTE: Call **STERIS Engineering Service** if Supervisory access code is forgotten.

3. Screen #51 lists the functions that can be performed in the Supervisory mode. To perform a specific function, refer to the following description titled the same as the button on screen #51.

Pressing RETURN returns display to screen #87.

Pressing MAIN MENU returns display screen #1.

If sterilizer is equipped with double doors, pressing NEXT advances display to screen #61.

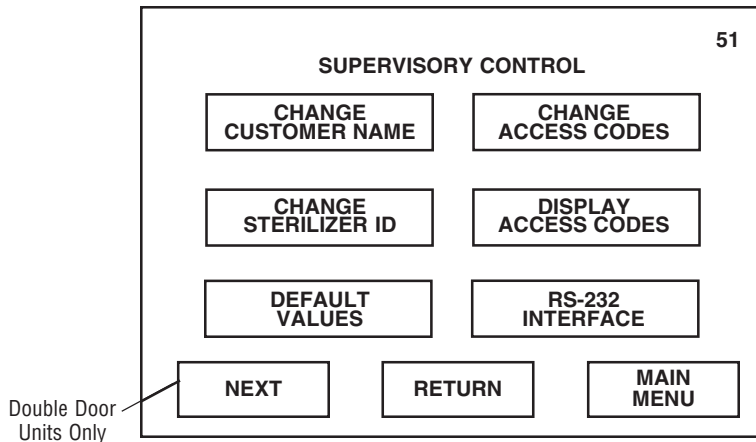

4. If sterilizer is equipped with double doors, press **NEXT** on screen #51.

Pressing RETURN returns display to screen #87.

Pressing MAIN MENU returns display screen #1.

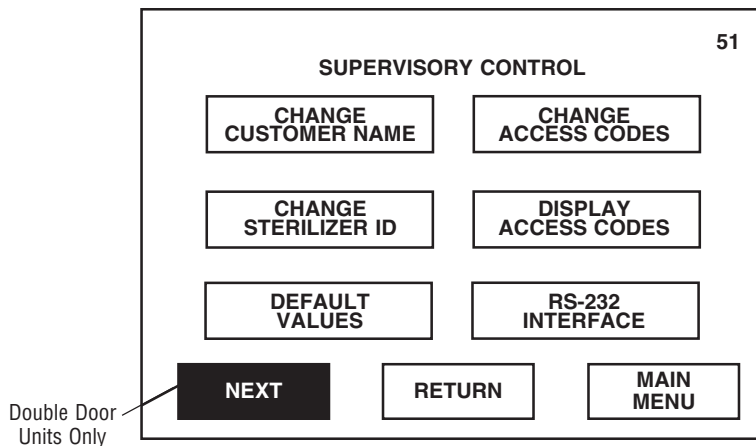

5. Screen #61 allows supervisor to override the programmed interlock setting. To perform this function, refer to "Override Interlocks" later in this section. Press **PREVIOUS** to return display to screen #51.

Pressing MAIN MENU returns display screen #1.

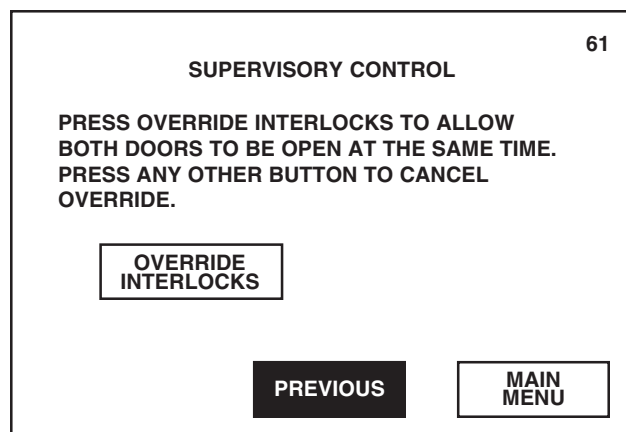

6. To exit the Supervisory mode, press RETURN on screen #51. Display returns to the second Out of Cycle Options menu (screen #87).

10.10.1 Change Customer Name

This function allows supervisor to change the customer name as it appears on screens #0 and #1.

1. Press **CHANGE CUSTOMER NAME** on screen #51.

Pressing RETURN returns display to screen #87.

Pressing MAIN MENU returns display screen #1.

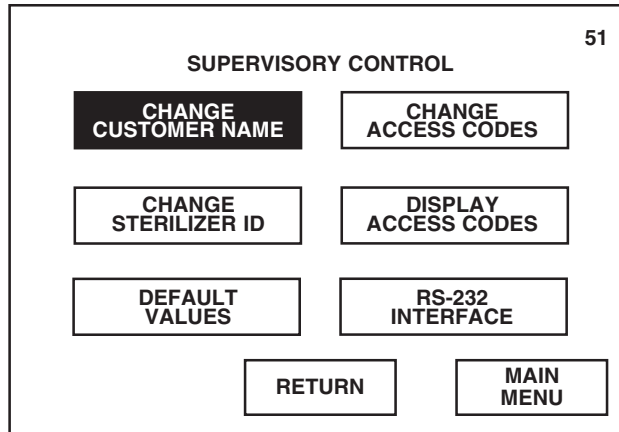

2. Enter customer name using the alpha-numeric keypad. Customer name appears at bottom of display as it is being entered. Once name is correctly entered, press **RETURN**. Control saves the changed name and returns display to screen #51.

Pressing ← or → moves the cursor to the left or right, respectively.

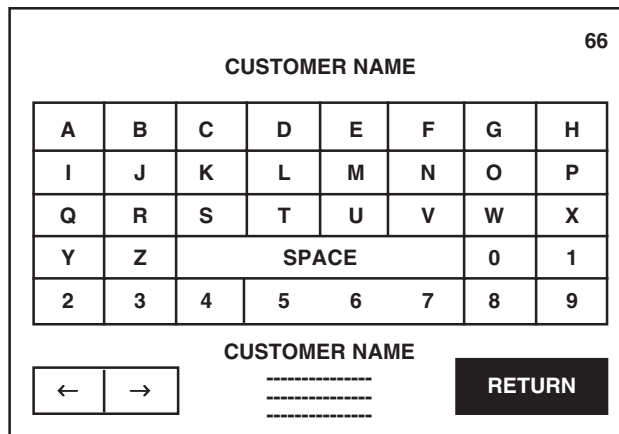

10.10.2 Change Sterilizer ID

This function allows supervisor to change the sterilizer ID number as it appears on screen #0 and at the beginning of each in-cycle printout.

1. Press **CHANGE STERILIZER ID** on screen #51.

Pressing RETURN returns display to screen #87.

Pressing MAIN MENU returns display screen #1.

51

SUPERVISORY CONTROL

CHANGE CUSTOMER NAME	CHANGE ACCESS CODES
CHANGE STERILIZER ID	DISPLAY ACCESS CODES
DEFAULT VALUES	RS-232 INTERFACE
RETURN	MAIN MENU

2. Enter identification name using the alpha-numeric keypad. Identification name appears at bottom of display as it is being entered. Once name is correctly entered, press **RETURN**. Control saves the changed name and returns display to screen #51.

Pressing ← or → moves the cursor to the left or right, respectively.

17

STERILIZER ID

A	B	C	D	E	F	G	H	
I	J	K	L	M	N	O	P	
Q	R	S	T	U	V	W	X	
Y	Z	SPACE				0	1	
2	3	4	5	6	7	8	9	

←

→

STERILIZER ID

RETURN

10.10.3 Default Values

This function allows supervisor to reset all values to the factory-programmed values.

Press **DEFAULT VALUES** on screen #51 to automatically change all cycle values and sterilizer operating parameters back to the factory-programmed (default) values.

Pressing RETURN returns display to screen #87.

Pressing MAIN MENU returns display screen #1.

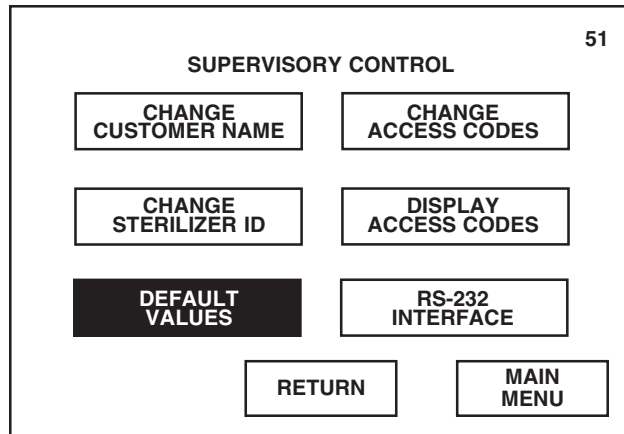

10.10.4 Change Access Codes

This function allows supervisor to activate the access code feature and program the separate four-digit codes which will limit usage of the sterilizer, access to the Change Values menu and access to the Supervisory mode. Once the access code feature is activated, the assigned four-digit code must be correctly entered on the touch screen before the control will advance.

Change Values Access Codes

To activate and assign access codes which prevent unauthorized entry into the Change Values menu:

1. Press **CHANGE ACCESS CODES** on screen #51.

Pressing RETURN returns display to screen #87.

Pressing MAIN MENU returns display screen #1.

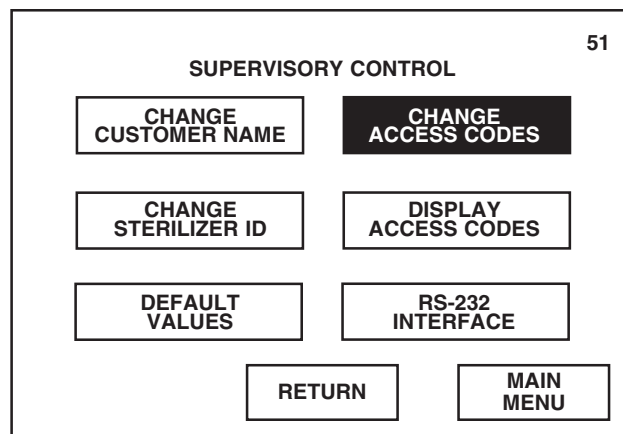

2. Press **CHANGE VALUES**.

Pressing **RETURN** returns display to screen #51.

Pressing **MAIN MENU** returns display to screen #1.

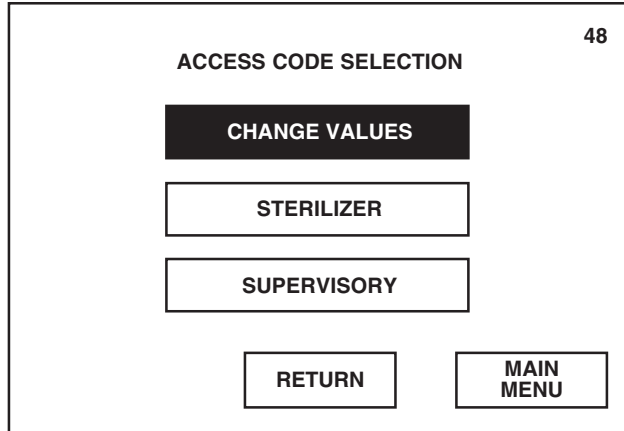

3. Press **YES** to activate the access code feature.

Pressing **NO** refuses the access code option and returns display to screen #48.



NOTE: Access code feature cannot be individually activated for each operator. Once the access code feature is activated, all designated operators must enter their assigned access code before advancing.

4. Access to the Change Values menu can be limited to six authorized operators. A separate access code can be programmed for each operator. To change an operator's name and access code, press the appropriate **operator button**.

Pressing **RETURN** returns display to screen #48.

Pressing **MAIN MENU** returns display to screen #1.

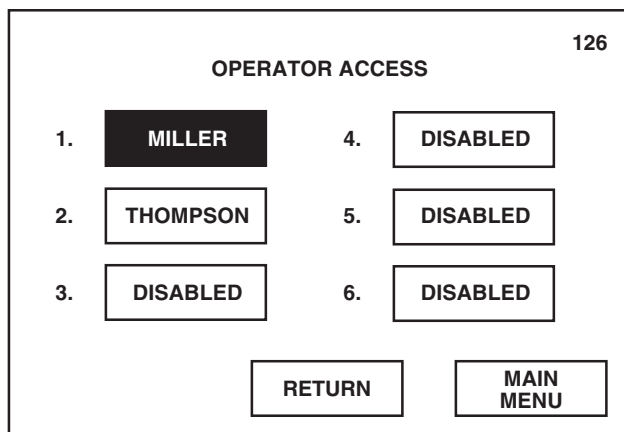

5. Enter operator's name, maximum of 9 characters, using the alpha-numeric keypad. Operator name appears on display as it is being entered. Once name is correctly entered, press **RETURN**.

NOTE: Operator name appears inside corresponding touch screen button on screen #126.

Pressing ← or → moves the cursor to the left or right, respectively.

CHANGE VALUES - OPERATOR NAME								77
A	B	C	D	E	F	G	H	
I	J	K	L	M	N	O	P	
Q	R	S	T	U	V	W	X	
Y	Z	SPACE				0	1	
2	3	4	5	6	7	8	9	
← →		OPERATOR NAME -----					RETURN	

6. Enter the **old access code** (access code currently programmed for the selected operator) using the numeric keypad. Access code appears on display as it is being entered. Once the old code is correctly entered, press **ENTER**.

NOTE: Default access code is 0000.

Pressing ← or → on numeric keypad moves the entry location to the left or right, respectively.

Pressing CANCEL returns display to screen #48.

CHANGE VALUES ACCESS CODE			82
ENTER THE OLD ACCESS CODE.			
1	2	3	
4	5	6	
7	8	9	
←	0	→	
CANCEL		ENTER	

7. Enter the **new access code** using the numeric keypad. New access code appears on display as it is being entered. Once the new code is correctly entered, press **ENTER**.

Pressing ← or → on numeric keypad moves the entry location to the left or right, respectively.

Pressing CANCEL returns display to screen #48 without changing the current access code.

84

CHANGE VALUES ACCESS CODE

ENTER THE NEW ACCESS CODE.

1	2	3
4	5	6
7	8	9
←	0	→

CANCEL ENTER

8. Screen #111 allows supervisor to designate which values can not be changed by the operator. To lock out a specific value, press the corresponding **values button**.

For example: Press SETUP to prevent the operator from changing the setup values. Once pressed, the values button reads LOCKOUT.

NOTE: Pressing CYCLES advances display to screen #112. Screen #112 allows supervisor to designate specific cycles which cannot be changed by the operator.

Once all desired values are locked out, press **RETURN**.

111

LOCKOUT VALUES

CYCLES TOO LONG IN PHASE

TIME/DATE SETUP

RETURN

9. Once access codes have been entered for all designated operators, press **RETURN** on screen #126. Control saves all changes made and display returns to screen #48.

The operator will now be required to enter the new access code before the control will advance to the Change Values menu (screen #14), allowing programming of only the designated cycle values and operating parameters.

Pressing MAIN MENU returns display to screen #1.

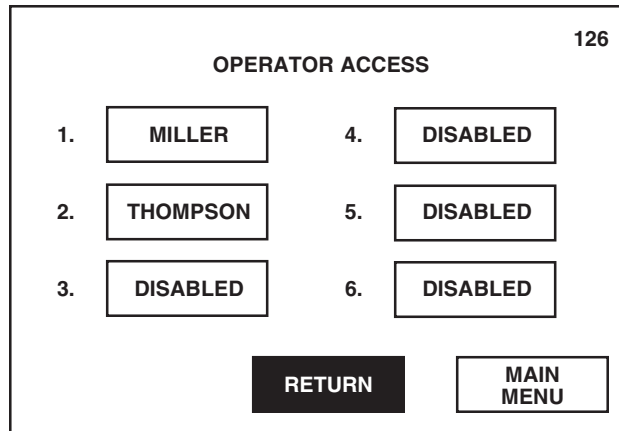

10. After all access codes have been entered, press RETURN on screen #48. Display returns to screen #51.

Sterilizer Operation Access Codes

To activate and assign access codes which prevent the sterilizer from being operated:

1. Press **CHANGE ACCESS CODES** on screen #51.

Pressing RETURN returns display to screen #87.

Pressing MAIN MENU returns display to screen #1.

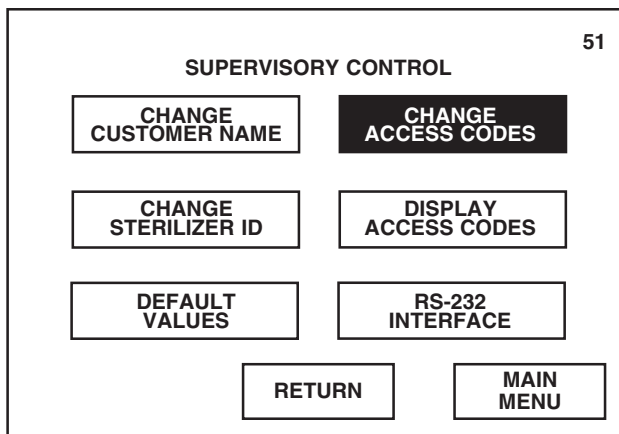

2. Press **STERILIZER**.

Pressing **RETURN** returns display to screen #51.

Pressing **MAIN MENU** returns display to screen #1.

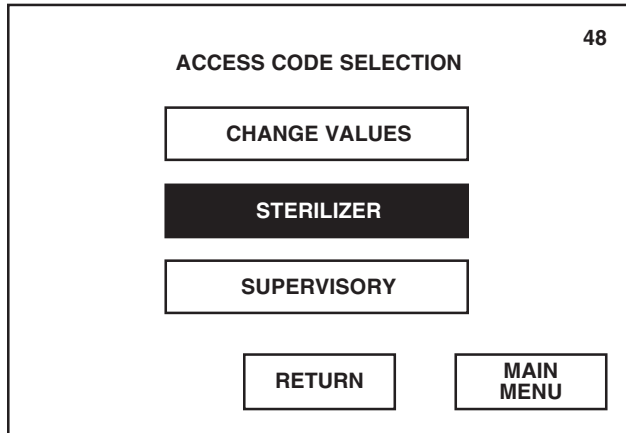

3. Press **YES** to activate the access code feature.

Pressing **NO** refuses the access code option and returns display to screen #48.

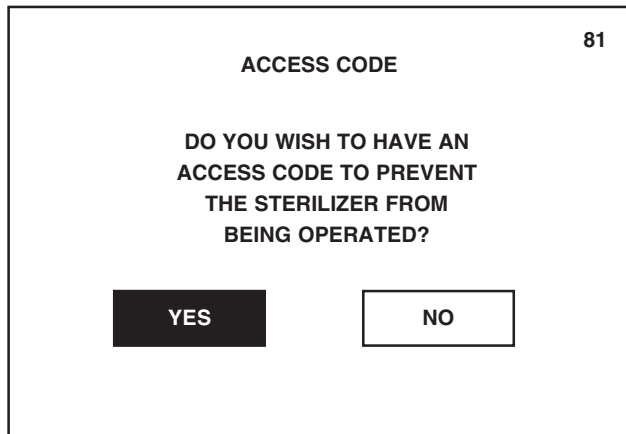

NOTE: Access code feature cannot be individually activated for each operator. Once the access code feature is activated, all designated operators must enter their assigned access code before advancing.

4. Sterilizer usage can be limited to six authorized operators. A separate access code can be programmed for each operator. To change an operator's name and access code, press the appropriate **operator button**.

Pressing **RETURN** returns display to screen #48.

Pressing **MAIN MENU** returns display to screen #1.

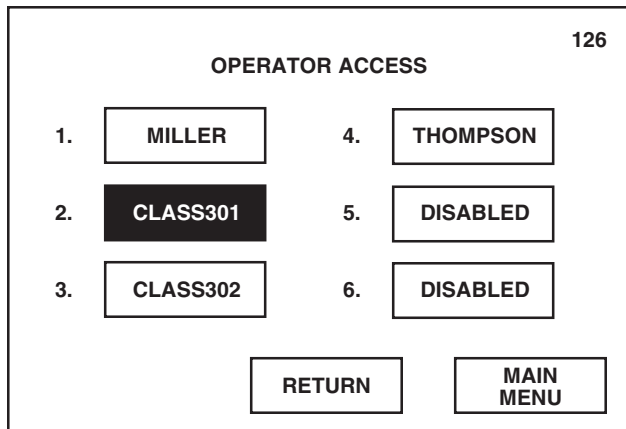

5. Enter operator's name, maximum of 9 characters, using the alpha-numeric keypad. Operator name appears at bottom of display as it is being entered. Once name is correctly entered, press **RETURN**.

NOTE: Operator name appears inside the corresponding touch screen button on screen #126 and at the beginning of each in-cycle printout.

Pressing ← or → moves the cursor to the left or right, respectively.

STERILIZER - OPERATOR NAME								77
A	B	C	D	E	F	G	H	
I	J	K	L	M	N	O	P	
Q	R	S	T	U	V	W	X	
Y	Z	SPACE				0	1	
2	3	4	5	6	7	8	9	
←		→		OPERATOR NAME				RETURN

6. Enter the **old access code** (access code currently programmed for the selected operator) using the numeric keypad. Access code appears on display as it is being entered. Once the old code is correctly entered, press **ENTER**.

NOTE: Default access code is 0000.

Pressing ← or → on numeric keypad moves the entry location to the left or right, respectively.

Pressing CANCEL returns display to screen #48.

STERILIZER OPERATION ACCESS CODE						83
ENTER THE OLD ACCESS CODE.						
1	2	3				
4	5	6				
7	8	9				
←	0	→				
CANCEL			ENTER			

7. Enter the **new access code** using the numeric keypad. New access code appears on display as it is being entered. Once the new code is correctly entered, press **ENTER**.

Pressing ← or → on numeric keypad moves the entry location to the left or right, respectively.

Pressing CANCEL returns display to screen #48 without changing the current access code.

STERILIZER OPERATION ACCESS CODE			85
ENTER THE NEW ACCESS CODE.			
1	2	3	
4	5	6	
7	8	9	
←	0	→	
CANCEL		ENTER	

8. Once access codes have been entered for all designated operators, press **RETURN** on screen #126. Control saves all changes made and display returns to screen #48.

The operator will now be required to enter the new access code before operating the sterilizer.

Pressing MAIN MENU returns display to screen #1.

Pressing RETURN returns display to screen #87.

OPERATOR ACCESS		126	
1.	MILLER	4.	THOMPSON
2.	CLASS301	5.	DISABLED
3.	CLASS302	6.	DISABLED
RETURN		MAIN MENU	

9. After all access codes have been entered, press RETURN on screen #48. Display returns to screen #51.

Supervisory Access Code

To change the access code which prevents unauthorized entry into the Supervisory mode:

1. Press **CHANGE ACCESS CODES** on screen #51.

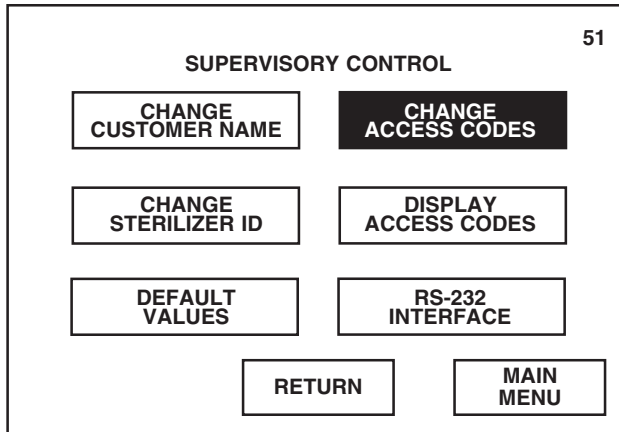

Pressing MAIN MENU returns display to screen #1.

Pressing RETURN returns display to screen #51.

2. Press **SUPERVISORY**.

NOTE: Access code is always activated for entry into the Supervisory mode.

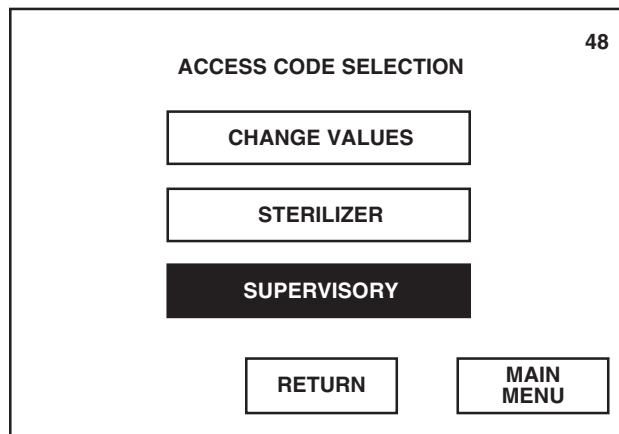

Pressing MAIN MENU returns display to screen #1.

pressing ← or → on numeric keypad moves the entry location to the left or right, respectively.

3. Enter the **old access code** (access code currently programmed) using the numeric keypad. Access code appears on display as it is being entered. Once the old code is correctly entered, press **ENTER**.

NOTE: Default access code is 0000. Call STERIS Engineering Service if Supervisory access code is forgotten.

Pressing CANCEL returns display to screen #48.

Pressing ← or → on numeric keypad moves the entry location to the left or right, respectively.

SUPERVISORY ACCESS CODE			83
ENTER THE OLD ACCESS CODE.			
1	2	3	
4	5	6	
7	8	9	
←	0	→	
CANCEL		ENTER	

4. Enter the **new access code** using the numeric keypad. New access code appears on display as it is being entered. Once the new code is correctly entered, press **ENTER**. Control saves the changes made and returns display to screen #48.

Pressing CANCEL returns display to screen #48 without changing the current access code.

Pressing MAIN MENU returns display to screen #1.

SUPERVISORY ACCESS CODE			85
ENTER THE NEW ACCESS CODE.			
1	2	3	
4	5	6	
7	8	9	
←	0	→	
CANCEL		ENTER	

5. The supervisor must now enter the new access code in order to access the Supervisory mode.
6. Once all access codes (change values, sterilizer and supervisory) have been entered, press **RETURN** on screen #48. Display returns to screen #51.

Pressing RETURN returns display to screen #87.

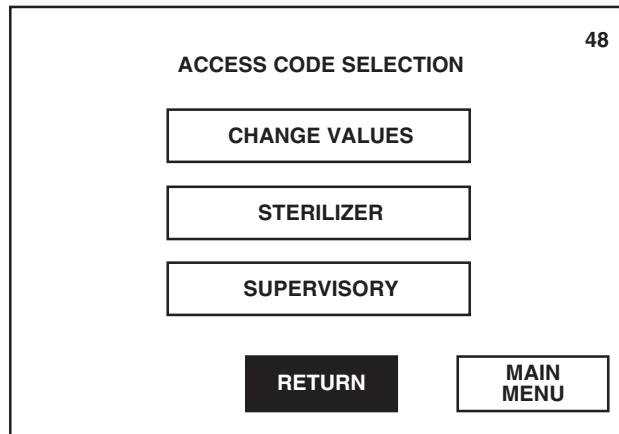

10.10.5 Display Access Codes

This function allows supervisor to view the access codes currently programmed for each operator.

1. Press **DISPLAY ACCESS CODES** on screen #51.

Pressing MAIN MENU returns display to screen #1.

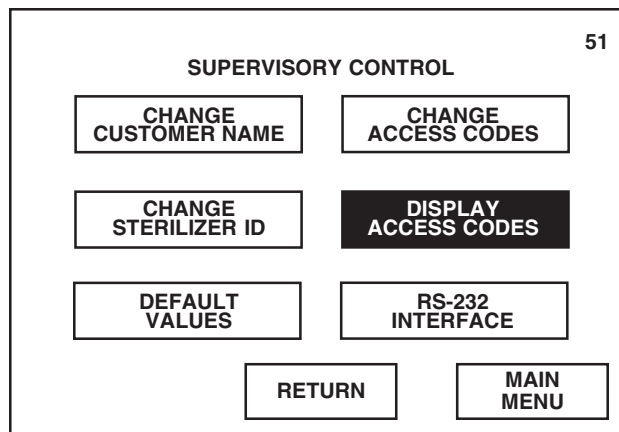

- Screen #46 lists the six operator names and corresponding access codes programmed to prevent use of the sterilizer. Current setting of the access code feature (enabled [turned on] or disabled [turned off]) appears under the screen title.

Press **CHANGE VALUES CODES** to view the other programmed access codes.

Pressing PRINT CODES automatically generates a printout of all programmed Sterilizer and Change Values access codes.

Pressing RETURN returns display to screen #51.

STERILIZER ACCESS CODES			46
ACCESS ENABLED			
OPERATOR	NAME	ACCESS CODE	
1.	MILLER	1000	
2.	CLASS301	3000	
3.	CLASS302	5000	
4.	THOMPSON	7000	
5.	DISABLED	0000	
6.	DISABLED	0000	

- Screen #46 now lists the six operator names and corresponding access codes programmed to prevent entry into the Change Values menu. Current setting of the access code feature (enabled [turned on] or disabled [turned off]) appears under the screen title.

After viewing access codes, press **RETURN**. Display returns to screen #51.

Pressing PRINT CODES automatically generates a printout of all programmed Sterilizer and Change Values access codes.

Pressing STERIL. ACCESS CODES changes the listing on screen #46 to show the programmed Sterilizer access codes.

CHANGE VALUES ACCESS CODES			46
ACCESS ENABLED			
OPERATOR	NAME	ACCESS CODE	
1.	MILLER	1000	
2.	THOMPSON	8000	
3.	DISABLED	0000	
4.	DISABLED	0000	
5.	DISABLED	0000	
6.	DISABLED	0000	

10.10.6 RS-232 Interface

This function allows supervisor to download cycle data into the device (either a computer or printer) connected at the RS-232 interface port.

1. Press **RS-232 INTERFACE** on screen #51.

Pressing RETURN returns display to screen #87.

Pressing MAIN MENU returns display to screen #1.

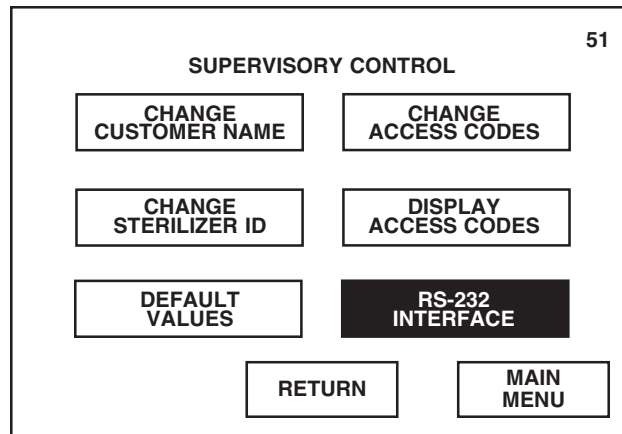

2. Screen #60 allows supervisor to indicate the device which will receive the downloaded cycle data. Select the correct device by pressing the appropriate button. Current device setting appears under the screen title.

Display automatically returns to screen #51 once a device is selected.

Pressing CANCEL returns display to screen #51.

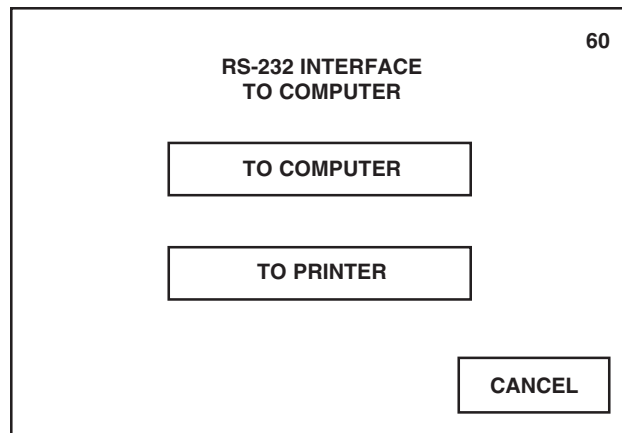

- To setup computer interface, plug a null modem RS-232 cable from COM1 of the sterilizer control to COM1 or COM2 of a personal computer. The data may be retrieved from the computer by use of a standard communication software, or by use of the STERIS RS-232 software program. The STERIS RS-232 software program will retrieve the data and store it in a pre-defined file.
- To setup printer interface, plug a null modem RS-232 cable from COM1 of the sterilizer control to the printer.

10.10.7 Override Interlocks

If sterilizer is equipped with double doors, this function allows supervisor to override the programmed interlock type.

1. Press **NEXT** on screen #51.

NOTE: NEXT button appears on screen #51 only if sterilizer is equipped with double doors.

Pressing RETURN returns display to screen #87.

Pressing MAIN MENU returns display screen #1.

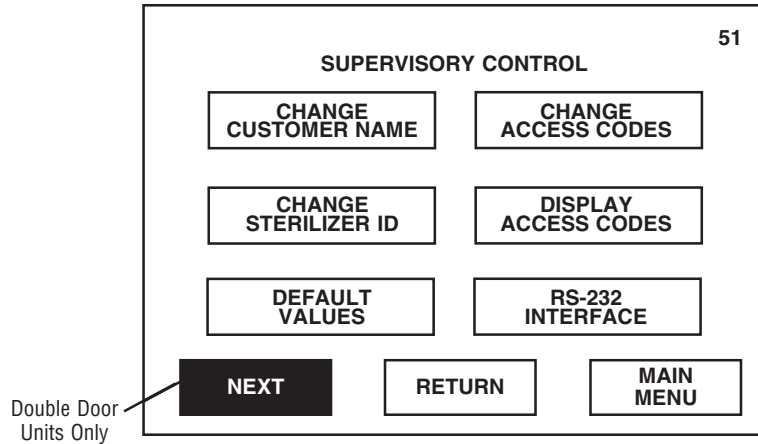

2. Press **OVERVERRIDE INTERLOCKS** to unseal each door, allowing both load and unload end doors to be open at the same time.

Pressing PREVIOUS returns display to screen #51.

Pressing MAIN MENU returns display screen #1.

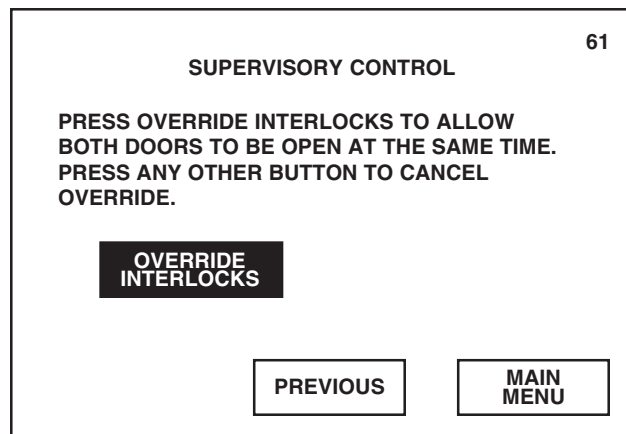

3. To exit override option, press **PREVIOUS** on screen #61. Display returns to screen #51.

Pressing MAIN MENU returns display screen #1.

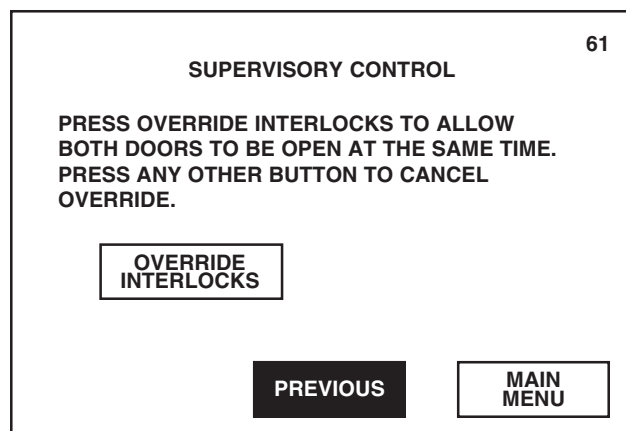

10.11 Service Mode

Service mode is used to calibrate the sterilizer sensors, test input/output of the sterilizer sensors, control alarm and maintenance functions and change all cycle values and operating parameters.

1. Press **SERVICE MODE** on screen #87.

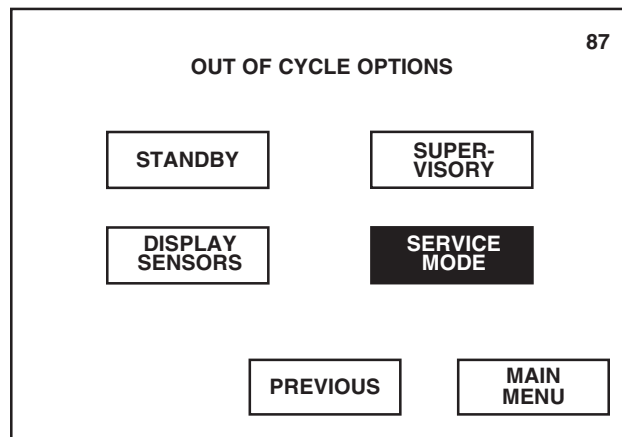

Pressing PREVIOUS returns display to screen #13.

Pressing MAIN MENU returns display to screen #1.

2. Access to the Service mode should be limited to authorized service technicians only. Refer to STERIS Maintenance Procedures, P-764326-797, for information on the Service mode.

Press **CANCEL** to return display to the second Out of Cycle Options menu (screen #87).

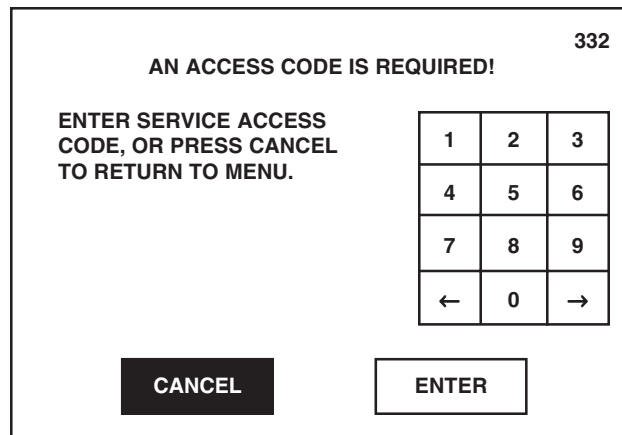

Pressing ENTER advances display to first Service mode menu (screen #115) only if correct access code was entered.

11.1 Preventive Maintenance Schedule

⚠ WARNING – SHOCK AND BURN HAZARD: Regularly scheduled preventive maintenance is required for safe and reliable operation of this equipment. Contact your STERIS Service Representative to schedule preventive maintenance.

⚠ WARNING – PERSONAL INJURY OR EQUIPMENT DAMAGE HAZARD: Repairs and adjustments to this equipment must be made only by fully qualified service personnel. Maintenance performed by inexperienced, unqualified persons or installation of unauthorized parts could cause personal injury or result in costly equipment damage.

Maintenance procedures described in *SECTIONS 11 AND 13* must be performed regularly at the indicated intervals, using the maintenance schedule in **Table 7-1** as a guide. Local conditions (water quality, usage, etc.) may require more frequent maintenance than indicated. Refer to *MAINTENANCE MANUAL, 764330-240* for replacement parts list.

Customer should maintain a record of all maintenance procedures performed on the sterilizer.

If a problem occurs, refer to *SECTION 12, TROUBLESHOOTING*.

NOTE: Never permit unqualified persons to service the sterilizer.

Table 11-1. Preventive Maintenance Schedule for Century Sterilizer

Service Required	Minimum Frequency
1.0 PREPARATION FOR PREVENTIVE MAINTENANCE	
1.1 Discuss equipment with operators and check printouts.	6x per year
1.2 Follow appropriate safety procedures; prepare unit for preventive maintenance.	6x per year
2.0 DOOR ASSEMBLY (EACH DOOR ON A DOUBLE DOOR UNIT)	
2.1 Verify proper door and door proximity switch operation. Adjust switch(s) if needed.	6x per year
2.2 Check condition of door gasket for wear and tear. Replace as needed.	6x per year
2.3 Verify proper tension on power door cable (sliding door units, only).	6x per year

Table 11-1. Preventive Maintenance Schedule for Century Sterilizer (continued)

Service Required	Minimum Frequency
<p>3.0 VALVES</p> <p>3.1 Verify each hand valve operates smoothly, check valve packing for leaks, rebuild or replace as needed.</p> <ul style="list-style-type: none"> • Steam supply valve. • Water supply valve. <p>3.2 Inspect all check valves. Repair/replace if necessary.</p> <p>3.3 Rebuild steam supply manifold.</p> <p>3.4 Rebuild all solenoid valves.</p> <p>3.5 Rebuild steam control valve (PRV).</p> <p>3.6 Verify proper setting/flow rate of flow control valves. Replace if needed.</p> <p>3.7 Verify that safety valve is not leaking.</p> <p>3.8 Replace safety valve.</p>	<p>6x per year</p> <p>6x per year</p> <p>1x per year</p> <p>1x per year</p> <p>1x per year</p> <p>2x per year</p> <p>6x per year</p> <p>1x per year</p>
<p>4.0 MISC PIPING COMPONENTS</p> <p>4.1 Inspect steam strainer for debris, clean as needed.</p> <p>4.2 Inspect water strainer for debris, clean as needed.</p> <p>4.3 Inspect jacket strainer for debris, clean as needed.</p> <p>4.4 Inspect chamber drain strainer for debris, clean as needed.</p> <p>4.5 Replace air filter cartridge.</p> <p>4.6 Chamber and jacket gauge(s) - verify proper operation. Replace if needed.</p> <p>4.7 Rebuild chamber and jacket traps.</p> <p>4.8 Verify that there are no leaks.</p> <p>4.9 Verify that door lock piston operates correctly.</p>	<p>2x per year</p> <p>2x per year</p> <p>2x per year</p> <p>6x per year</p> <p>1x per year</p> <p>6x per year</p> <p>1x per year</p> <p>6x per year</p> <p>6x per year</p>
<p>5.0 CONTROL</p> <p>5.1 Verify that printer and paper take-up operate properly. Check printout for darkness, missing dots, etc.</p> <p>5.2 Verify that all touch panels function properly (O.E. & N.O.E).</p> <p>5.3 Verify that the date and time are correct. If not, correct.</p> <p>5.4 Verify operation of the battery backed RAM, replace as needed.</p> <p>5.5 Verify that the buzzer is working.</p> <p>5.6 Verify that the water level sensor operates properly.</p> <p>5.7 Verify that cooling fan operates properly.</p> <p>5.8 Replace fan filter.</p> <p>5.9 Check all service-settable values in Service Test Mode for factory recommended settings. Verify functional operation of each valve using the Service Test Mode.</p> <p>5.10 Verify temperature displays/printouts with potentiometer.</p> <p>5.9 Verify temperature and pressure settings as described in Maintenance Manual.</p>	<p>6x per year</p> <p>6x per year</p> <p>6x per year</p> <p>6x per year</p> <p>6x per year</p> <p>6x per year</p> <p>6x per year</p> <p>1x per year</p> <p>1x per year</p> <p>6x per year</p> <p>1x per year</p>

Table 11-1. Preventive Maintenance Schedule for Century Sterilizer (continued)

Service Required	Minimum Frequency
<p>6.0 SAFETY TESTING</p> <p>6.1 Inspect ground bond.</p> <p>6.2 Inspect steam connection to sterilizer.</p> <p>6.3 Inspect water connection to sterilizer.</p> <p>6.4 Inspect drain connection to sterilizer.</p> <p>6.5 Test ground continuity to sterilizer per EN 61010-1.</p>	<p>1x per year</p> <p>1x per year</p> <p>1x per year</p> <p>1x per year</p> <p>1x per year</p>
<p>7.0 FINAL CHECKOUT AND TEST</p> <p>7.1 Clean dirt and lint from components. Check all wiring, terminals and socket connections for damage or fraying.</p> <p>7.2 Verify that unit has proper labels (caution, warning).</p> <p>7.3 Run machine through each cycle to verify proper operation. Check all displays and printouts. Note on tape, "STERIS TEST".</p> <p>7.4 Verify that the shelves slide easily in and out of the chamber, if equipped.</p> <p>7.5 Reinstall any panel or cover removed. Check area to insure removal of all materials used during inspection.</p>	<p>6x per year</p> <p>6x per year</p> <p>6x per year</p> <p>6x per year</p>

11.2 Clean Chamber Drain Strainer

WARNING – BURN HAZARD: Failure to shut off the steam supply when cleaning or replacing strainers can result in serious injury.

WARNING – BURN HAZARD: Allow sterilizer to cool to room temperature before performing any cleaning or maintenance procedures.

IMPORTANT: The chamber drain strainer must be cleaned at least once a day, preferably in the morning before running the first cycle.

1. Remove the drain strainer from the drain in the bottom of the chamber as shown in Figure 11-1.
2. Remove any obvious debris from the strainer. If necessary, clear the screen in the strainer using a brush, wire or similar tool.
3. Once it has been cleared of obvious debris, reverse flush the strainer under running water.
4. Replace the strainer in the chamber drain.

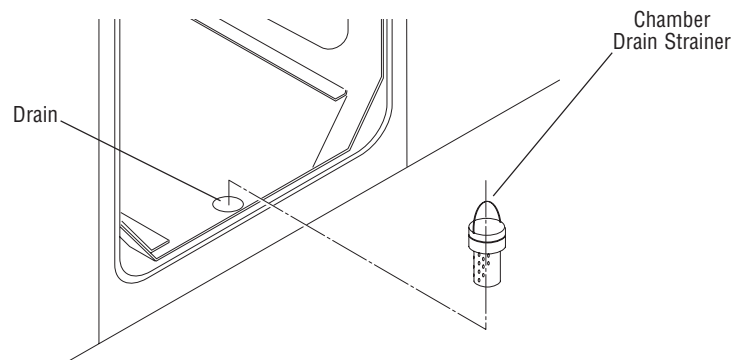

Figure 11-1. Remove Chamber Drain Strainer

11.3 Weekly Maintenance

11.3.1 Clean Chamber



WARNING - FALL HAZARD: To prevent falls, keep floors dry by immediately wiping up any spilled liquids or condensation in sterilizer loading and unloading areas.



WARNING - BURN HAZARD: Allow sterilizer to cool to room temperature before performing any cleaning or maintenance procedures.

IMPORTANT: The entire chamber should be wiped down and rinsed following any spills or other soiling.

1. If applicable, the shelf assembly must be removed before cleaning the chamber.

• Single Door

- a. Remove shelves from rack.
- b. Use a 1/8" hex wrench to loosen (but not remove) the set screws at the front of the rack assembly.
- c. Remove the rack assembly from the chamber.

• Double Door

- a. Remove shelves from rack.
- b. Use a 1/8" hex wrench to loosen (but not remove) the set screws at each end of the rack assembly.
- c. Remove the rack assembly from the chamber.

IMPORTANT: Chamber must be at room temperature, sterilizer off all night, before washing.

2. Wash the inside of the chamber and shelf assembly (plus any other loading equipment) with a mild detergent solution such as STERIS Liqui-Jet® or current STERIS equivalent. (Contact your local STERIS representative.)

11.3.2 Flush Chamber Drain



WARNING - BURN HAZARD: Allow sterilizer and accessories to cool to room temperature before performing any cleaning or maintenance procedures.

Flush chamber drain as follows whenever the line becomes clogged:

1. Turn off steam supply valve. Wait until jacket pressure is zero. Wait until chamber has cooled to room temperature.
2. Remove chamber drain strainer (Figure 11-1). Clean strainer using procedures given above, if necessary.
3. Pour a solution of 60 ml (~1/4 cup) of STERIS Sonic Detergent* or LiquiJet* and 500 ml (~1 pint) of hot water into the drain. Solution may puddle in the bottom of the chamber.

... OR ...

4. Should these detergents be unavailable, you may use a hot solution of 15ml (~1 tablespoon) of tri-sodium phosphate to 500 ml (~1 pint) of hot water.
5. Open door and place strainer back in drain.

* Contact your local STERIS representative.

11.3.3 Change Printer Paper Roll

The printer paper roll should be changed whenever a colored stripe is visible on one or both edges of the printout paper.

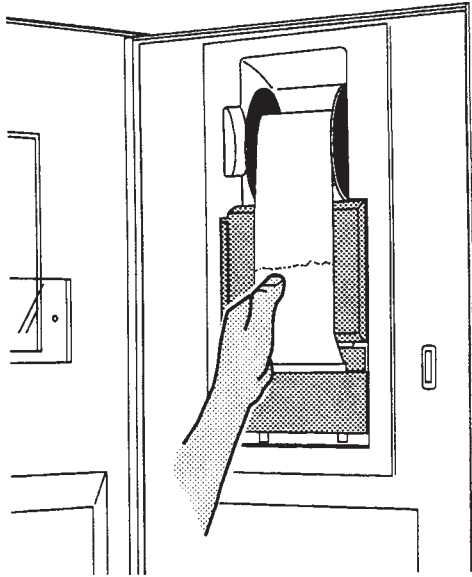

1. Tear paper between take-up spool and printer.

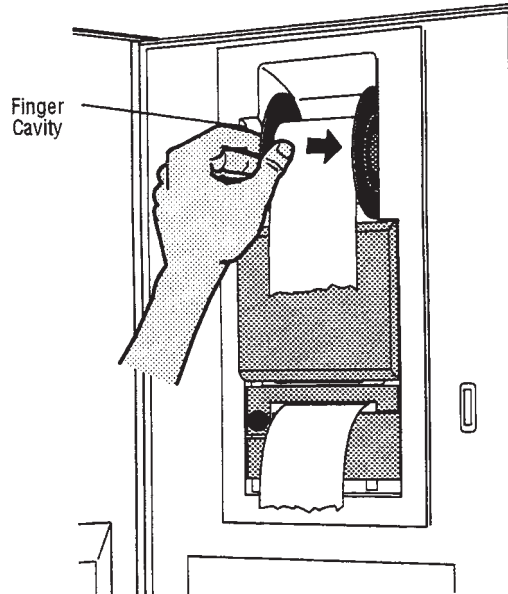

2. Remove take-up spool from drive by inserting fingers in cavity as shown and pushing spool to the right.

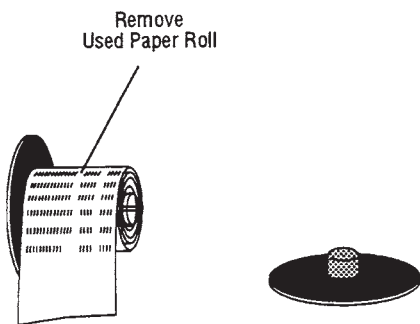

3. Pull off right end of spool and remove used paper roll from spindle.

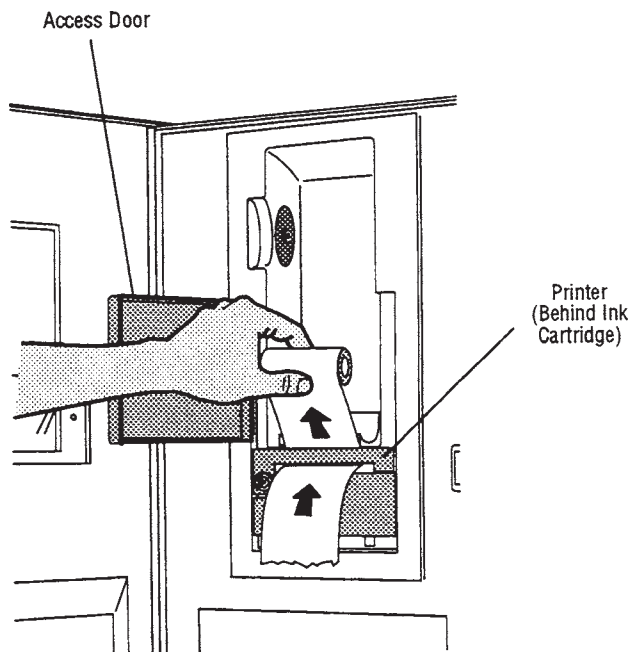

4. Open access door and remove old paper roll, **gently** pulling any remaining tape up and out of printer.

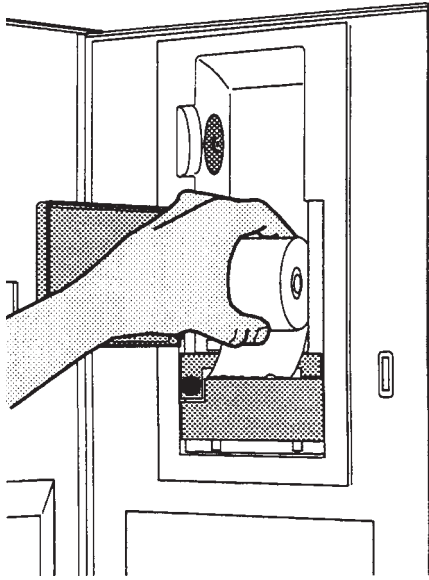

5. Insert new paper roll.

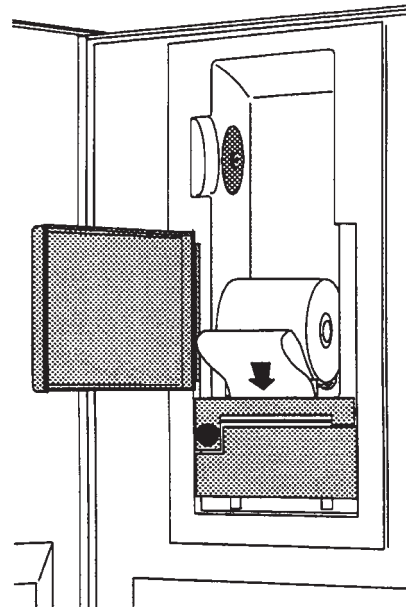

6. Insert end of paper into printer slot just behind ink cartridge.

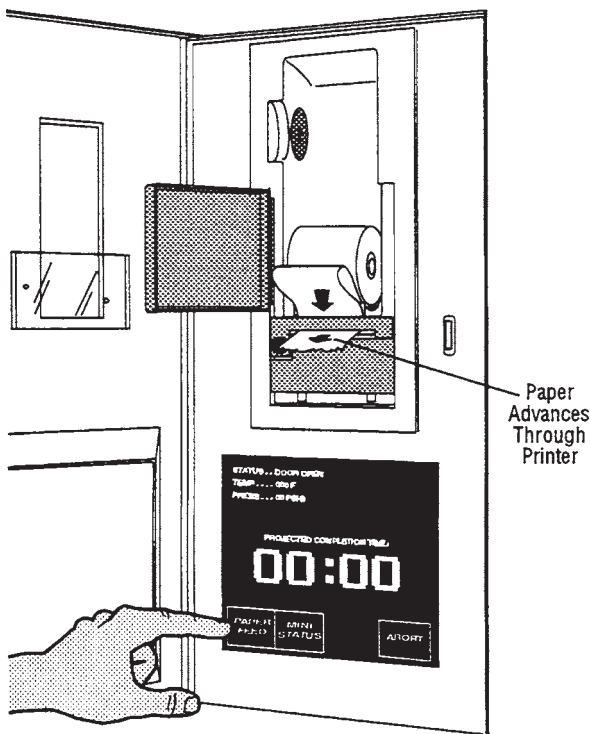

7. Press "PAPER FEED" touch screen pad on display until paper advances through printer and ink cartridge, exiting the front.

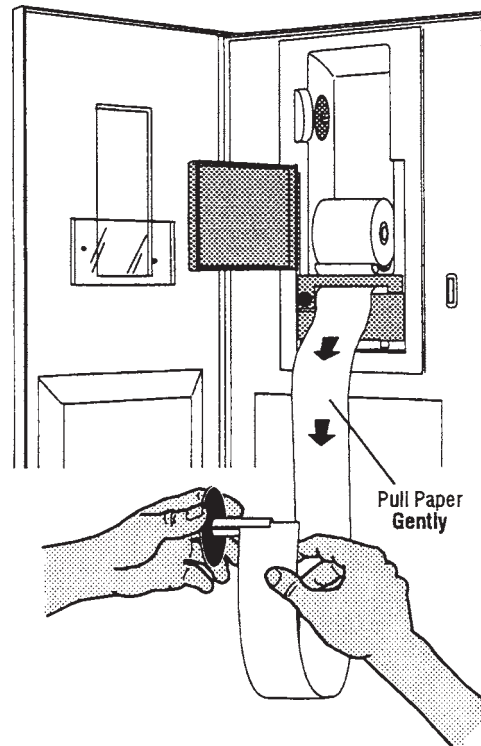

8. Continue pressing "PAPER FEED" (or pull paper **gently**) until about 46cm (18") of paper hangs out of printer. Insert end of paper into slot of take-up spool, then replace right end of spool.

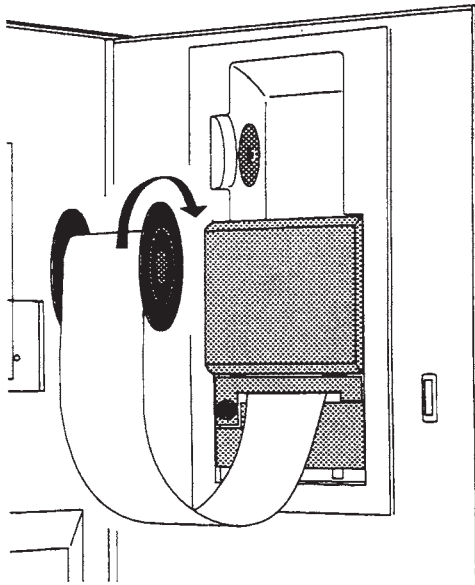

9. Rotate spool in direction shown until paper is secure.

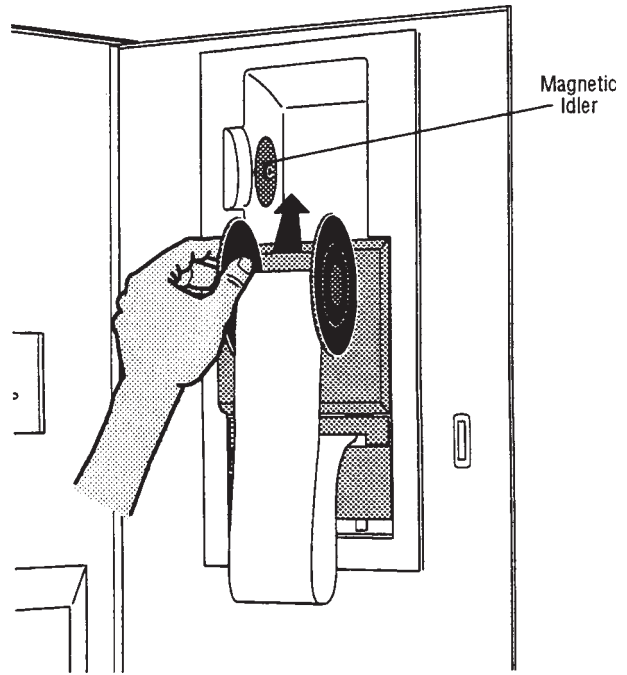

10. Reinstall take-up spool on magnetic idler. Manually roll up slack paper.

11.3.4 Change Printer Ink Cartridge

The printer ink cartridge should be changed as soon as the type on printouts is light or faded, and before printouts become difficult to read.

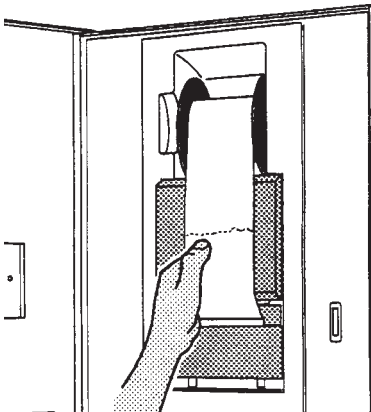

1. Tear paper between take-up spool and printer.

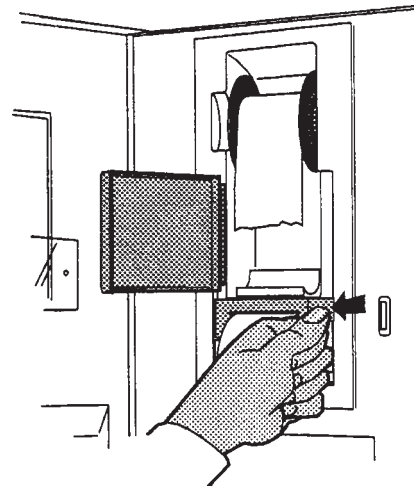

2. Open access door, then press on right end of ink cartridge, until left end of cartridge pops out of the printer.

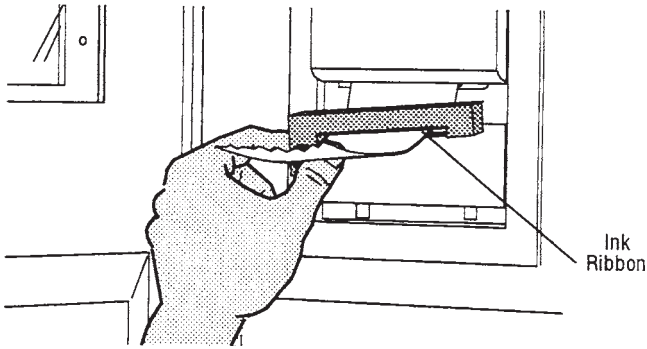

3. Slip cartridge off end of paper , slip new cartridge over paper in the same way as before, making sure paper slides between ink cartridge housing and ink ribbon.

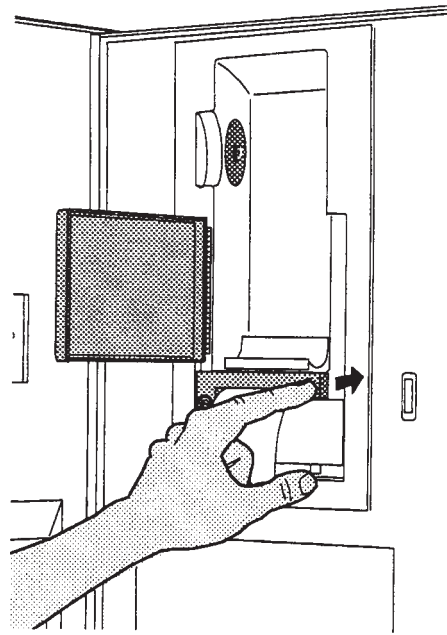

4. Install left end of cartridge first, then push right end in as shown, snapping it into place.

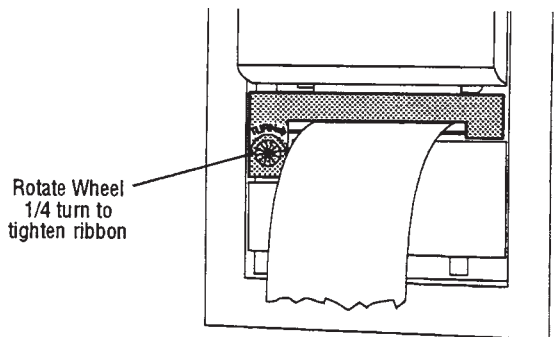

5. Retighten ribbon by rotating wheel on left side of cartridge 1/4 turn. Then see "Changing Paper Roll", steps 8 through 10 to reinstall take-up spool.

11.4 Replace Door Seal



WARNING - BURN HAZARD: Allow sterilizer to cool to room temperature before performing any cleaning or maintenance procedures.

This procedure should be performed by a qualified service technician. If door seal requires replacement, perform the following:

1. Allow sterilizer chamber and end frame to cool to room temperature.
2. Open sterilizer door.
3. Use flat tool with rounded edges (such as a non-serrated table knife) to pry and twist one section of the seal partially from the groove. Refer to Figure 11-2.
4. Grasp the raised section of the seal and pull the remainder from the end frame groove.
5. Examine the end frame groove for debris or residue. Clean if necessary.
6. Install new seal as follows:

NOTE: Ensure that lot data molded into rear of seal (refer to Figure 11-2) is at the bottom of the groove.

- **Do not** use a sharp instrument to install the seal.
- **Do not** stretch the seal.
- a. Align right and left reference indicators with drill point reference marks in seal groove, align top and bottom indicators with the drill point reference marks in seal groove.

NOTE: Reference indicators are located inside the rear groove of door seal, at the middle of each side (refer to Figure 11-2).

- b. Press seal in at each reference point with fingertips.
 - c. Press seal in at each corner with fingertips.
 - d. Press remainder of the seal into end frame groove.
7. Test installation.
 - a. Attempt to close the door. If the door sticks or will not fully close at any point in its travel, check to make sure the seal has been fully pressed into the groove.
 - b. Run a shortened test cycle to determine if the door seals adequately. If steam leaks from around the door or the seal, abort the cycle and examine the seal to ensure it has been properly seated in the end frame groove. Once re-seated, run another test cycle. If the door fails to seal following the second test, another problem may exist. Contact your supervisor before using the sterilizer.

At the end of the cycle, ensure seal has retracted fully into the groove.



WARNING – PERSONAL INJURY OR EQUIPMENT DAMAGE HAZARD: When closing the chamber door, keep hands and arms out of the door opening and make sure opening is clear of obstructions.

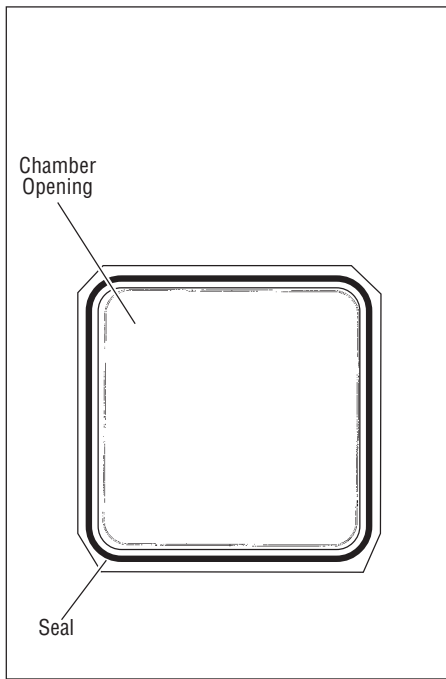
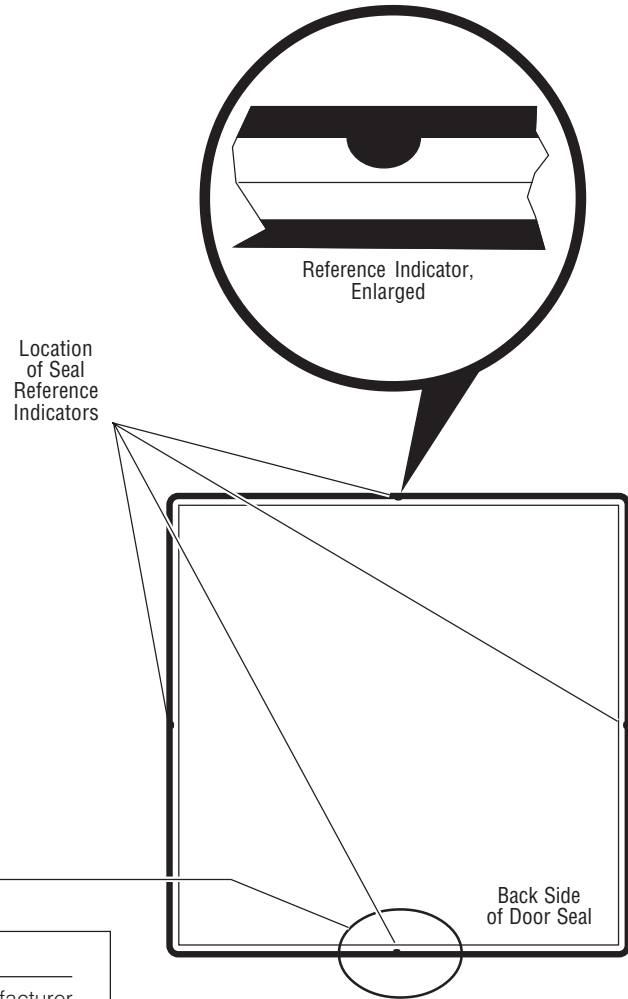

Figure 9-1. Remove Door Seal



The following lot data is molded into the back side of the seal:

P-129373-376	ABCDEFGHIJKLMN	1234	01	P
Part Number	Lot Index	Cure Quarter	Year	Manufacturer Code

The lot index and cure quarter are struck off during manufacturing. The first characters in sequence *not struck* are those used for identification. For example:

~~ABC~~DEFGHIJKLMN ~~1234~~ 01 P

The cure date is: 3rd Quarter, 2001. The lot is: 01C.

Figure 11-2. Location of Seal Lot Data and Reference Indicators

12.1 General

WARNING – PERSONAL INJURY AND/OR EQUIPMENT DAMAGE HAZARD: Repairs and adjustments to this equipment must be made only by fully qualified service personnel. Maintenance performed by inexperienced, unqualified persons or installation of unauthorized parts could cause personal injury or result in costly equipment damage.

WARNING–SHOCK HAZARD: Disconnect all utilities to sterilizer before servicing. See Section 1 for expanded warning.

WARNING–BURN HAZARD: Allow sterilizer to cool to room temperature before performing any cleaning or maintenance procedures.

This section pictorially lists and describes all the possible alarm conditions which may occur when operating the Amsco® Century Medium Steam Sterilizer 26 x 26" (660 x 660 mm).

If a problem occurs that is not described in this section, please call your STERIS Service representative. A trained service technician will promptly place your sterilizer in proper working condition.

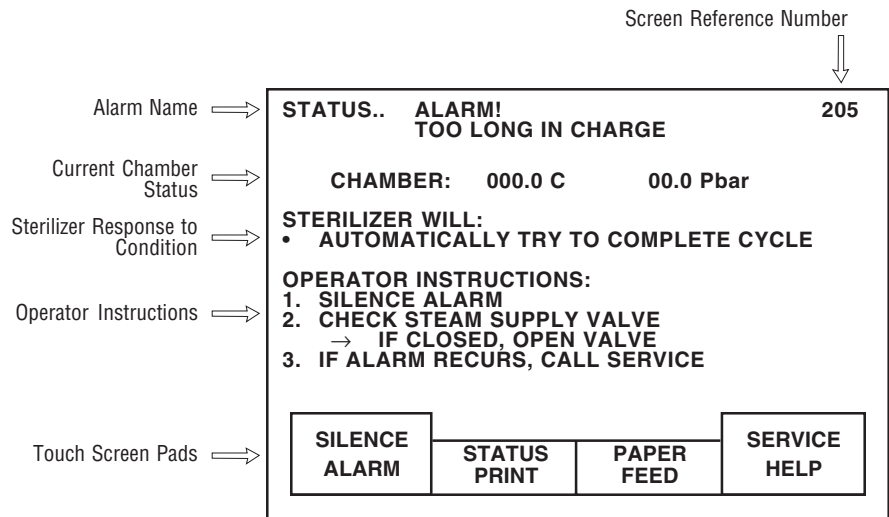

Figure 12-1. Typical Alarm Screen

12.1.1 Typical Alarm Screen

NOTE: Never permit unqualified persons to service the sterilizer.

When an alarm condition occurs, the alarm tone sounds and the touch screen automatically displays the corresponding alarm screen. Typically, each alarm screen indicates the alarm name, current chamber status, current sterilizer activity and operator instructions (see Figure 12-1).

Touch screen pads, located along bottom of alarm screen, are used to perform the following functions.

- Pressing **SILENCE ALARM** turns off the alarm tone.
- Pressing **STATUS PRINT** generates a printout of the current temperature and pressure in the sterilizer chamber at the time the touch pad was pressed.
- Pressing **PAPER FEED** advances the printer paper up by one line.
- Pressing **SERVICE HELP** advances display to the corresponding service information screen. This screen provides the qualified service technician with possible causes and advanced corrective actions for that alarm

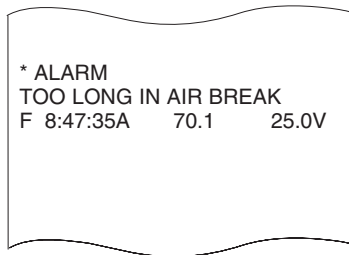

Full Print Format Shown

Figure 12-2. Typical Alarm Printout

condition.

IMPORTANT: In the event of an alarm condition, the operator should always follow the instructions indicated on the alarm screen.

When an alarm occurs the printer automatically generates a printout, typically listing alarm name, time alarm occurred, current chamber status and any associated sensor temperature. See Figure 12-2.

12.1.2 Typical Alarm Printout

12.2 In-Cycle Alarms

Alarm	Description	Screen with Operator Instructions
<p>12.2.1 Too Long In Charge</p>	<p>The following alarm screens will appear only during cycle operation.</p> <p>Occurs if chamber does</p>	<div style="border: 1px solid black; padding: 5px;"> <p>STATUS.. ALARM! 205 TOO LONG IN CHARGE</p> <p>CHAMBER: 000.0 C 0.00 Pbar</p> <p>STERILIZER WILL:</p> <ul style="list-style-type: none"> • AUTOMATICALLY TRY TO COMPLETE CYCLE <p>OPERATOR INSTRUCTIONS:</p> <ol style="list-style-type: none"> 1. SILENCE ALARM 2. CHECK STEAM SUPPLY VALVE → IF CLOSED, OPEN VALVE 3. IF ALARM RECURS, CALL SERVICE <div style="display: flex; justify-content: space-around; margin-top: 10px;"> <div style="border: 1px solid black; padding: 2px 5px;">SILENCE ALARM</div> <div style="border: 1px solid black; padding: 2px 5px;">STATUS PRINT</div> <div style="border: 1px solid black; padding: 2px 5px;">PAPER FEED</div> <div style="border: 1px solid black; padding: 2px 5px;">SERVICE HELP</div> </div> </div> <div style="border: 1px solid black; padding: 5px; margin-top: 5px;"> <p style="text-align: center;">Screen with Service Instructions</p> <div style="border: 1px solid black; padding: 5px;"> <p>STATUS.. SERVICE INFORMATION: 206 TOO LONG IN CHARGE</p> <p>→ CHAMBER DID NOT REACH STERILIZE TEMPERATURE WITHIN ALLOTTED TIME</p> <p>CAUSES AND CORRECTION:</p> <ol style="list-style-type: none"> 1. STEAM PRESSURE LESS THAN 3.45 Pbar → CHECK STEAM SUPPLY PIPING 2. STEAM REGULATOR MALFUNCTION → REPAIR 3. SOLENOID VALVE MALFUNCTION → REPAIR S09 → REPAIR S02 4. CONTROL OUT OF CALIBRATION → RECALIBRATE (CONTACT QUALIFIED SERVICE PERSON) <div style="display: flex; justify-content: space-around; margin-top: 10px;"> <div style="border: 1px solid black; padding: 2px 5px;">SERVICE MODE</div> <div style="border: 1px solid black; padding: 2px 5px;">ABORT</div> <div style="border: 1px solid black; padding: 2px 5px;">EXIT</div> </div> </div> </div>

Alarm	Description	Screen with Operator Instructions
<p>12.2.2 Too Long In Exhaust</p>	<p>not reach the set temperature within the allotted time.</p>	<div style="border: 1px solid black; padding: 5px;"> <p>STATUS.. ALARM! TOO LONG IN EXHAUST 200</p> <p>CHAMBER: 000.0 C 0.00 Pbar</p> <p>STERILIZER WILL:</p> <ul style="list-style-type: none"> • AUTOMATICALLY TRY TO COMPLETE CYCLE • EXTENDEXHAUST TIME <p>OPERATOR INSTRUCTIONS:</p> <ol style="list-style-type: none"> 1. SILENCE ALARM 2. IF ALARM RECURS, CALL SERVICE <div style="display: flex; justify-content: space-around; margin-top: 10px;"> <div style="border: 1px solid black; padding: 2px 5px;">SILENCE ALARM</div> <div style="border: 1px solid black; padding: 2px 5px;">STATUS PRINT</div> <div style="border: 1px solid black; padding: 2px 5px;">PAPER FEED</div> <div style="border: 1px solid black; padding: 2px 5px;">SERVICE HELP</div> </div> </div> <hr/> <div style="border: 1px solid black; padding: 5px;"> <p style="text-align: center;">Screen with Service Instructions</p> </div> <hr/> <div style="border: 1px solid black; padding: 5px;"> <p>STATUS.. SERVICE INFORMATION: TOO LONG IN EXHAUST 201</p> <p>→ CHAMBER DID NOT EXHAUST TO ATMOSPHERIC PRESSURE WITHIN ALLOTTED TIME</p> <p>CAUSES AND CORRECTION:</p> <ol style="list-style-type: none"> 1. CHAMBER DRAIN STRAINER PLUGGED → CLEAN 2. SOLENOID VALVE MALFUNCTION → REPAIR S03 3. CONTROL OUT OF CALIBRATION → RECALIBRATE (CONTACT QUALIFIED SERVICE PERSON) <div style="display: flex; justify-content: space-around; margin-top: 10px;"> <div style="border: 1px solid black; padding: 2px 5px;">PAPER FEED</div> <div style="border: 1px solid black; padding: 2px 5px;">EXIT</div> </div> </div>
<p>12.2.3 Too Long In Evacuation</p>	<p>Occurs if chamber does not exhaust to 0.28 Vbar (4 psig) within the allotted time.</p>	<div style="border: 1px solid black; padding: 5px;"> <p style="text-align: center;">Screen with Operator Instructions</p> </div> <hr/> <div style="border: 1px solid black; padding: 5px;"> <p>STATUS.. ALARM! TOO LONG IN EVACUATION 202</p> <p>CHAMBER: 000.0 C 0.00 Pbar</p> <p>STERILIZER WILL:</p> <ul style="list-style-type: none"> • AUTOMATICALLY TRY TO COMPLETE CYCLE <p>OPERATOR INSTRUCTIONS:</p> <ol style="list-style-type: none"> 1. SILENCE ALARM 2. CHECK WATER SUPPLY VALVE → IF CLOSED, OPEN VALVE 3. IF ALARM RECURS, ABORT CYCLE AND CALL SERVICE <div style="display: flex; justify-content: space-around; margin-top: 10px;"> <div style="border: 1px solid black; padding: 2px 5px;">SILENCE ALARM</div> <div style="border: 1px solid black; padding: 2px 5px;">ABORT</div> <div style="border: 1px solid black; padding: 2px 5px;">SERVICE HELP</div> </div> </div>

Alarm	Description	Screen with Service Instructions				
<p>12.2.3 Too Long In Evacuation, Continued</p>	<p><i>NOTE: This alarm has two service help screens.</i></p>	<p>STATUS.. SERVICE INFORMATION: 203 TOO LONG IN EVACUATION</p> <p>→ CHAMBER DID NOT REACH REQUIRED VACUUM LEVEL WITHIN ALLOTTED TIME</p> <p>CAUSES AND CORRECTION:</p> <ol style="list-style-type: none"> 1. WATER PRESSURE LESS THAN 2.07 Pbar → CHECK WATER SUPPLY PIPING 2. CHAMBER DRAIN STRAINER PLUGGED → CLEAN 3. CHECK VALVE MALFUNCTION → REPAIR 4. SOLENOID VALVE MALFUNCTION → REPAIR 5. DOOR SEAL NOT ACTIVATED → CHECK SEAL → CHECK SEAL STEAM AND EXHAUST <table border="1" data-bbox="857 604 1432 667"> <tr> <td>EXIT</td> <td>STATUS PRINT</td> <td>PAPER FEED</td> <td>MORE HELP</td> </tr> </table>	EXIT	STATUS PRINT	PAPER FEED	MORE HELP
		EXIT	STATUS PRINT	PAPER FEED	MORE HELP	
<p>STATUS.. SERVICE INFORMATION: 204 TOO LONG IN EVACUATION</p> <p>→ CHAMBER DID NOT REACH REQUIRED VACUUM LEVEL WITHIN ALLOTTED TIME</p> <p>CAUSES AND CORRECTION:</p> <ol style="list-style-type: none"> 6. LEAK IN PLUMBING → REPAIR → RUN A LEAK TEST 7. CONTROL OUT OF CALIBRATION → RECALIBRATE CONTROL (CONTACT QUALIFIED SERVICE PERSON) <table border="1" data-bbox="862 1060 1432 1123"> <tr> <td>PAPER FEED</td> <td>EXIT</td> </tr> </table>	PAPER FEED	EXIT				
PAPER FEED	EXIT					
<p>12.2.4 Too Long In Air Break</p>	<p>Occurs if chamber does not reach the set evacuation level within the allotted time.</p>	<p align="center">Screen with Operator Instructions</p> <p>STATUS.. ALARM! 225 TOO LONG IN AIR BREAK</p> <p align="center">CHAMBER: 000.0 C 0.00 Pbar</p> <p>STERILIZER WILL:</p> <ul style="list-style-type: none"> • AUTOMATICALLY TRY TO COMPLETE CYCLE • EXTEND AIR BREAK TIME <p>OPERATOR INSTRUCTIONS:</p> <ol style="list-style-type: none"> 1. SILENCE ALARM 2. IF ALARM RECURS, CALL SERVICE <table border="1" data-bbox="857 1579 1432 1663"> <tr> <td>SILENCE ALARM</td> <td>STATUS PRINT</td> <td>PAPER FEED</td> <td>SERVICE HELP</td> </tr> </table>	SILENCE ALARM	STATUS PRINT	PAPER FEED	SERVICE HELP
SILENCE ALARM	STATUS PRINT	PAPER FEED	SERVICE HELP			

Alarm	Description	Screen with Service Instructions
<p>Too Long In Air Break, Continued</p>		<div style="border: 1px solid black; padding: 5px;"> <p style="text-align: right;">226</p> <p>STATUS.. SERVICE INFORMATION: TOO LONG IN AIR BREAK</p> <p>→ CHAMBER DID NOT AIR BREAK VACUUM TO 0.07 Vbar WITHIN ALLOTTED TIME</p> <p>CAUSES AND CORRECTION:</p> <ol style="list-style-type: none"> 1. AIR INLET FILTER PLUGGED → REPLACE 2. SOLENOID VALVE MALFUNCTION → REPAIR S01 3. CONTROL OUT OF CALIBRATION → RECALIBRATE (CONTACT QUALIFIED SERVICE PERSON) <div style="display: flex; justify-content: space-between; margin-top: 10px;"> <div style="border: 1px solid black; padding: 2px 5px;">PAPER FEED</div> <div style="border: 1px solid black; padding: 2px 5px;">EXIT</div> </div> </div>
<p>12.2.5 Under Sterilize Temperature</p>	<p>Occurs if chamber does not air break the vacuum to 0.07 Vbar (2 inHg) within the allotted</p>	<div style="border: 1px solid black; padding: 5px;"> <p style="text-align: center;">Screen with Operator Instructions</p> <hr/> <p style="text-align: right;">223</p> <p>STATUS.. ALARM! UNDER STERILIZE TEMPERATURE</p> <p>CHAMBER: 000.0 C 0.00 Pbar</p> <p>STERILIZER WILL:</p> <ul style="list-style-type: none"> • AUTOMATICALLY RESTART STERILIZE TIME AND CONTINUE CYCLE AFTER SET TEMP. IS REACHED <p>OPERATOR INSTRUCTIONS:</p> <ol style="list-style-type: none"> 1. SILENCE ALARM 2. IF ALARM RECURS, CALL SERVICE <div style="display: flex; justify-content: space-around; margin-top: 10px;"> <div style="border: 1px solid black; padding: 2px 5px;">SILENCE ALARM</div> <div style="border: 1px solid black; padding: 2px 5px;">STATUS PRINT</div> <div style="border: 1px solid black; padding: 2px 5px;">PAPER FEED</div> <div style="border: 1px solid black; padding: 2px 5px;">SERVICE HELP</div> </div> </div>
	<p><i>NOTE: If under temperature value is set to "RESUME", the sterilizer will automatically resume sterilize time after set temperature is reached.</i></p>	<div style="border: 1px solid black; padding: 5px;"> <p style="text-align: center;">Screen with Service Instructions</p> <hr/> <p style="text-align: right;">224</p> <p>STATUS.. SERVICE INFORMATION: UNDER STERILIZE TEMPERATURE</p> <p>→ CHAMBER TEMPERATURE DROPPED BELOW STERILIZE TEMPERATURE BY UNDERTEMP TEMPERATURE VALUE</p> <p>CAUSES AND CORRECTION:</p> <ol style="list-style-type: none"> 1. STEAM PRESSURE LESS THAN 3.45 Pbar → CHECK STEAM SUPPLY PIPING 2. CHAMBER STEAM TRAP MALFUNCTION → REPAIR 3. SOLENOID VALVE MALFUNCTION → REPAIR S09 → REPAIR S02 4. CONTROL OUT OF CALIBRATION → RECALIBRATE (CONTACT QUALIFIED SERVICE PERSON) <div style="display: flex; justify-content: space-between; margin-top: 10px;"> <div style="border: 1px solid black; padding: 2px 5px;">PAPER FEED</div> <div style="border: 1px solid black; padding: 2px 5px;">EXIT</div> </div> </div>

Alarm	Description	Screen with Operator Instructions
<p>12.2.6 Over Sterilize Temperature</p>	<p>time. Occurs if chamber temperature drops below sterilize temperature.</p>	<div data-bbox="833 222 1456 651" style="border: 1px solid black; padding: 5px;"> <p>STATUS.. ALARM! OVER STERILIZE TEMPERATURE 235</p> <p>CHAMBER: 000.0 C 0.00 Pbar</p> <p>STERILIZER WILL:</p> <ul style="list-style-type: none"> • AUTOMATICALLY CONTINUE CYCLE <p>OPERATOR INSTRUCTIONS:</p> <ol style="list-style-type: none"> 1. SILENCE ALARM 2. IF ALARM RECURS, ABORT CYCLE AND CALL SERVICE <div style="display: flex; justify-content: space-around; margin-top: 10px;"> <div data-bbox="857 546 998 630" style="border: 1px solid black; padding: 5px; text-align: center;">SILENCE ALARM</div> <div data-bbox="1063 567 1226 630" style="border: 1px solid black; padding: 5px; text-align: center;">ABORT</div> <div data-bbox="1282 546 1429 630" style="border: 1px solid black; padding: 5px; text-align: center;">SERVICE HELP</div> </div> </div> <hr/> <div data-bbox="833 703 1456 1218" style="border: 1px solid black; padding: 5px;"> <p style="text-align: center;">Screen with Service Instructions</p> <hr/> <div data-bbox="833 777 1456 1207" style="border: 1px solid black; padding: 5px;"> <p>STATUS.. SERVICE INFORMATION: OVER STERILIZE TEMPERATURE 236</p> <p>→ STERILIZE TEMPERATURE IS ABOVE SETPOINT BY MORE THAN PRESCRIBED AMOUNT</p> <p>CAUSES AND CORRECTION:</p> <ol style="list-style-type: none"> 1. STEAM PRESSURE MORE THAN 3.45 Pbar → CHECK STEAM SUPPLY PIPING 2. CHAMBER STEAM TRAP MALFUNCTION → REPAIR 3. SOLENOID VALVE MALFUNCTION → REPAIR S09 → REPAIR S02 4. CONTROL OUT OF CALIBRATION → RECALIBRATE (CONTACT QUALIFIED SERVICE PERSON) <div style="display: flex; justify-content: space-between; margin-top: 10px;"> <div data-bbox="857 1144 998 1207" style="border: 1px solid black; padding: 2px;">SERVICE MODE</div> <div data-bbox="998 1144 1144 1207" style="border: 1px solid black; padding: 2px;">STATUS PRINT</div> <div data-bbox="1144 1144 1291 1207" style="border: 1px solid black; padding: 2px;">PAPER FEED</div> <div data-bbox="1291 1144 1429 1207" style="border: 1px solid black; padding: 2px;">EXIT</div> </div> </div> </div>

Alarm	Description	Screen with Operator Instructions
12.2.7 Door Unsealed	Occurs if chamber temperature exceeds the maximum sterilize temperature (control temp. plus over temp. value).	<div style="border: 1px solid black; padding: 5px;"> <p>STATUS.. ALARM! DOOR UNSEALED 207</p> <p>CHAMBER: 000.0 C 0.0Pbar</p> <p>STERILIZER WILL:</p> <ul style="list-style-type: none"> • AUTOMATICALLY ABORT CYCLE • EXHAUST OR AIR BREAK CHAMBER TO ATMOSPHERIC PRESSURE <p>OPERATOR INSTRUCTIONS:</p> <ol style="list-style-type: none"> 1. SILENCE ALARM 2. CALL SERVICE <div style="display: flex; justify-content: space-around; margin-top: 10px;"> <div style="border: 1px solid black; padding: 2px 5px;">SILENCE ALARM</div> <div style="border: 1px solid black; padding: 2px 5px;">STATUS PRINT</div> <div style="border: 1px solid black; padding: 2px 5px;">PAPER FEED</div> <div style="border: 1px solid black; padding: 2px 5px;">SERVICE HELP</div> </div> </div>
		Screen with Service Instructions
		<div style="border: 1px solid black; padding: 5px;"> <p>STATUS.. SERVICE INFORMATION: DOOR UNSEALED 208</p> <p>→ STEAM PRESSURE IN DOOR SEAL BELOW 0.69 pbar</p> <p>CAUSES AND CORRECTION:</p> <ol style="list-style-type: none"> 1. SEAL PRESSURE SWITCH MALFUNCTION <ul style="list-style-type: none"> → CHECK PS1(P2) CONNECTIONS → REPAIR PS1(P2) 2. SEAL NOT ACTIVATED <ul style="list-style-type: none"> → CHECK SEAL STEAM → CHECK SEAL EXHAUST 3. SOLENOID VALVE MALFUNCTION <ul style="list-style-type: none"> → REPAIR S35(S36) <div style="display: flex; justify-content: space-around; margin-top: 10px;"> <div style="border: 1px solid black; padding: 2px 5px;">PAPER FEED</div> <div style="border: 1px solid black; padding: 2px 5px;">CLEAR ALARM</div> <div style="border: 1px solid black; padding: 2px 5px;">EXIT</div> </div> </div>
12.2.8 Chamber Pressure/Temperature Failure	Occurs if steam pressure in door seal drops below 0.35 Pbar (5 psig). Occurs if chamber pressure or temperature readings are outside the normal steam range during sterilize phase.	<div style="border: 1px solid black; padding: 5px;"> <p style="text-align: center;">Screen with Operator Instructions</p> <hr/> <p>STATUS.. ALARM! CHAMBER PRESSURE/TEMPERATURE FAILURE 219</p> <p>CHAMBER: 000.0 C 0.00 Pbar</p> <p>STERILIZER WILL:</p> <ul style="list-style-type: none"> • AUTOMATICALLY ABORT CYCLE <p>OPERATOR INSTRUCTIONS:</p> <ol style="list-style-type: none"> 1. SILENCE ALARM 2. CALL SERVICE <div style="display: flex; justify-content: space-around; margin-top: 10px;"> <div style="border: 1px solid black; padding: 2px 5px;">SILENCE ALARM</div> <div style="border: 1px solid black; padding: 2px 5px;">STATUS PRINT</div> <div style="border: 1px solid black; padding: 2px 5px;">PAPER FEED</div> <div style="border: 1px solid black; padding: 2px 5px;">SERVICE HELP</div> </div> </div>

Alarm	Description	Screen with Service Instructions
<p>Chamber Pressure/ Temperature Failure, Continued</p>		<div style="border: 1px solid black; padding: 5px;"> <p>STATUS.. SERVICE INFO: CHAMBER 220 PRESSURE/TEMPERATURE FAILURE</p> <p>→ PRESSURE OR TEMPERATURE OUTSIDE NORMAL STEAM RANGE</p> <p>CAUSES AND CORRECTION:</p> <ol style="list-style-type: none"> 1. CONTROL OUT OF CALIBRATION → RECALIBRATE (CONTACT QUALIFIED SERVICE PERSON) 2. TRANSDUCER, CP, MALFUNCTION → REPAIR 3. RTD PROBE, CT, MALFUNCTION → REPAIR 4. MAIN CONTROL FAILURE → CHECK CONTROL BOARD POWER STATUS LEDs → REPLACE CONTROL BOARD → RECALIBRATE <div style="display: flex; justify-content: space-around; margin-top: 10px;"> <div style="border: 1px solid black; padding: 2px 5px;">PAPER FEED</div> <div style="border: 1px solid black; padding: 2px 5px;">SERVICE MODE</div> <div style="border: 1px solid black; padding: 2px 5px;">EXIT</div> </div> </div>

12.3 Out-of-Cycle Alarms

The following alarm screens will appear only when the sterilizer is not processing a cycle.

Alarm	Description	Screen with Operator Instructions							
<p>12.3.1 Too Long To Close Door</p>	<p>Occurs if door switch does not make contact within allotted time.</p>	<div data-bbox="862 373 1479 800"> <p>STATUS.. ALARM! 239 TOO LONG TO CLOSE DOOR CHAMBER: 000.0 C 0.00 Pbar</p> <p>STERILIZER WILL:</p> <ul style="list-style-type: none"> REMAIN IN ALARM CONDITION UNTIL DOOR IS CLOSED <p>OPERATOR INSTRUCTIONS:</p> <ol style="list-style-type: none"> SILENCE ALARM CHECK DOOR FOR OBSTRUCTION → REMOVE OBSTRUCTION AND CLOSE DOOR IF DOOR WILL NOT CLOSE, CALL SERVICE <table border="1" data-bbox="881 695 1446 774"> <tr> <td>SILENCE ALARM</td> <td>STATUS PRINT</td> <td>PAPER FEED</td> <td>SERVICE HELP</td> </tr> </table> </div> <hr/> <p style="text-align: center;">Screen with Service Instructions</p> <hr/> <div data-bbox="862 905 1479 1331"> <p>STATUS.. SERVICE INFORMATION: 240 TOO LONG TO CLOSE DOOR</p> <p>→ DOOR SWITCH DID NOT MAKE IN ALLOTTED TIME</p> <p>CAUSES AND CORRECTION:</p> <ol style="list-style-type: none"> DOOR SWITCH MALFUNCTION <ul style="list-style-type: none"> → CHECK LS1(LS2) CONNECTIONS → READJUST LS1(LS2) → REPAIR LS1(LS2) POWER DOOR MECHANISM FAILURE <ul style="list-style-type: none"> → REPAIR MECHANISM → REPLACE MOTOR <table border="1" data-bbox="889 1262 1458 1314"> <tr> <td>PAPER FEED</td> <td>CLEAR ALARM</td> <td>EXIT</td> </tr> </table> </div>	SILENCE ALARM	STATUS PRINT	PAPER FEED	SERVICE HELP	PAPER FEED	CLEAR ALARM	EXIT
SILENCE ALARM	STATUS PRINT	PAPER FEED	SERVICE HELP						
PAPER FEED	CLEAR ALARM	EXIT							

Alarm	Description	Screen with Operator Instructions
<p>12.3.2 Too Long To Open Door</p>	<p>Occurs if door switch does not open within the allotted time.</p>	<div style="border: 1px solid black; padding: 5px;"> <p>STATUS.. ALARM! TOO LONG TO OPEN DOOR 245</p> <p>CHAMBER: 000.0 C 0.00 pBAR</p> <p>STERILIZER WILL:</p> <ul style="list-style-type: none"> • REMAIN IN ALARM CONDITION UNTIL DOOR IS OPENED <p>OPERATOR INSTRUCTIONS:</p> <ol style="list-style-type: none"> 1. SILENCE ALARM 2. CALL SERVICE <div style="display: flex; justify-content: space-around; margin-top: 10px;"> <div style="border: 1px solid black; padding: 2px 5px;">SILENCE ALARM</div> <div style="border: 1px solid black; padding: 2px 5px;">STATUS PRINT</div> <div style="border: 1px solid black; padding: 2px 5px;">PAPER FEED</div> <div style="border: 1px solid black; padding: 2px 5px;">SERVICE HELP</div> </div> </div> <hr/> <p style="text-align: center;">Screen with Service Instructions</p> <hr/> <div style="border: 1px solid black; padding: 5px;"> <p>STATUS.. SERVICE INFORMATION: TOO LONG TO OPEN DOOR 246</p> <p>→ DOOR SWITCH DID NOT OPEN IN ALLOTTED TIME</p> <p>CAUSES AND CORRECTION:</p> <ol style="list-style-type: none"> 1. DOOR SWITCH MALFUNCTION <ul style="list-style-type: none"> → CHECK LS1(LS2) CONNECTIONS → READJUST LS1(LS2) 2. POSER DOOR MECHANISM FAILURE <ul style="list-style-type: none"> → REPAIR MECHANISM → REPLACE MOTOR <div style="display: flex; justify-content: space-around; margin-top: 10px;"> <div style="border: 1px solid black; padding: 2px 5px;">PAPER FEED</div> <div style="border: 1px solid black; padding: 2px 5px;">CLEAR ALARM</div> <div style="border: 1px solid black; padding: 2px 5px;">EXIT</div> </div> </div>
<p>12.3.3 Pressure In Chamber</p>	<p>Occurs if 0.14 Pbar (2 psig) pressure is sensed in the chamber.</p>	<div style="border: 1px solid black; padding: 5px;"> <p style="text-align: center;">Screen with Operator Instructions</p> <hr/> <p>STATUS.. ALARM! PRESSURE IN CHAMBER 221</p> <p>CHAMBER: 000.0 C 0.00 Pbar</p> <p>STERILIZER WILL:</p> <ul style="list-style-type: none"> • AUTOMATICALLY EXHAUST CHAMBER TO ATMOSPHERIC PRESSURE <p>OPERATOR INSTRUCTIONS:</p> <ol style="list-style-type: none"> 1. SILENCE ALARM 2. IF ALARM RECURS, CALL SERVICE <div style="display: flex; justify-content: space-around; margin-top: 10px;"> <div style="border: 1px solid black; padding: 2px 5px;">SILENCE ALARM</div> <div style="border: 1px solid black; padding: 2px 5px;">STATUS PRINT</div> <div style="border: 1px solid black; padding: 2px 5px;">PAPER FEED</div> <div style="border: 1px solid black; padding: 2px 5px;">SERVICE HELP</div> </div> </div>

Alarm	Description	Screen with Service Instructions
<p>Pressure In Chamber, Continued</p>		<div style="border: 1px solid black; padding: 5px;"> <p>STATUS.. SERVICE INFORMATION: 222 PRESSURE IN CHAMBER</p> <p>→ 0.14 PBAR PRESSURE SENSED IN CHAMBER WHEN NOT IN CYCLE</p> <p>CAUSES AND CORRECTION:</p> <ol style="list-style-type: none"> 1. SOLENOID VALVE MALFUNCTION → REPAIR S02 2. CONTROL OUT OF CALIBRATION → RECALIBRATE (CONTACT QUALIFIED SERVICE PERSON) 3. TRANSDUCER, CP, MALFUNCTION → REPAIR → RECALIBRATE 4. MAIN CONTROL FAILURE → CHECK CONTROL BOARD POWER STATUS LEDs → REPLACE 146659-065 CONTROL BOARD → RECALIBRATE <div style="display: flex; justify-content: space-between; margin-top: 10px;"> PAPER FEED EXIT </div> </div>
<p>12.3.4 Waste Temperature Probe Failure</p>	<p>Occurs if wasteline temperature reading is outside the normal range.</p>	<div style="border: 1px solid black; padding: 5px; margin-bottom: 10px;"> <p style="text-align: center;">Screen with Service Instructions</p> <hr/> <p>STATUS.. ALARM! WASTE 215 TEMPERATURE PROBE FAILURE</p> <p>CHAMBER: 000.0 C 0.00 Pbar WASTE: 000.0 C</p> <p>STERILIZER WILL:</p> <ul style="list-style-type: none"> • PREVENT NEW CYCLE FROM BEING STARTED UNTIL ALARM IS CLEARED <p>OPERATOR INSTRUCTIONS:</p> <ol style="list-style-type: none"> 1. SILENCE ALARM 2. CALL SERVICE <div style="display: flex; justify-content: space-around; margin-top: 10px;"> SILENCE ALARM STATUS PRINT PAPER FEED SERVICE HELP </div> </div> <div style="border: 1px solid black; padding: 5px;"> <p style="text-align: center;">Screen with Service Instructions</p> <hr/> <p>STATUS.. SERVICE INFORMATION: 216 WASTE TEMP PROBE FAILURE</p> <p>→ RTD PROBE, WT, OUTPUT IS OUTSIDE NORMAL RANGE</p> <p>CAUSES AND CORRECTION:</p> <ol style="list-style-type: none"> 1. LOOSE CONNECTION IN PROBE WIRING → REPAIR 2. PROBE FAILED → REPLACE → RECALIBRATE 3. CONTROL OUT OF CALIBRATION → RECALIBRATE (CONTACT QUALIFIED SERVICE PERSONNEL) 4. MAIN CONTROL FAILURE → CHECK CONTROL BOARD POWER STATUS LEDs → REPLACE 146659-065 CONTROL BOARD <div style="display: flex; justify-content: space-between; margin-top: 10px;"> PAPER EXIT </div> </div>

12.4 Sensor Alarms

The following alarm screens will appear any time the sterilizer is energized. The sensors are continually monitored whenever the sterilizer is in or out of cycle.

Alarm	Description	Screen with Operator Instructions
<p>12.4.1 Water In Chamber</p>	<p>Occurs if excess water is sensed in the chamber.</p>	<div style="border: 1px solid black; padding: 5px;"> <p>STATUS.. ALARM! WATER IN CHAMBER 209</p> <p>CHAMBER: 000.0 C 0.00 Pbar</p> <p>WARNING - BURN HAZARD! CHAMBER MAY BE FILLED WITH STEAM CONDENSATE</p> <p>OPERATOR INSTRUCTIONS:</p> <ol style="list-style-type: none"> 1. DO NOT OPEN DOOR 2. SILENCE ALARM 3. CALL SERVICE IMMEDIATELY <div style="display: flex; justify-content: space-around; margin-top: 10px;"> <div style="border: 1px solid black; padding: 2px 5px;">SILENCE ALARM</div> <div style="border: 1px solid black; padding: 2px 5px;">STATUS PRINT</div> <div style="border: 1px solid black; padding: 2px 5px;">PAPER FEED</div> <div style="border: 1px solid black; padding: 2px 5px;">SERVICE HELP</div> </div> </div> <hr/> <p style="text-align: center;">Screen with Service Instructions</p> <hr/> <div style="border: 1px solid black; padding: 5px;"> <p>STATUS.. SERVICE INFORMATION: WATER IN CHAMBER 210</p> <p>→ EXCESS WATER SENSED IN CHAMBER, WARNING! BURN HAZARD</p> <p>CAUSES AND CORRECTION:</p> <ol style="list-style-type: none"> 1. JACKET STRAINER PLUGGED → CLEAN 2. JACKET TRAP FAILED CLOSED → REPAIR 3. CHAMBER TRAP FAILED CLOSED → REPAIR 4. WATER ENTERED CHAMBER THROUGH STEAM PIPING → CHECK BOILER OR STEAM GENERATOR → REPAIR PIPING 5. WATER FLOAT SENSOR MALFUNCTION → REPAIR <div style="display: flex; justify-content: space-around; margin-top: 10px;"> <div style="border: 1px solid black; padding: 2px 5px;">PAPER FEED</div> <div style="border: 1px solid black; padding: 2px 5px;">EXIT</div> </div> </div>
<p>12.4.2 Too Long In Jacket Charge</p>	<p>Occurs if jacket does not reach set temperature within allotted time.</p>	<div style="border: 1px solid black; padding: 5px;"> <p style="text-align: center;">Screen with Operator Instructions</p> <hr/> <p>STATUS.. ALARM! TOO LONG IN JACKET CHARGE 231</p> <p>CHAMBER: 000.0 C 0.00 Pbar JACKET: 000.0 C</p> <p>STERILIZER WILL:</p> <ul style="list-style-type: none"> • REMAIN IN ALARM CONDITION UNTIL JACKET TEMP. IS REACHED <p>OPERATOR INSTRUCTIONS:</p> <ol style="list-style-type: none"> 1. SILENCE ALARM 2. CHECK STEAM SUPPLY VALVE → IF CLOSED, OPEN VALVE 3. IF ALARM RECURS, CALL SERVICE <div style="display: flex; justify-content: space-around; margin-top: 10px;"> <div style="border: 1px solid black; padding: 2px 5px;">SILENCE ALARM</div> <div style="border: 1px solid black; padding: 2px 5px;">STATUS PRINT</div> <div style="border: 1px solid black; padding: 2px 5px;">PAPER FEED</div> <div style="border: 1px solid black; padding: 2px 5px;">SERVICE HELP</div> </div> </div>

Alarm	Description	Screen with Service Instructions
12.4.2 Too Long In Jacket Charge, Continued		<div style="border: 1px solid black; padding: 5px;"> <p>STATUS.. SERVICE INFORMATION: 232 TOO LONG IN JACKET CHARGE</p> <p>→ JACKET DID NOT REACH REQUIRED TEMPERATURE WITHIN ALLOTTED TIME</p> <p>CAUSES AND CORRECTION:</p> <ol style="list-style-type: none"> 1. STEAM PRESSURE LESS THAN 3.45 Pbar → CHECK STEAM SUPPLY PIPING 2. STEAM REGULATOR MALFUNCTION → REPAIR 3. SOLENOID VALVE MALFUNCTION → REPAIR S09 4. CONTROL OUT OF CALIBRATION → RECALIBRATE (CONTACT QUALIFIED SERVICE PERSON) <div style="display: flex; justify-content: space-between; margin-top: 10px;"> <div style="border: 1px solid black; padding: 2px 5px;">PAPER FEED</div> <div style="border: 1px solid black; padding: 2px 5px;">EXIT</div> </div> </div>
12.4.3 Too Long To Seal Door	Occurs if door seal does not reach 0.35 Pbar (5 psig) within allotted time.	<div style="border: 1px solid black; padding: 5px; margin-bottom: 5px;"> <p style="text-align: center;">Screen with Operator Instructions</p> <hr/> <p>STATUS.. ALARM! 227 TOO LONG TO SEAL DOOR</p> <p>CHAMBER: 000.0 C 0.00 Pbar</p> <p>STERILIZER WILL:</p> <ul style="list-style-type: none"> • AUTOMATICALLY ABORT CYCLE <p>OPERATOR INSTRUCTIONS:</p> <ol style="list-style-type: none"> 1. SILENCE ALARM 2. CHECK STEAM SUPPLY VALVE → IF CLOSED, OPEN VALVE AND RESELECT CYCLE 3. IF ALARM RECURS, CALL SERVICE <div style="display: flex; justify-content: space-around; margin-top: 10px;"> <div style="border: 1px solid black; padding: 2px 5px;">SILENCE ALARM</div> <div style="border: 1px solid black; padding: 2px 5px;">STATUS PRINT</div> <div style="border: 1px solid black; padding: 2px 5px;">PAPER FEED</div> <div style="border: 1px solid black; padding: 2px 5px;">SERVICE HELP</div> </div> </div> <div style="border: 1px solid black; padding: 5px;"> <p style="text-align: center;">Screen with Service Instructions</p> <hr/> <p>STATUS.. SERVICE INFORMATION: 228 TOO LONG TO SEAL DOOR</p> <p>→ DOOR SEAL DID NOT REACH 0.69 Pbar WITHIN ALLOTTED TIME</p> <p>CAUSES AND CORRECTION:</p> <ol style="list-style-type: none"> 1. SEAL PRESSURE SWITCH MALFUNCTION → READJUST PS1(Ps2) → REPAIR PS1(Ps2) 2. SEAL NOT ACTIVATING → CHECK SEAL STEAM → CHECK SEAL EXHAUST 3. SOLENOID VALVE MALFUNCTION → REPAIR S35(S36) <div style="display: flex; justify-content: space-around; margin-top: 10px;"> <div style="border: 1px solid black; padding: 2px 5px;">PAPER FEED</div> <div style="border: 1px solid black; padding: 2px 5px;">CLEAR ALARM</div> <div style="border: 1px solid black; padding: 2px 5px;">EXIT</div> </div> </div>

Alarm	Description	Screen with Operator Instructions						
<p>12.4.4 Too Long To Unseal Door</p>	<p>Occurs if door seal pressure does not drop below 0.35 Pbar (5 psig) within allotted time.</p>	<div data-bbox="834 220 1455 651"> <p>STATUS.. ALARM! TOO LONG TO UNSEAL DOOR 229</p> <p>CHAMBER: 000.0 C 0.00 Pbar</p> <p>STERILIZER WILL:</p> <ul style="list-style-type: none"> REMAIN IN ALARM CONDITION UNTIL DOOR IS UNSEALED <p>OPERATOR INSTRUCTIONS:</p> <ol style="list-style-type: none"> SILENCE ALARM CALL SERVICE If load must be removed, refer to emergency door operation procedure in operating manual. <table border="1" data-bbox="857 541 1432 625"> <tr> <td>SILENCE ALARM</td> <td>STATUS PRINT</td> <td>PAPER FEED</td> <td>SERVICE HELP</td> </tr> </table> </div> <hr/> <div data-bbox="834 693 1455 1186"> <p align="center">Screen with Service Instructions</p> <p>STATUS.. SERVICE INFORMATION: TOO LONG TO UNSEAL DOOR 230</p> <p>→ DOOR SEAL PRESSURE NOT BELOW 0.35 Pbar WITHIN ALLOTTED TIME</p> <p>CAUSES AND CORRECTION:</p> <ol style="list-style-type: none"> SEAL PRESSURE SWITCH MALFUNCTION <ul style="list-style-type: none"> → READJUST PS1(PS2) → REPAIR PS1(PS2) SEAL NOT RETRACTING <ul style="list-style-type: none"> → CHECK SEAL STEAM → CHECK SEAL EXHAUST SOLENOID VALVE MALFUNCTION <ul style="list-style-type: none"> → REPAIR S37(S38) → REPAIR S35(S36) <table border="1" data-bbox="857 1117 1432 1171"> <tr> <td>PAPER FEED</td> <td>EXIT</td> </tr> </table> </div>	SILENCE ALARM	STATUS PRINT	PAPER FEED	SERVICE HELP	PAPER FEED	EXIT
SILENCE ALARM	STATUS PRINT	PAPER FEED	SERVICE HELP					
PAPER FEED	EXIT							
<p>12.4.5 Chamber Pressure Transducer Failure</p>	<p>Occurs if chamber pressure reading is outside the normal range.</p>	<div data-bbox="834 1312 1455 1753"> <p align="center">Screen with Operator Instructions</p> <p>STATUS.. ALARM! CHAMBER 217</p> <p>CHAMBER: 000.0 C 0.00 Pbar</p> <p>STERILIZER WILL:</p> <ul style="list-style-type: none"> AUTOMATICALLY ABORT CYCLE <p>OPERATOR INSTRUCTIONS:</p> <ol style="list-style-type: none"> SILENCE ALARM <table border="1" data-bbox="857 1648 1432 1732"> <tr> <td>SILENCE</td> <td>STATUS</td> <td>PAPER</td> <td>SERVICE</td> </tr> </table> </div>	SILENCE	STATUS	PAPER	SERVICE		
SILENCE	STATUS	PAPER	SERVICE					

Alarm	Description	Screen with Service Instructions
<p>12.4.5 Chamber Pressure Transducer Failure, Continued</p>		<div style="border: 1px solid black; padding: 5px;"> <p>STATUS.. SERVICE INFO: CHAMBER PRESSURE TRANSDUCER FAILURE 218</p> <p>→ TRANSDUCER, CP, OUTPUT VOLTAGE IS OUTSIDE NORMAL RANGE</p> <p>CAUSES AND CORRECTION:</p> <ol style="list-style-type: none"> 1. LOOSE CONNECTION IN TRANSDUCER WIRING → REPAIR 2. TRANSDUCER FAILED → REPAIR → RECALIBRATE 3. CONTROL OUT OF CALIBRATION → RECALIBRATE (CONTACT QUALIFIED SERVICE PERSON) 4. MAIN CONTROL FAILURE → CHECK CONTROL BOARD POWER STATUS LEDs → REPLACE CONTROL BOARD → RECALIBRATE <div style="display: flex; justify-content: space-between; margin-top: 10px;"> <div style="border: 1px solid black; padding: 2px 5px;">PAPER FEED</div> <div style="border: 1px solid black; padding: 2px 5px;">EXIT</div> </div> </div>
<p>12.4.6 Chamber Temperature Probe Failure</p>	<p>Occurs if chamber temperature reading is outside the normal range.</p>	<div style="border: 1px solid black; padding: 5px; margin-bottom: 10px;"> <p style="text-align: center;">Screen with Operator Instructions</p> <hr/> <p>STATUS.. ALARM! CHAMBER TEMPERATURE PROBE FAILURE 211</p> <p style="text-align: center;">CHAMBER: 000.0 C 0.00 Pbar</p> <p>STERILIZER WILL:</p> <ul style="list-style-type: none"> • AUTOMATICALLY ABORT CYCLE <p>OPERATOR INSTRUCTIONS:</p> <ol style="list-style-type: none"> 1. SILENCE ALARM 2. CALL SERVICE <div style="display: flex; justify-content: space-around; margin-top: 10px;"> <div style="border: 1px solid black; padding: 2px 5px;">SILENCE ALARM</div> <div style="border: 1px solid black; padding: 2px 5px;">STATUS PRINT</div> <div style="border: 1px solid black; padding: 2px 5px;">PAPER FEED</div> <div style="border: 1px solid black; padding: 2px 5px;">SERVICE HELP</div> </div> </div> <div style="border: 1px solid black; padding: 5px;"> <p style="text-align: center;">Screen with Service Instructions</p> <hr/> <p>STATUS.. SERVICE INFORMATION: CHAMBER TEMP PROBE FAILURE 212</p> <p>→ RTD PROBE, CT, OUTPUT IS OUTSIDE NORMAL RANGE</p> <p>CAUSES AND CORRECTION:</p> <ol style="list-style-type: none"> 1. LOOSE CONNECTION IN PROBE WIRING → REPAIR 2. PROBE FAILED → REPLACE → RECALIBRATE 3. CONTROL OUT OF CALIBRATION → RECALIBRATE (CONTACT QUALIFIED SERVICE PERSON) 4. MAIN CONTROL FAILURE → CHECK CONTROL BOARD POWER STATUS LEDs → REPLACE CONTROL BOARD → RECALIBRATE <div style="display: flex; justify-content: space-between; margin-top: 10px;"> <div style="border: 1px solid black; padding: 2px 5px;">PAPER FEED</div> <div style="border: 1px solid black; padding: 2px 5px;">EXIT</div> </div> </div>

Alarm	Description	Screen with Operator Instructions						
<p>12.4.7 Jacket Temperature Probe Failure</p>	<p>Occurs if jacket temperature reading is outside the normal range.</p>	<div data-bbox="834 220 1453 651"> <p>STATUS.. ALARM! JACKET TEMPERATURE PROBE FAILURE 213</p> <p>CHAMBER: 000.0 C 0.00 Pbar JACKET: 000.0 C</p> <p>STERILIZER WILL:</p> <ul style="list-style-type: none"> • AUTOMATICALLY ABORT CYCLE <p>OPERATOR INSTRUCTIONS:</p> <ol style="list-style-type: none"> 1. SILENCE ALARM 2. CALL SERVICE <table border="1" data-bbox="857 541 1430 625"> <tr> <td>SILENCE ALARM</td> <td>STATUS PRINT</td> <td>PAPER FEED</td> <td>SERVICE HELP</td> </tr> </table> </div> <hr/> <div data-bbox="834 682 1453 1207"> <p>Screen with Service Instructions</p> <p>STATUS.. SERVICE INFORMATION: JACKET TEMP PROBE FAILURE 214</p> <p>→ RTD PROBE, JT, OUTPUT IS OUTSIDE NORMAL RANGE</p> <p>CAUSES AND CORRECTION:</p> <ol style="list-style-type: none"> 1. LOOSE CONNECTION IN PROBE WIRING → REPAIR 2. PROBE FAILED → REPLACE → RECALIBRATE 3. CONTROL OUT OF CALIBRATION → RECALIBRATE (CONTACT QUALIFIED SERVICE PERSON) 4. MAIN CONTROL FAILURE → CHECK CONTROL BOARD POWER STATUS LEDs → REPLACE CONTROL BOARD → RECALIBRATE <table border="1" data-bbox="857 1123 1430 1176"> <tr> <td>PAPER FEED</td> <td>EXIT</td> </tr> </table> </div>	SILENCE ALARM	STATUS PRINT	PAPER FEED	SERVICE HELP	PAPER FEED	EXIT
SILENCE ALARM	STATUS PRINT	PAPER FEED	SERVICE HELP					
PAPER FEED	EXIT							
<p>12.4.8 Door Switch Failure</p>	<p>Occurs if door seal switch contact is made but door switch is still open.</p>	<div data-bbox="834 1262 1453 1764"> <p>Screen with Operator Instructions</p> <p>STATUS.. ALARM! DOOR SWITCH FAILURE 237</p> <p>CHAMBER: 000.0 C 0.00 Pbar</p> <p>STERILIZER WILL:</p> <ul style="list-style-type: none"> • AUTOMATICALLY ABORT CYCLE • EXHAUST CHAMBER TO ATMOSPHERIC PRESSURE <p>OPERATOR INSTRUCTIONS:</p> <ol style="list-style-type: none"> 1. SILENCE ALARM 2. CALL SERVICE <table border="1" data-bbox="857 1659 1430 1743"> <tr> <td>SILENCE ALARM</td> <td>STATUS PRINT</td> <td>PAPER FEED</td> <td>SERVICE HELP</td> </tr> </table> </div>	SILENCE ALARM	STATUS PRINT	PAPER FEED	SERVICE HELP		
SILENCE ALARM	STATUS PRINT	PAPER FEED	SERVICE HELP					

Alarm	Description	Screen with Service Instructions
12.4.8 Door Switch Failure, Continued		<div style="border: 1px solid black; padding: 5px;"> <p>STATUS.. SERVICE INFORMATION: 238 DOOR SWITCH FAILURE</p> <p>→ DOOR SWITCH OPEN WHILE SEAL SWITCH CLOSED</p> <p>CAUSES AND CORRECTION:</p> <ol style="list-style-type: none"> 1. DOOR SWITCH MALFUNCTION <ul style="list-style-type: none"> → CHECK LS1(LS2) CONNECTIONS → READJUST LS1(LS2) → REPAIR LS 1(LS2) 2. SEAL PRSSURE SWITCH MALFUNCTION <ul style="list-style-type: none"> → READJUST PS1(PS2) → REPAIR PS1(PS2) <div style="display: flex; justify-content: space-between; margin-top: 10px;"> <div style="border: 1px solid black; padding: 2px 5px;">PAPER FEED</div> <div style="border: 1px solid black; padding: 2px 5px;">EXIT</div> </div> </div>

12.5 Other Alarms

		Screen with Operator Instructions
12.5.1 Input/Output Board Communication Failure	Occurs if control input/output (I/O) board ceases operation.	<div style="border: 1px solid black; padding: 5px;"> <p>STATUS.. ALARM! 259 INPUT/OUTPUT BAORD #1 COMMUNICATION FAILURE</p> <p>CHAMBER: 000.0 C 0.00 Pbar</p> <p>STERILIZER WILL:</p> <ul style="list-style-type: none"> • AUTOMATICALLY ABORT CYCLE <p>OPERATOR INSTRUCTIONS:</p> <ol style="list-style-type: none"> 1. SILENCE ALARM 2. CALL SERVICE <div style="display: flex; justify-content: space-around; margin-top: 10px;"> <div style="border: 1px solid black; padding: 2px 5px;">SILENCE ALARM</div> <div style="border: 1px solid black; padding: 2px 5px;">STATUS PRINT</div> <div style="border: 1px solid black; padding: 2px 5px;">PAPER FEED</div> <div style="border: 1px solid black; padding: 2px 5px;">SERVICE HELP</div> </div> </div>

Alarm	Description	Screen with Operator Instructions				
12.5.2 Exhaust Rate Too Fast	Occurs if exhaust rate is too fast during Liquid Cycle sterilize phase.	<div style="border: 1px solid black; padding: 5px;"> <p>STATUS.. ALARM! 241 EXHAUST RATE TOO FAST CHAMBER: 000.0 C 0.00 Pbar</p> <p>STERILIZER WILL:</p> <ul style="list-style-type: none"> • AUTOMATICALLY TRY TO COMPLETE CYCLE • TRY TO EXHAUST CHAMBER ACCORDING TO OPTIMAL COOLING RATE <p>OPERATOR INSTRUCTIONS:</p> <ol style="list-style-type: none"> 1. SILENCE ALARM 2. IF ALARM RECURS, CALL SERVICE <table border="1" style="width: 100%; text-align: center; margin-top: 10px;"> <tr> <td style="padding: 5px;">SILENCE ALARM</td> <td style="padding: 5px;">STATUS PRINT</td> <td style="padding: 5px;">PAPER FEED</td> <td style="padding: 5px;">SERVICE HELP</td> </tr> </table> </div>	SILENCE ALARM	STATUS PRINT	PAPER FEED	SERVICE HELP
SILENCE ALARM	STATUS PRINT	PAPER FEED	SERVICE HELP			
12.5.3 Exhaust Rate Too Slow	Occurs if exhaust rate is too slow during Liquid Cycle sterilize phase.	<div style="border: 1px solid black; padding: 5px;"> <p style="text-align: right;">Screen with Operator Instructions</p> <hr/> <p>STATUS.. ALARM! 243 EXHAUST RATE TOO SLOW CHAMBER: 000.0 C 0.00 Pbar</p> <p>STERILIZER WILL:</p> <ul style="list-style-type: none"> • AUTOMATICALLY TRY TO COMPLETE CYCLE • TRY TO EXHAUST CHAMBER ACCORDING TO OPTIMAL COOLING RATE <p>OPERATOR INSTRUCTIONS:</p> <ol style="list-style-type: none"> 1. SILENCE ALARM 2. IF ALARM RECURS, CALL SERVICE <table border="1" style="width: 100%; text-align: center; margin-top: 10px;"> <tr> <td style="padding: 5px;">SILENCE ALARM</td> <td style="padding: 5px;">STATUS PRINT</td> <td style="padding: 5px;">PAPER FEED</td> <td style="padding: 5px;">SERVICE HELP</td> </tr> </table> </div>	SILENCE ALARM	STATUS PRINT	PAPER FEED	SERVICE HELP
SILENCE ALARM	STATUS PRINT	PAPER FEED	SERVICE HELP			

Alarm	Description	Screen with Operator Instructions				
<p>12.5.4 Atmospheric Pressure Alarm</p>	<p>Occurs if an error occurs reading the atmospheric pressure setting.</p>	<div data-bbox="873 222 1490 646" style="border: 1px solid black; padding: 5px;"> <p>STATUS.. ALARM! 269 ATMOSPHERIC PRESSURE ALARM</p> <p>CHAMBER: 000.0 C 0.00 Pbar ALTIUDE SETTING: 0 TO 1000 FEET</p> <p>OPERATOR INSTRUCTIONS: 1. SILENCE ALARM 2. CALL SERVICE</p> <table border="1" data-bbox="894 543 1469 625" style="width: 100%; text-align: center; border-collapse: collapse;"> <tr> <td style="padding: 2px 5px;">SILENCE ALARM</td> <td style="padding: 2px 5px;">STATUS PRINT</td> <td style="padding: 2px 5px;">PAPER FEED</td> <td style="padding: 2px 5px;">SERVICE HELP</td> </tr> </table> </div>	SILENCE ALARM	STATUS PRINT	PAPER FEED	SERVICE HELP
SILENCE ALARM	STATUS PRINT	PAPER FEED	SERVICE HELP			
<p>12.5.5 Display Error</p>	<p>Occurs if control experiences communication loss with display.</p>	<div data-bbox="873 1297 1490 1764" style="border: 1px solid black; padding: 5px;"> <p style="text-align: right;">Screen with Operator Instructions</p> <hr/> <p>STATUS.. ALARM! 263 DISPLAY ERROR</p> <p>CHAMBER: 000.0 C 0.00 Pbar</p> <p>STERILIZER WILL: • AUTOMATICALLY TRY TO COMPLETE CYCLE</p> <p>OPERATOR INSTRUCTIONS: 1. SILENCE ALARM 2. CALL SERVICE</p> <table border="1" data-bbox="894 1661 1469 1743" style="width: 100%; text-align: center; border-collapse: collapse;"> <tr> <td style="padding: 2px 5px;">SILENCE ALARM</td> <td style="padding: 2px 5px;">STATUS PRINT</td> <td style="padding: 2px 5px;">PAPER FEED</td> <td style="padding: 2px 5px;">SERVICE HELP</td> </tr> </table> </div>	SILENCE ALARM	STATUS PRINT	PAPER FEED	SERVICE HELP
SILENCE ALARM	STATUS PRINT	PAPER FEED	SERVICE HELP			

Alarm	Description	Screen with Operator Instructions				
<p>12.5.6 Too Long in Sterilize</p>	<p>Occurs if actual sterilize phase time exceeds cycle parameter setting.</p>	<div style="border: 1px solid black; padding: 5px;"> <p style="text-align: right;">233</p> <p>STATUS.. ALARM! TOO LONG IN STERILIZE</p> <p>CHAMBER: 000.0 C 0.00 Pbar</p> <p>STERILIZER WILL:</p> <ul style="list-style-type: none"> • AUTOMATICALLY ABORT CYCLE <p>OPERATOR INSTRUCTIONS:</p> <ol style="list-style-type: none"> 1. SILENCE ALARM 2. CALL SERVICE <table border="1" style="width: 100%; text-align: center; margin-top: 10px;"> <tr> <td style="padding: 5px;">SILENCE ALARM</td> <td style="padding: 5px;">STATUS PRINT</td> <td style="padding: 5px;">PAPER FEED</td> <td style="padding: 5px;">SERVICE HELP</td> </tr> </table> </div>	SILENCE ALARM	STATUS PRINT	PAPER FEED	SERVICE HELP
SILENCE ALARM	STATUS PRINT	PAPER FEED	SERVICE HELP			
<p>12.5.7 Door "A" Seal Failure – Out of Cycle</p>	<p>Occurs if sterilizer encounters a delay when trying to seal Door "A."</p>	<div style="border: 1px solid black; padding: 5px;"> <p style="text-align: right;">261</p> <p>STATUS.. ALARM! DOOR "A" SEAL FAILURE</p> <p>CHAMBER: 000.0 C 0.00 Pbar</p> <p>STERILIZER WILL:</p> <ul style="list-style-type: none"> • AUTOMATICALLY ATTEMPT TO SEAL THE DOOR <p>OPERATOR INSTRUCTIONS:</p> <ol style="list-style-type: none"> 1. SILENCE ALARM 2. CALL SERVICE <table border="1" style="width: 100%; text-align: center; margin-top: 10px;"> <tr> <td style="padding: 5px;">SILENCE ALARM</td> <td style="padding: 5px;">STATUS PRINT</td> <td style="padding: 5px;">PAPER FEED</td> <td style="padding: 5px;">SERVICE HELP</td> </tr> </table> </div>	SILENCE ALARM	STATUS PRINT	PAPER FEED	SERVICE HELP
SILENCE ALARM	STATUS PRINT	PAPER FEED	SERVICE HELP			

Alarm	Description	Screen with Operator Instructions
12.5.8 Door "B" Seal Failure – Out of Cycle	Occurs if sterilizer encounters a delay when trying to seal Door "B."	<div style="border: 1px solid black; padding: 5px;"> <p>STATUS.. ALARM! 261 DOOR "B" SEAL FAILURE</p> <p>CHAMBER: 000.0 C 0.00 Pbar</p> <p>STERILIZER WILL: • AUTOMATICALLY ATTEMPT TO SEAL THE DOOR</p> <p>OPERATOR INSTRUCTIONS: 1. SILENCE ALARM 2. CALL SERVICE</p> <div style="display: flex; justify-content: space-around; margin-top: 10px;"> <div style="border: 1px solid black; padding: 2px 5px; text-align: center;">SILENCE ALARM</div> <div style="border: 1px solid black; padding: 2px 5px; text-align: center;">STATUS PRINT</div> <div style="border: 1px solid black; padding: 2px 5px; text-align: center;">PAPER FEED</div> <div style="border: 1px solid black; padding: 2px 5px; text-align: center;">SERVICE HELP</div> </div> </div>

Life Sciences

⚠ WARNING – BURN HAZARD: Allow sterilizer, generator (if applicable) and accessories to cool to room temperature before performing any cleaning or maintenance procedures.

⚠ WARNING – SHOCK HAZARD: Disconnect all utilities to sterilizer before servicing. See Section 1 for expanded warning.

⚠ WARNING – PERSONAL INJURY AND EQUIPMENT DAMAGE HAZARD: Repairs and adjustments to this equipment must be made only by fully qualified service personnel. Maintenance performed by inexperienced, unqualified persons or installation of unauthorized parts could cause personal injury or result in costly equipment damage.

The material in this section is provided to allow for servicing components of the sterilizer most likely to need attention. These procedures are more advanced than cleaning and replacing expendables (such as printer paper and door gaskets). These procedures should always be performed by an experienced, trained service technician.

13.1 Air Filter Replacement

The purpose of the bacterial air filter is to filter air entering the sterilization chamber. The chamber is exposed to contamination whenever the filter or the air lines below the filter are opened. Keep these components as clean as possible when servicing. The bacterial air filter contains a replaceable filter cartridge, refer to Preventative Maintenance Schedule for frequency.

1. Remove the bowl from the filter body by loosening the retaining nut.
2. Remove the old filter element and discard.
3. Insert the new filter element (P129360-802) into the bowl.
4. Replace the bowl and tighten the retaining nut.

13.2 Clean Strainers

⚠ WARNING – BURN HAZARD: Failure to shut off the steam supply when cleaning or replacing strainers can result in serious injury.

The strainers should be opened for cleaning after initial start-up and at least twice a year thereafter (refer to Preventative Maintenance Schedule). Accumulation of sediment and rust will reduce pressure and flow. In extreme conditions, complete blockage may occur.

• Disassembly

Shut off supply and then vent pressure in line by running a short sterilizer cycle. Abort the cycle when no pressure is present in the steam or water lines.

1. Assure water and steam lines are still shut off.
2. Remove hex plug and gasket.
3. Pull out strainer screen from body.
4. Scrape and polish all rust and residue from strainer screen and body. Use a wire brush or steel wool. Be sure that all perforations are clear. Replace screen if damaged, rusted or corroded.

• Reassembly

1. Insert screen into strainer body. Take care that no dirt or other particles remain in strainer body.
2. Replace and tighten hex plug. Use a new gasket if necessary.
3. Make certain that all pipe connections are tight after assembly.

Refer to Figure 13-1

• Disassembly

1. Using a suitable wrench, unscrew and remove the cap and attached bellows assembly.
2. Remove seat from body using a hex socket wrench.
3. Wipe out bowl taking care that loose material does not enter the piping.

• Reassembly

1. Screw new seat in firmly. (Use a socket head wrench to tighten.)

NOTE: Seat and bellows are a lapped pair.

2. Install new bellows.
3. Replace cap and attached bellows assembly, using a new gasket.
4. Check for leaks.

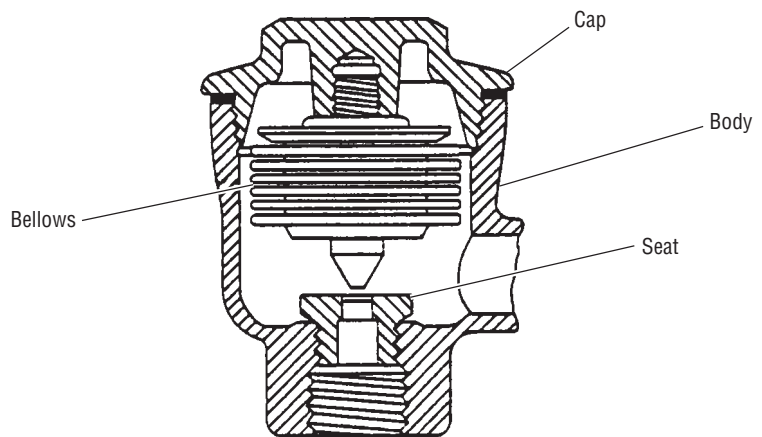

Figure 13-1. Steam Trap

13.4 Steam Trap Replacement

WARNING – BURN HAZARD: Allow sterilizer and accessories to cool to room temperature before performing any cleaning or maintenance procedures.

WARNING – BURN HAZARD: Jacket pressure must be at 0 psig before beginning work on the steam trap.

CAUTION: Allow thermostatic traps to cool down to room temperature before removing cover. Since there is nothing to limit expansion, the bellows may rupture or fatigue if

13.5 Clean or Replace Valves

⚠ WARNING – BURN HAZARD: Allow sterilizer and accessories to cool to room temperature before performing any cleaning or maintenance procedures.

⚠ WARNING – BURN HAZARD: Proper testing of the safety valve requires the valve to be operated under pressure. Exhaust from the safety valve is hot and can cause burns. Proper safety attire (gloves, eye protection, insulated overall) as designated by OSHA, is required. Testing is to be performed by qualified service personnel only.

⚠ CAUTION: Actuation at less than 75% of rated pressure can allow debris to contaminate the seat and cause the safety valve to leak. A leaking safety valve must be replaced.

• Check Valves

Repair of check valves is limited to cleaning of valve seats when foreign matter causes improper operation. When a valve becomes defective, replace the entire valve; or repair the valve if a repair kit is available.

• Solenoid Valves

Solenoid valve repair kits include complete instructions for rebuilding the valve.

• Steam Regulator

This is used for setting the correct supplied steam pressure. Incorrect adjustment of this valve can lead to improper sterilizer operation and therefore adjustment and rebuilding of this component should be referred to a qualified service technician.

• Safety Valves

The safety valves are to be tested periodically (refer to Preventive Maintenance Schedule at the beginning of *SECTION 11*).

1. To prevent damage to the safety valve, the valve must have at least 75% of its rated pressure when actuated. Actuating the try lever at less than 75% of rated pressure can allow debris to contaminate the seat and cause the valve to leak. Check current pressure level by observing chamber pressure gauge.
2. Open the try lever and hold the valve open for one to two seconds.
3. Allow the try lever to snap shut.

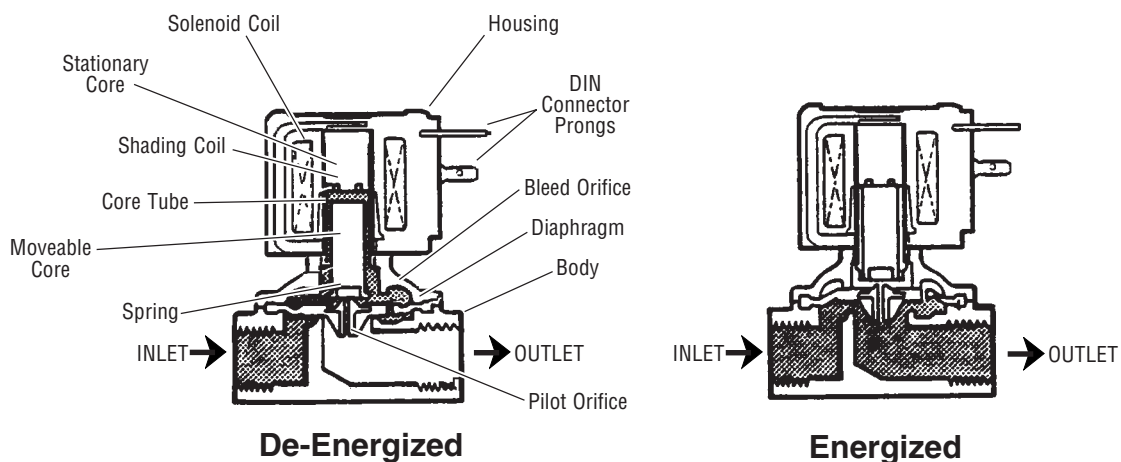

Figure 13-2. Internal Pilot-Operated Solenoid Valve.

Table 13-1. Replacement Parts
Amsco® Century™ Medium Steam Sterilizer 26 x 26" (660 x 660 mm)

Schematic Designation	Description	Part Number	
			S46 (NC) SOLENOID VALVE, Waste Cooling Water 093910-479
			• KIT, Repair 764076-001
CS1	SWITCH, Level, Chamber Flooded	093927-069	• COIL 764323-942
CK1	CHECK VALVE, Filtered Air	056402-067	SB1 BAFFLE, Chamber Steam (Single Door) 146660-550
	• KIT, Repair, CK1	764331-561	SB1 BAFFLE, Chamber Steam (Double Door) 146660-497
CK2	CHECK VALVE, Anti-cavitation	083521-001	ST1 STRAINER, Water
CK3	CHECK VALVE, Jacket Steam Trap	010278-091	ST2 STRAINER, Steam
CK4	CHECK VALVE, Constant Steam Bleed	150829-501	ST3 STRAINER, Jacket
	• KIT, Repair	764079-776	ST4 STRAINER, Chamber Drain
CK8	CHECK VALVE, Chamber Drain	056402-068	TR1 STEAM TRAP, Chamber Drain
	• KIT, Repair, CK8	764331-562	• KIT, Repair
DL1	LOCK, Door (OE, Hinged Door Only)	093911-202	TR2 STEAM TRAP, Jacket
DL2	LOCK, Door (NOE, Hinged Door Only)	093911-202	• KIT, Repair
DS1	SEAL, Door (OE)	129373-376	TR3 STEAM TRAP, Steam Supply
DS2	SEAL, Door (NOE)	129373-376	VP1 VACUUM PUMP
F1	FILTER, Chamber Air	101006-172	
F2	DIFFUSER, Steam	129373-528	CONTROL DISPLAY
FC1	RESTRICTOR, Water Flow, Vacuum Pump	764328-968	• MODULE, Color LCD ¹
FC2	VALVE, Needle, 1/8" PTF	083630-001	• PC BOARD, Color LCD Interface ¹
PT1	TRANSDUCER, Chamber Pressure	136816-078	• POWER SUPPLY, Color LCD ¹
RTD1, 4	RTD, Chamber, Recorder, Dual	093922-107	• SPEAKER ASSEMBLY ¹
RTD2	RTD, Waste Water Temperature	093911-351	• MOTOR, Take Up, Color LCD ¹
RTD3	RTD, Jacket Temperature	093911-351	• MODULE, Display (Mono) ²
RV1	SAFETY VALVE, Jacket	093921-266	• PC BOARD, Interface ²
S1 (NO)	SOLENOID VALVE, Filtered Air	093911-329	• PC BOARD, Printer ²
	• KIT, Repair	764324-895	• SCREEN, Touch ²
	• COIL	764323-741	• MOTOR, Take Up ²
S2 (NC)	SOLENOID VALVE, Steam to Chamber	093911-331	• SPOOL, Take Up
	• KIT, Repair	764317-688	• PRINTER
	• COIL	764323-941	• RIBBON, Printer (Pkg of 2)
S3 (NC)	SOLENOID VALVE, Fast Exhaust	093911-327	• PAPER (Box of 3)
	• KIT, Repair	764071-001	• SPEAKER
	• COIL	764324-600	• POWER SUPPLY ²
S4 (NC)	SOLENOID VALVE, Exhaust Cooling	093911-328	CONTROL BOX
	• KIT, Repair	764072-001	• PC BOARD, CPU ³
	• COIL	764323-940	• PC BOARD, Input/Output #1
S7 (NC)	SOLENOID VALVE, Vacuum Water	093910-479	• PC BOARD, Input/Output #2
	• KIT, Repair	764076-001	• POWER SUPPLY
	• COIL	764323-942	• SWITCH, Rocker
S9 (NC)	SOLENOID VALVE, Steam-to-Jacket	093911-331	• FUSE, 5A (Box of 5)
	• KIT, Repair	764317-688	RELAY, Solid-State, Motor Starter
	• COIL	764323-941	CURRENT BREAKER, Motor Starter
S35 (NC)	SOLENOID VALVE, Steam-to-Seal (OE)	093910-479	DOOR DRIVE (Sliding Door Units Only)
	• KIT, Repair	764076-001	• MOTOR
	• COIL	764323-942	• CABLE
S36 (NC)	SOLENOID VALVE, Steam-to-Seal (NOE)	093910-479	• SWITCH, Proximity
	• KIT, Repair	764076-001	
	• COIL	764323-942	
Schematic Designation	Description	Part Number	
S37 (NC)	SOLENOID VALVE, Seal Retraction (OE)	093910-479	
	• KIT, Repair	764076-001	
	• COIL	764323-942	
S38 (NC)	SOLENOID VALVE, Seal Retraction (NOE)	093910-479	
	• KIT, Repair	764076-001	
	• COIL	764323-942	
S40 (NC)	SOLENOID VALVE, Chamber Constant Bleed	093910-478	
	• KIT, Repair	764076-001	
	• COIL	764323-942	
S43 (NC)	SOLENOID VALVE, Vacuum Pump Drain	093910-479	
	• KIT, Repair	764076-001	
	• COIL	764323-942	

¹ Replacement part for color LCD display control, only.

² Replacement part for monochrome display control, only.

³ Unprogrammed PC board, see Maintenance Manual (P764330-117) for instructions.

Guide to Abbreviations on Pages 13-4 and 13-5 : OE = Operating End
 NOE = Non-operating End
 RTD = Resistive Thermal Detector

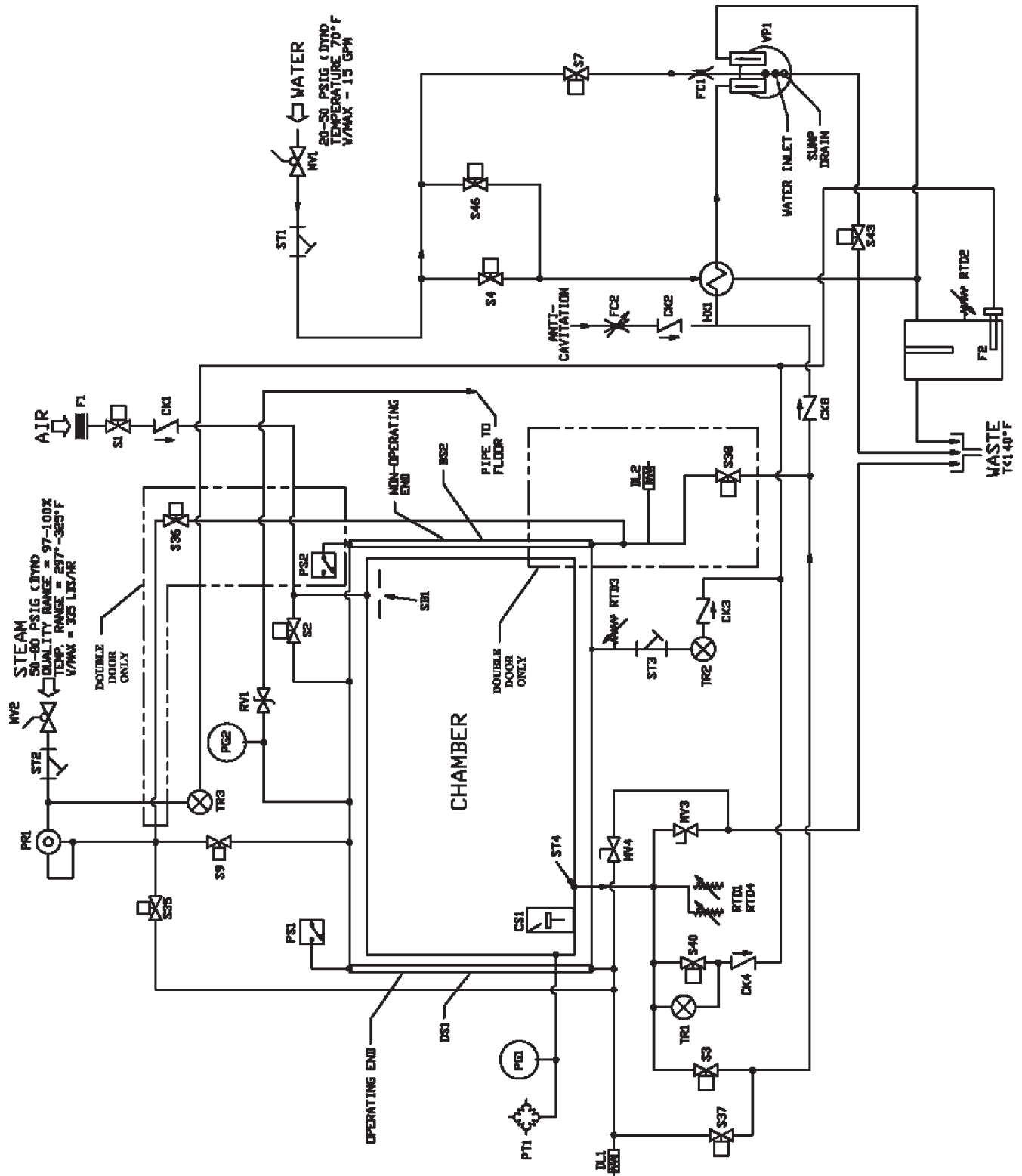

Figure 13-3. Piping Schematic (Parts Reference)

13.6 Recommended Spare Parts

To order replacement parts and/or supply products, proceed as follows:

1. Include the description and part/order number as listed in Table 13-1.
2. Include the model and serial numbers of your sterilizer on your order.
3. Send your order directly to the sales and service center serving your area.

Contact your sales representative for recommendations on cleaning products, biological indicators, or parts that are not listed below.

NOTE: *Use only STERIS authorized parts on this equipment. Use of unauthorized parts will void the warranty.*

13.7 Waste Products Disposal

The following are waste materials associated with the sterilizer. When disposing of waste materials, be sure to do so in compliance with federal, state and regulations.

- Printer paper - recyclable.
- Printer ribbon - not recyclable.
- Water filters - not recyclable.
- Waste water - 57 L/min (15 gal/min).
- Entire sterilizer (end-of-life) - Contact STERIS Corporation for disposal or recycling recommendations.

Each screen is identified by a number, located in the top right hand corner of the display screen. Numbers are used throughout the manual for reference only, and do not relate to the operating sequence of the screens.

The following table lists the reference number of each screen, in numerical order, and the corresponding page number(s) where it pictorially appears within this manual.

Screen Reference Table

Screen Reference Number	Page Number(s)
0	5-1, 6-2, 7-1, 10-14
1	4-6, 5-2, 6-2, 6-4, 6-12, 6-18, 6-24, 6-26, 6-28, 7-2, 8-2, 9-1, 10-1
10	6-32
102	10-10
103	10-10
11	6-32
111	10-23
117	10-13
118	8-11
12	9-22
126	7-1, 7-3, 10-21, 10-24, 10-25, 10-27
13	5-5, 7-3, 8-2, 8-16, 9-1, 10-1, 10-2, 10-3, 10-4, 10-11, 10-12
14	7-4, 8-3, 8-15, 9-2, 9-4, 9-8
15	8-3, 8-4, 8-15
16	8-4
17	10-19
180	9-14
181	9-14, 9-15, 9-16, 9-19
182	9-15, 9-16, 9-17, 9-18, 9-19, 9-20
184	9-17, 9-18
2	5-2, 5-4, 6-5, 6-12, 6-18, 6-24, 6-27, 6-29
20	8-5
200	12-3

Screen Reference Table (continued)

Screen Reference Number	Page Number(s)
201	12-3
202	12-3
203	12-4
204	12-4
205	12-1, 12-2
206	12-2
207	12-7
208	12-7
209	12-12
21	8-8
210	12-12
211	12-15
212	12-15
213	12-16
214	12-16
215	12-11
216	12-10
217	12-14
218	12-15
219	12-7
22	8-11, 8-14
220	12-8
221	12-10
222	12-11
223	12-5
224	12-5
225	12-4
226	12-5
227	12-13
228	12-13
229	12-14
230	12-14

Screen Reference Table (continued)

Screen Reference Number	Page Number(s)
231	12-12
232	12-13
233	12-20
235	12-6
236	12-6
237	12-16
238	12-17
239	12-9
240	12-9
241	12-18
243	12-18
245	12-10
246	12-10
259	12-17
261	12-20, 12-21
263	12-19
269	12-19
28	8-6
29	8-6
3	5-4, 6-24, 6-27, 6-30
30	8-7
31	8-7
32	8-8
33	8-9
332	10-34
34	8-9
35	8-10
36	8-10
37	8-12
38	8-12
39	9-3
4	5-3, 6-6

Screen Reference Table (continued)

Screen Reference Number	Page Number(s)
40	9-4
41	9-5
42	9-5
43	9-6
44	9-6
45	9-13
46	10-31
47	9-21
48	10-21, 10-25, 10-28, 10-30
49	9-12, 9-13
5	6-18, 6-19
50	9-9, 9-12, 9-14, 9-20, 9-22, 9-23
51	10-17, 10-18, 10-19, 10-20, 10-24, 10-28, 10-30, 10-32, 10-33
52	9-5
53	9-6, 9-8
54	9-7
55	9-7
56	9-9, 9-10, 9-11
57	9-10
58	9-11
59	9-7
6	6-12, 6-13
60	10-32
61	10-17, 10-33
66	10-18
7	6-11, 6-17, 6-22
77	8-5, 10-22, 10-26
78	7-2, 7-3, 10-16
79	10-5, 10-8, 10-9
8	8-13
80	10-21

Screen Reference Table (continued)

Screen Reference Number	Page Number(s)
81	10-25
82	10-22
83	10-26, 10-29
84	10-23
85	10-27, 10-29
87	5-6, 10-2, 10-14, 10-15, 10-16, 10-34
88	10-8
89	10-9
9	4-3, 6-6, 6-7, 6-8, 6-9, 6-10, 6-11, 6-13, 6-14, 6-15, 6-16, 6-17, 6-19, 6-20, 6-21, 6-22, 6-31
90	10-10
91	10-11, 10-12, 10-13
92	10-15
93	10-6, 10-8
94	10-6
97	10-7
98	10-7

Life Sciences