



Force-Based Controller for
Myoelectric Prosthesis
Oral Report 2

BME-5

Kaitlyn Ayers, Rebecca Jones, Allyson King,
Shaan Ramaprasad, Christian Stano



Overview

1. Background
2. Our Role
3. Needs Assessment
4. Design Approach
5. Progress Overview
6. Conclusion

Background

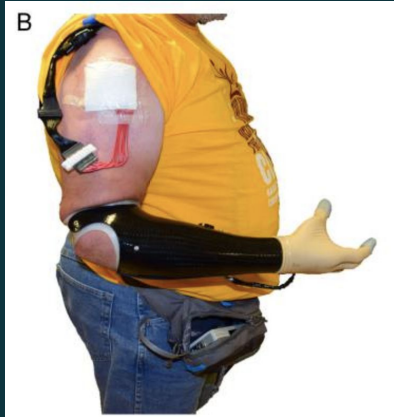
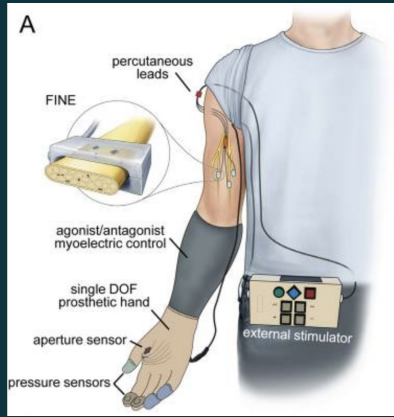

Traditional Prosthesis

Dissatisfaction due to lack of fine motor control and psychosocial repercussions

FINE

Flat Interface Nerve Electrodes (FINE)

Production of natural tactile sensation without paresthesia

Sensory Feedback

Integration of FINE system with a myoelectric prosthesis allows subjects to “feel”

Phase 2: in-home trials launched

Background

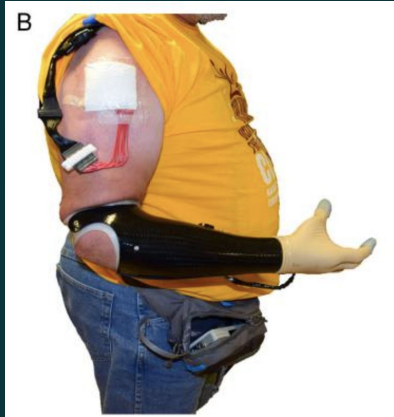
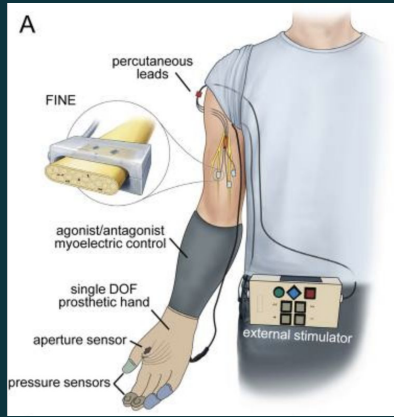

Traditional
Prosthesis

Dissatisfaction due to lack of fine motor control and psychosocial repercussions

FINE

Flat Interface Nerve Electrodes (FINE)

Production of natural tactile sensation without paresthesia

Sensory
Feedback

Integration of FINE system with a myoelectric prosthesis allows subjects to “feel”

Phase 2: in-home trials launched

Natural Muscle Control

Key Features:

1. Continuous sensory-motor control
2. Tactile + visual afferent feedback
3. Constant motor processing and hand movement coupling

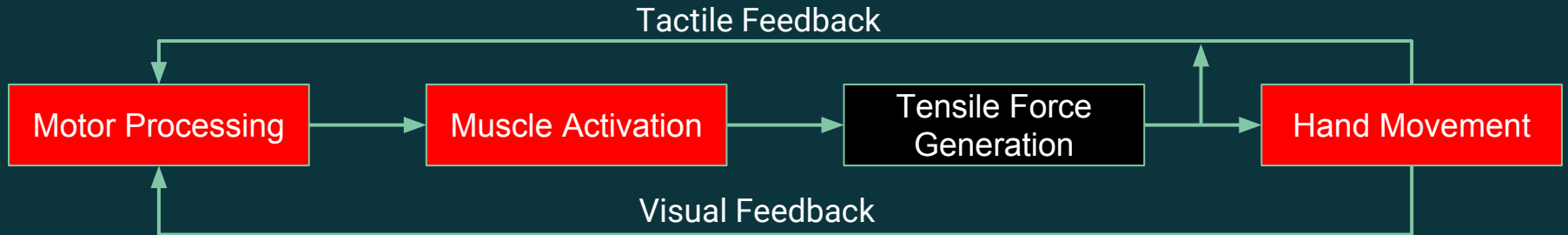

Current Velocity-Based Myoelectric Control

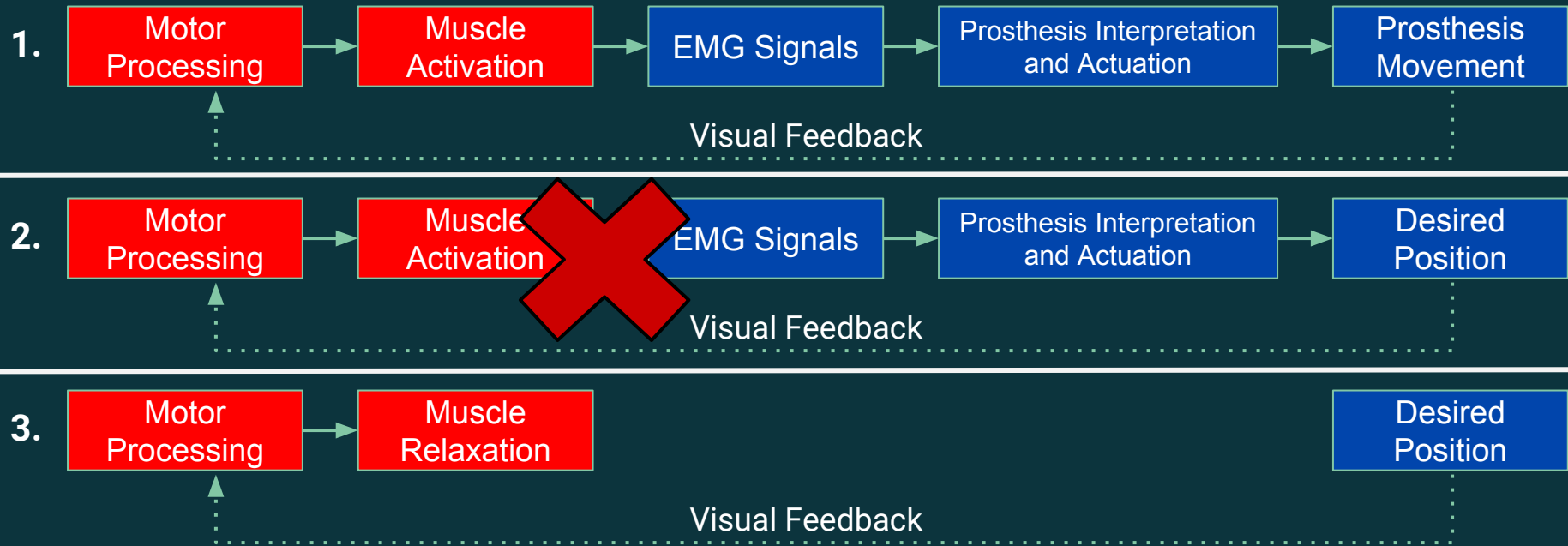

Our Role: Bridging a Gap

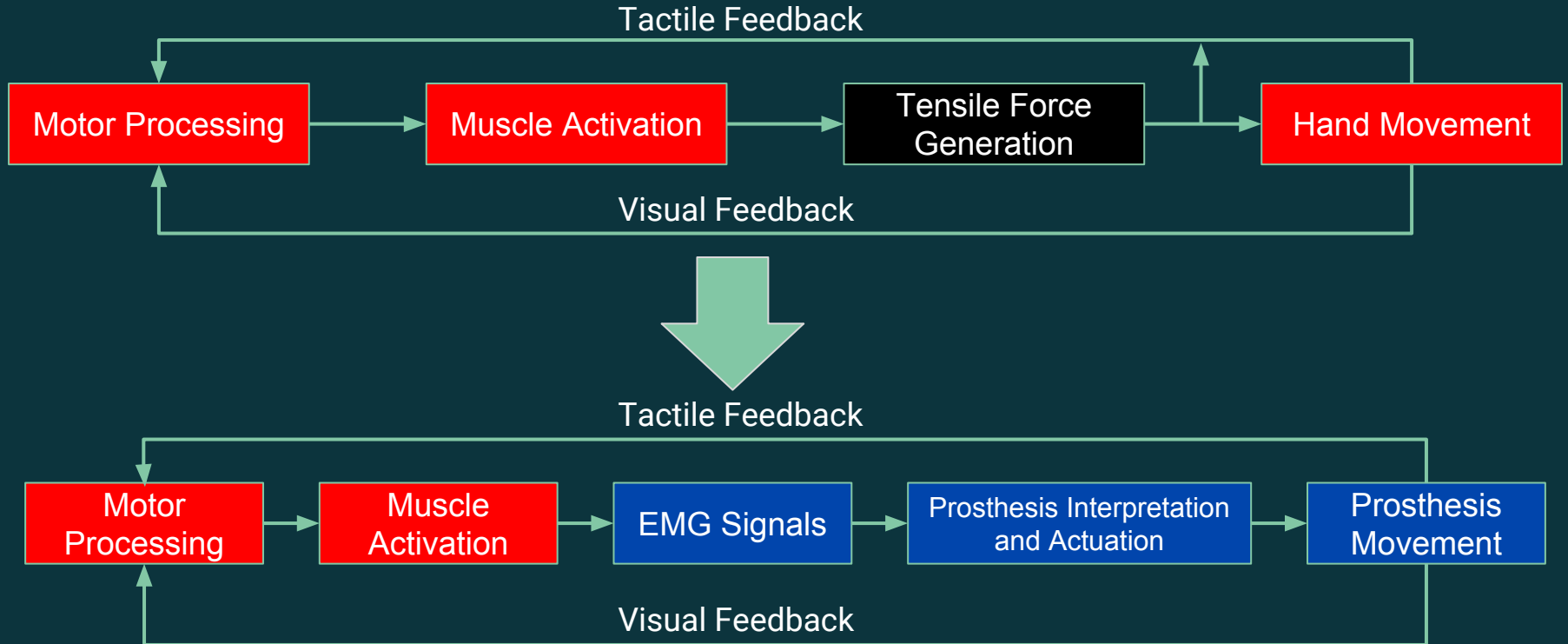



Highlights of Needs Assessment

- Adjustable to different
 - Patient Capabilities
 - Amputation types
- **Wearable**
- **Durable**
- **Safe and Easy to Use**
 - Patient Use
 - **Prosthetist/Lab Technician parameter manipulation**
- **Cost Effective**
- Software and Design Documentation
- Efficient EMG to prosthesis actuation

Design Approach

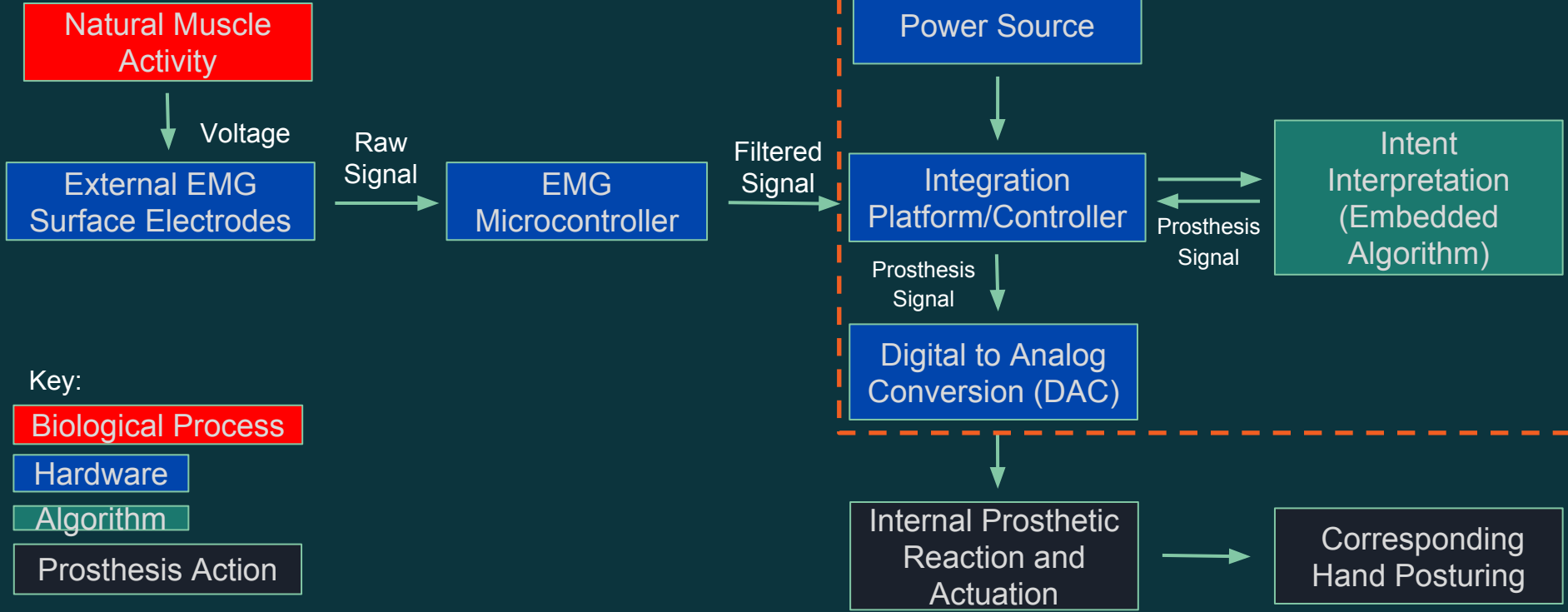

Key:

- Biological Process
- Hardware
- Algorithm
- Prosthesis Action

Division of Work

Rebecca and Kaitlyn

Allyson and Christian

Teensy/Arduino Platform

Natural Muscle Activity

Voltage

External EMG Surface Electrodes

Raw Signal

EMG Microcontroller

Filtered Signal

Power Source

Integration Platform/Controller

Intent Interpretation (Embedded Algorithm)

Prosthesis Signal

Digital to Analog Conversion (DAC)

Internal Prosthetic Reaction and Actuation

Corresponding Hand Posturing

Key:

Biological Process

Hardware

Algorithm

Prosthesis Action

Shaan

EMG Acquisition

- Signal will be obtained from EMG signals placed on the Extensor Digitorum and Flexor Digitorum
- Phantom testing designed with human subject
 - Motion will be limited where appropriate for correct signal acquisition

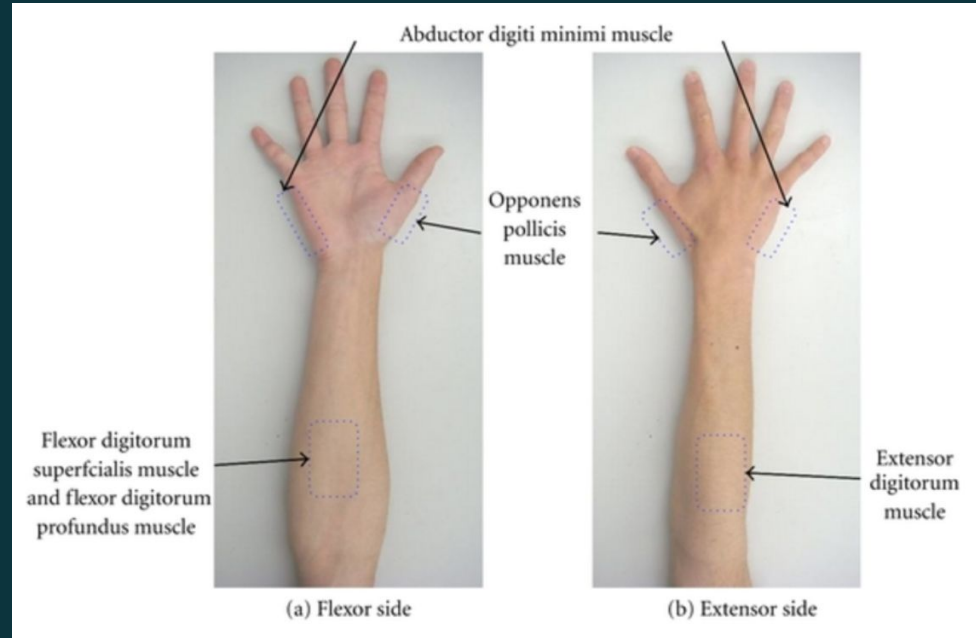

EMG Signal Interpretation

- Each movement should have a different EMG signal pattern
- Through analysis of known EMG patterns and customization for test subject, we hope to be able to classify different signals as different movements

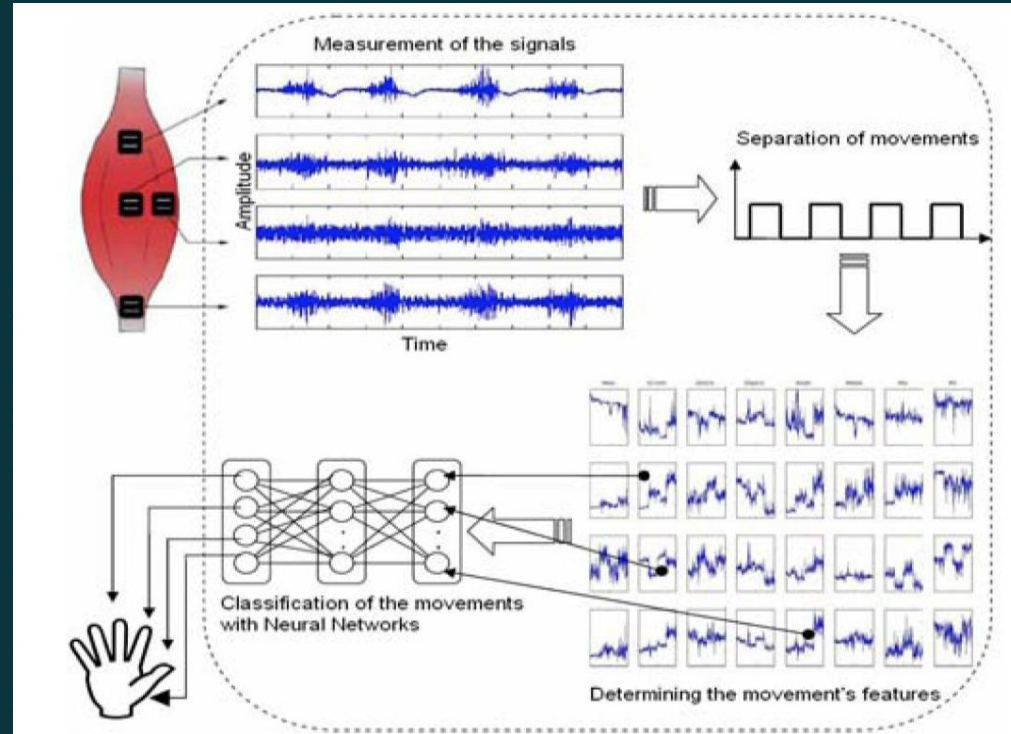

Hardware: Prosthesis

Ottobock Transcarpal Hand (8E44)

- Variable grip speed (force)
- Motor operates using PWM
- Issue: motor not moving with EMG input
 - Gain adjustments
 - Mechanical isolation
- Next Step: have prosthesis serviced by Ottobock



<https://professionals.ottobockus.com/Prosthetics/Upper-Limb-Prosthetics/Myo-Hands-and-Components/Myo-Terminal-Devices/Transcarpal-Hand-DMC-plus/p/8E44~56-R8%201~2>

Hardware: External Processing

- Teensy Development Boards
 - Arduino platform compatible
 - Increased Bandwidth
 - Compact and lightweight
 - No on-board power capabilities
- Myoware Sensors
 - On-board signal processing
 - Compact
 - Fixed signal placement
- Total Cost: \$110

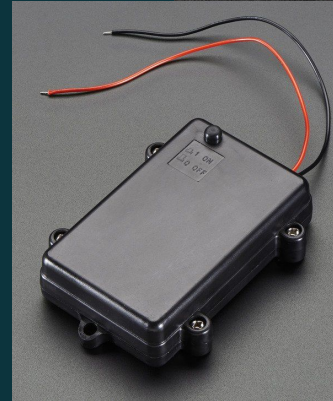
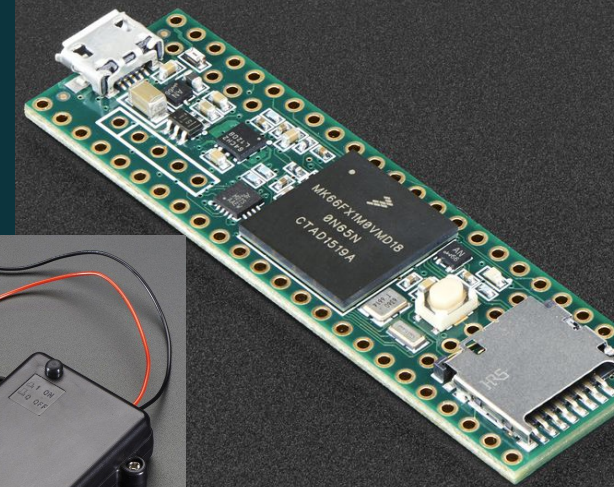

Novel Control System Scheme

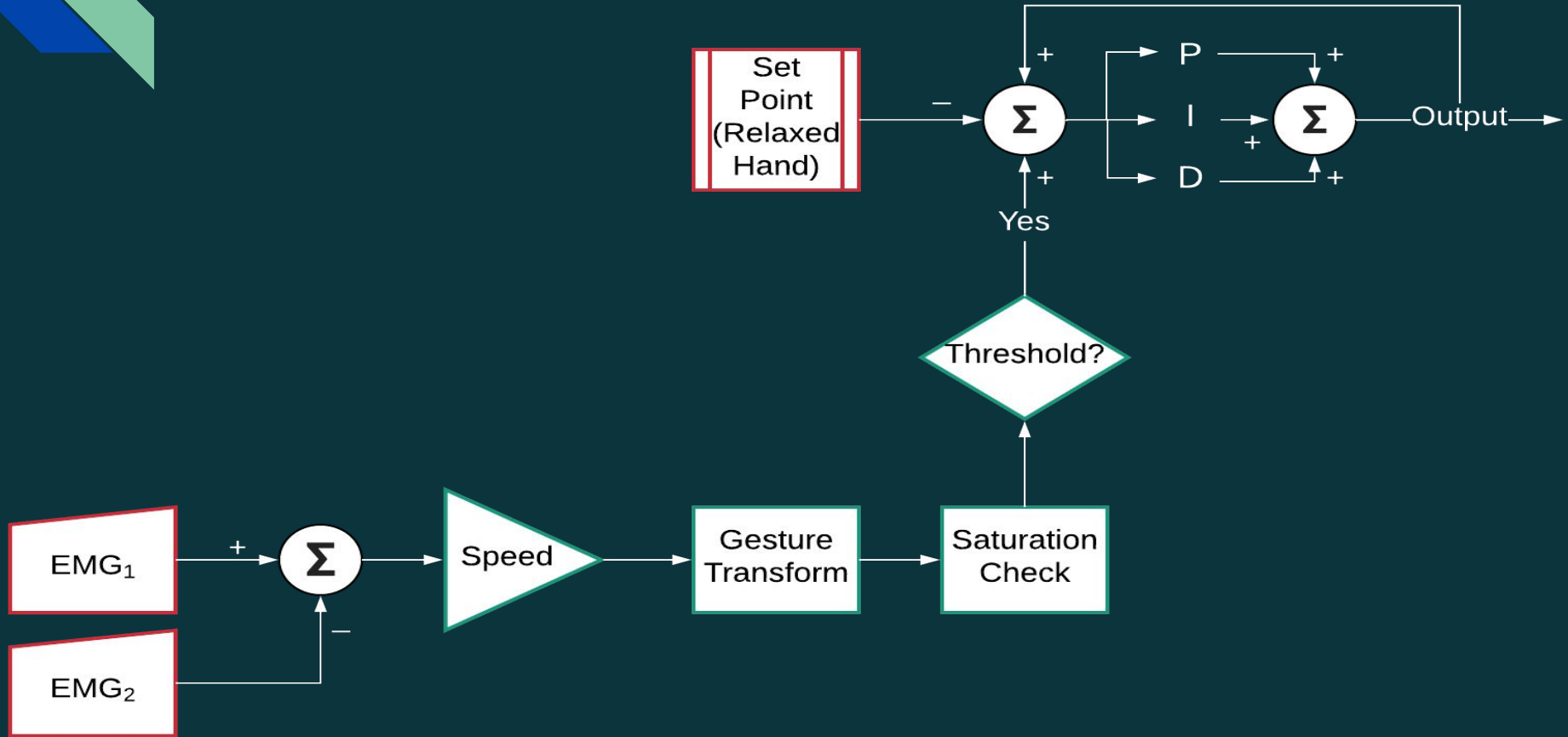

Where We Are and Where We Are Going

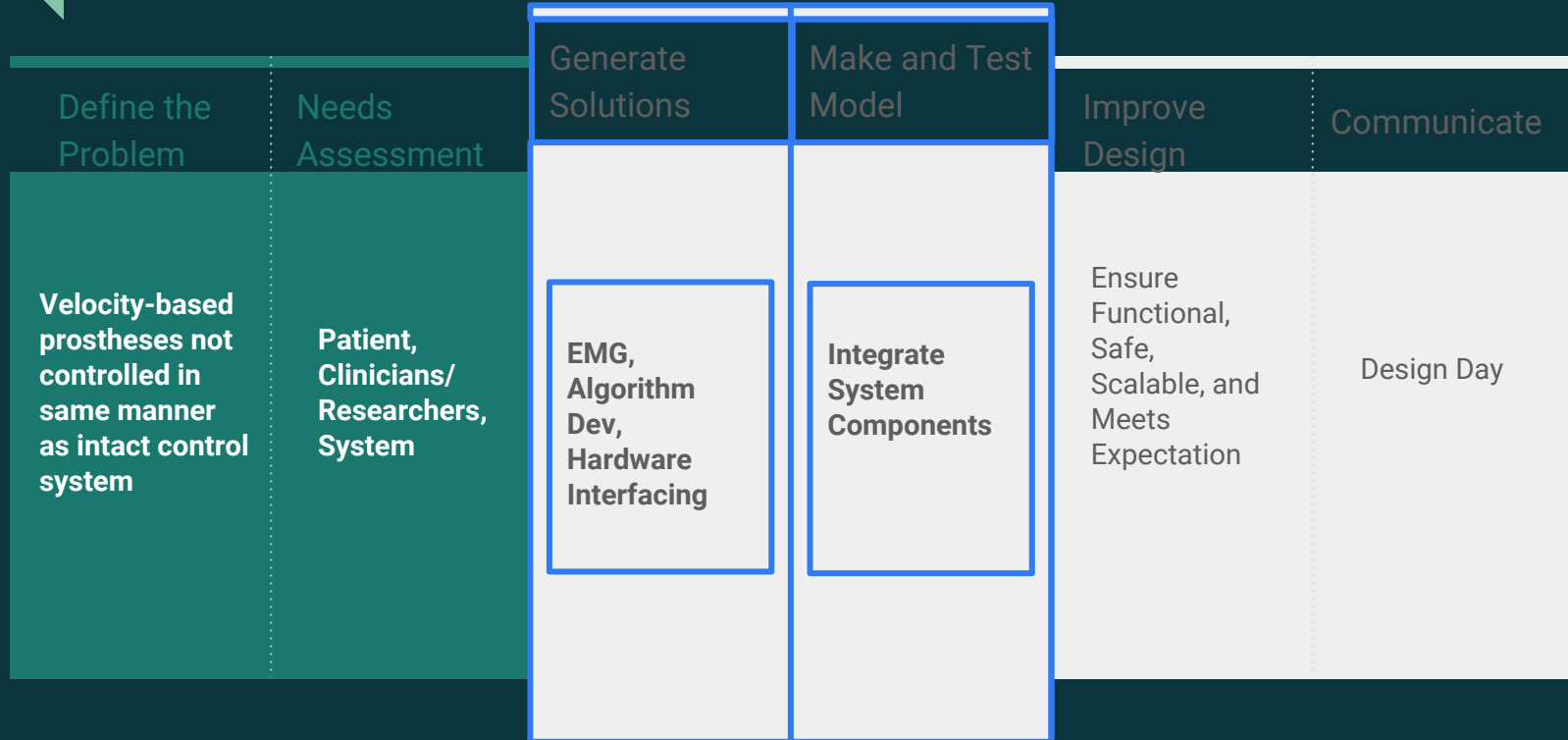



What Questions Do You
Have?



References

Slide 3,4 Figure A and B: Graczyk, Emily L et al. "Home Use of a Neural-connected Sensory Prosthesis Provides the Functional and Psychosocial Experience of Having a Hand Again" *Scientific reports* vol. 8,1 9866. 29 Jun. 2018, doi:10.1038/s41598-018-26952-x

Slide 10 Figure:

https://www.researchgate.net/figure/The-muscles-related-to-finger-motion-The-muscle-functions-are-as-follows-the-flexor_fig6_258378736

Slide 11 Figure: G. Tsenov, A. H. Zeghibib, F. Palis, N. Shoylev and V. Mladenov, "Neural Networks for Online Classification of Hand and Finger Movements Using Surface EMG signals," *2006 8th Seminar on Neural Network Applications in Electrical Engineering*, Belgrade, Serbia & Montenegro, 2006, pp. 167-171. doi: 10.1109/NEUREL.2006.341203

Slide 13: Battery Pack: https://www.adafruit.com/product/771?gclid=Cj0KCQiAm5viBRD4ARIsADGUT25Rn_FJLIYKc3t2rLc6H1FHcBdir39XMgxD5oLOFZC8Z59nZjuHMcMaApIDEALw_wcB Teensy Board: <https://www.adafruit.com/product/3266> Myoware Sensors: https://www.adafruit.com/product/2699?gclid=Cj0KCQiAm5viBRD4ARIsADGUT26WdiQrva9o_F5tG6X3-FNKWbrwMby-7y-6VrE-zYzJ9XYoIqbCTy8aAmcBEALw_wcB



Appendix



Needs Assessment: Patient

- Comfortable with no extra adjustments needed for the socket
 - Easily adapted to the patient's already customized socket
- Adjustable for different patients
 - Brand/type of prosthetic
 - Amputation type
 - Muscle capabilities
- Ease of Use
 - Minimal learning curve
- Easily donned and doffed
 - Electrode placement and wearable components should be as broad and simple as possible
 - The user should be able to apply and remove the system by themselves
- Psychological Effect
 - Consider psychological effects of using a removable device



Needs Assessment: Patient

- **Wearable**
 - Processor either in sleeve above the prosthesis or incorporated into the prosthesis itself
 - Must be tolerable weight for daily use
- **Safety**
 - Must be designed and built according to quality standards to ensure there are no safety hazards from the mechanical or electrical components
 - Must integrate ability to turn off in emergency situations
- **Cost-Effective**
 - Components used should be cost-effective to create an inexpensive and easily accessed solution for all users



Needs Assessment: Clinician/Researchers

- Easy access for parameter manipulation
 - If the design requires manual manipulation of electrode setting given amputation or manipulation of muscle activity parameters, a user friendly interface should be created.
- Speed of EMG to prosthesis actuation
 - Should optimize the translation of a captured EMG signal to corresponding prosthesis posture to provide accurate modeling of an intact hand
- Motor control testing functionality
 - Easy integration into lab testing environment with common motor control experiments
- Software and Design Documentation
 - Research Auditing
 - Data and results from the clinical experiments being run can be published
- Clinical Trial Regulations
 - Data output and patient regulations must be considered since device is to be used in clinical trial setting



Needs Assessment: System

- **Durable**
 - Daily use will require durability in different environmental conditions and during general activity
- **Integration**
 - Must integrate seamlessly with implanted neuromodulated sensory feedback system in users
 - Should minimize noise interference with implanted neuromodulated sensory feedback system and other devices
- **Scalable**
 - Solution should be applicable to any commercial OttoBock myoelectric prosthesis with minimal modification required
- **Biomimetic**
 - Natural hand-posturing created by overriding required velocity-based prosthetic inputs



Possible Prosthesis Movement/Position

Current Velocity-Based Systems

Muscle Group 1
Contraction

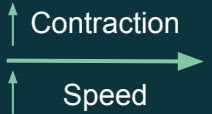

Flexion



Palmaris Longus
Contraction

Cease Muscle
Contraction



Maintenance of
Flexion



Continued Palmaris
Longus Contraction

Muscle Group 2
Contraction

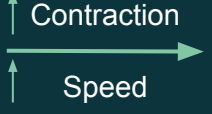

Extension

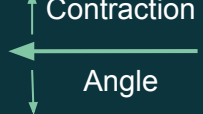

Extensor Digitorum
Contraction

Cease Muscle
Contraction



Maintenance of
Extension

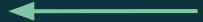

Continued Extensor
Digitorum Contraction

Activate Respective
Muscle Group and
Return to Neutral

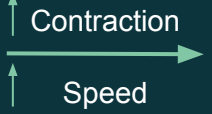

Relaxed Posture

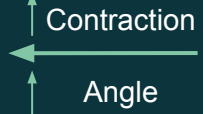

Cease all Muscle
Contraction

Proposed Force-Based System

EMG Signal Interpretation

- To do this, Root Mean Square calculates the mean power of the signal, mean absolute value calculates contraction level, and waveform length shows the cumulative length of the waveform

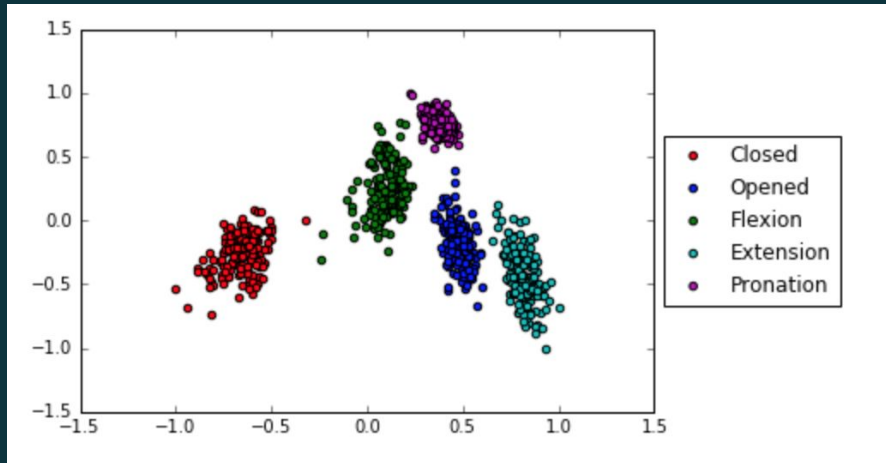

$$RMS_k = \sqrt{\frac{1}{N} \sum_{i=1}^N x_i^2}$$

$$MAV_k = \frac{1}{N} \sum_{i=1}^N |x_i|$$

$$WL_k = \sum_{i=1}^{N-1} |x_{i+1} - x_i|$$



Wearability/Durability

- Watch-like
attachment to socket
- Cardboard Prototype
- Adjustability
achieved with watch
strap