

THE ECLIPSE BALLOONING PROJECT AT VANDERBILT UNIVERSITY
AND THE CONSTRUCTION OF CUSTOM EQUIPMENT

By

Adam Jarrell

Thesis

Submitted to the Faculty of the
Graduate School of Vanderbilt University
in partial fulfillment of the requirements
for the degree of

MASTER OF SCIENCE

in

Mechanical Engineering

December 16, 2017

Nashville, Tennessee

Approved:

Professor Alvin M. Strauss

Professor George E. Cook

ACKNOWLEDGMENTS

I would like to thank all of my lab mates Devany Sweitzer, Jacob Matthews, Jay Reynolds, Kelsay Neely and, Todd Evans for being the launch and recovery crew for many long launch days. Also, I would like to thank Dr. Tim Holman, Bruce Martin, Robin Midget, Daniel Vibert, and the other members of the Vanderbilt Amateur Radio Club for providing vital experience and time into developing the amateur radio repeater. Additionally, they provided the APRS unit and the Microhunt beacon.

I would like to thank the Vanderbilt Grounds Crew for going above and beyond the expectations to recover balloons, where ever they landed. Additionally, Tom Delker, and the DeKalb County Amateur Radio Club for making eclipse day recovery much easier than previous launches.

I would like to acknowledge the efforts of the Montana, Minnesota, Colorado, and Louisiana Space Grant Consortium who provided guidance and developed the common payload utilized in this project.

Financial support was provided through the NASA Space Grant Consortium and Vanderbilt University.

TABLE OF CONTENTS

	Page
ACKNOWLEDGMENTS	ii
LIST OF TABLES	v
LIST OF FIGURES	vi
TERMS AND DEFINITIONS	xi
1 INTRODUCTION	1
1.1 The Eclipse Project	2
2 GENERAL GUIDELINES FOR HAB	5
2.1 APRS Tracking	7
3 HARDWARE OVERVIEW	11
3.1 Balloon and Parachute	11
3.2 Ground Station	13
3.3 Packages	14
3.3.1 Iridium tracking package	16
3.3.2 OCCAMs Cut Down Unit	17
3.3.3 Video System	18
3.3.4 Still Image System	19
3.3.5 Two Meter Beacon	19
3.3.6 APRS Unit	20
3.3.7 Environmental Package	21
3.3.8 Amateur Radio Repeater	23
4 SOFTWARE OVERVIEW	31
4.1 Ground Station	31
4.1.1 Video Streaming Computer	32

4.2 Packages	33
4.2.1 APRS unit	33
4.2.2 Environmental Package	34
5 LAUNCH LOGISTICS	39
6 FIRST TEST FLIGHT	41
7 SECOND TEST FLIGHT	45
8 ECLIPSE FLIGHT	47
9 LESSONS LEARNED AND FUTURE IMPROVEMENTS	50
10 CONCLUSIONS	54
BIBLIOGRAPHY	55
Appendix	56
A STANDARD OPERATING PROCEDURES FOR LAUNCH	56
A.1 Ground Station and Iridium Tracker	57
A.2 Still Image Package	58
A.3 Video Payload	59
A.4 Environmental Package	60
B ENVIRONMENTAL DATA	62
B.1 Heading	62
B.2 Temperature	66
B.3 Humidity	68
B.4 Pressure	69
B.5 CO_2	69

LIST OF TABLES

Table	Page
2.1 Budgetary guidelines for a basic HAB launch.	5
2.2 Comparison of the some of the trackers available to use with High Al- titude Balloonists	6
3.1 Materials used in the construction of the Environmental Package. . . .	23
3.2 Materials used in the construction of the Amateur Radio Repeater. . .	24

LIST OF FIGURES

Figure	Page
1.1 Path of totality of the August 2017 Solar Eclipse with lines indicating the magnitude of the eclipses and the time of maximum eclipse. Image produced by NASA's Scientific Visualization Studio and Ernie Wright [7].	3
1.2 Path of the August 2017 solar eclipse overlaid with the location of Eclipse Ballooning Project Teams' launch locations. [8]	4
2.1 Map of the VHF frequency reserved for APRS transmissions. [15]	8
2.2 Path that an APRS packet would take using the WIDE2-2 path.	9
3.1 How all the balloons used in the test launches were rigged. On an actual launch a second cable tie would be used, and the whole assembly wrapped in duct tape. The parachute and packages were suspended from the loop in the nylon cord.	12
3.2 The Diagram shows the connection and type of connection made between all components in the standard payload [8].	13
3.3 The Diagram shows the connection and type of connection made between all components in the standard payload.	14
3.4 The more rigid enclosure made to house the electrical components. The rigging lines run up the vinyl tubing around the package. The electronics are safely nested inside the enclosure.	16
3.5 General lay out of components inside of one of the cardboard tubes. The batteries were generally insulated by foam on all sides.	17
3.6 The Iridium tracking package deconstructed with major component labeled.	18

3.7	The live video package deconstructed with major components labeled.	25
3.8	The still image package deconstructed with major components labeled.	26
3.9	The Tracksoar unit bought to replace the APRS package lost in the first test flight [18].	27
3.10	Block diagram of the components of the environmental package. The sensors are arranged by what bus on the Raspberry Pi to which they are connected.	27
3.11	The environmental package deconstructed with major components labeled.	28
3.12	Schematic of the printed circuit board that was manufactured in house to connect the power distribution, sensors, and Raspberry Pi.	28
3.13	Block diagram of the components of the amateur radio repeater package.	29
3.14	Diagram of the repeater relay used to enable easy access to the balloon repeater.	29
3.15	The calculated radio horizon of the amateur radio repeater for various balloon altitude.	30
6.1	The flight path of the balloon during the second test flight on June 20th, 2017. The balloon landed in Riddleton, TN.	41
6.2	The two flight paths of the balloon and the lost APRS package.	42
7.1	The flight path of the balloon during the second test flight on August 8th, 2017. The balloon landed in Watertown, TN.	45
7.2	Video Still from the max altitude that the balloon reached. The Image was taken right after the balloon ruptured.	46
8.1	Image taken by the balloon at 7500-8000 meters as totality came into Nashville.	48

8.2	The flight path of the balloon during the second test flight on August 21st, 2017. The balloon landed in Statesville, TN.	49
8.3	Image taken by the balloon at 22,000 meters, near the maximum altitude of the eclipse flight.	49
9.1	Comparison of the flight paths of the two test flights and the eclipse flight.	52
A.1	Order that the packages were hooked up to the balloon. The Diagram was posted at all launches, so volunteers knew how to hook up their designated package.	56
B.1	The (a) longitude and (b) latitude plotted against altitude for the 08/08 flight. The different currents of air can be clearly seen by when the balloon changes direction. A large majority of the balloons movement is in longitudinal directions.	63
B.2	The (a) longitude and (b) latitude plotted against altitude for the 08/21 flight. The different currents of air can be clearly seen by when the balloon changes direction. A large majority of the balloons movement is in longitudinal directions.	63
B.3	The derived wind (a) speed and (b) bearing plotted against altitude for the 08/08 flight. The different currents of air can be clearly seen by when the balloon rises above a defined altitude.	64
B.4	The derived wind (a) speed and (b) bearing plotted against altitude for the 08/21 flight. The different currents of air can be clearly seen by when the balloon rises above a defined altitude.	65
B.5	The (a) ascent and (b) descent rate of the balloon derived from the altitude data of the balloon.	65

B.6	Temperature reported by all the sensors on board the environmental logger during the the 08/08 test flight during (a) ascent and (b) descent.	66
B.7	Temperature reported by all the sensors on board the environmental logger during the the 08/21 test flight during (a) ascent and (b) descent.	66
B.8	Comparison of the temperature measured from the Type K thermocouple for both the 08/08 and 08/21 flights for (a) ascent and (b) descent. It can be easily seen that the thermocouple on the 08/08 flight was lose in the socket and fell out around 15000 meters.	67
B.9	Temperature measured by the Type K thermocouple during the 08/08 flight for ascent and descent.	68
B.10	Temperature measured by the Type K thermocouple during the 08/21 flight for ascent and descent.	69
B.11	Comparison of the humidity measured from the SHT31 IC for both the 08/08 and 08/21 flights for (a) ascent and (b) descent. The accuracy of the data above 1000 meeter and during decent is doubtful due to the sensor being below temperature limits.	70
B.12	Humidity measured during the 08/08 flight for ascent and descent. .	71
B.13	Humidity measured during the 08/21 flight for ascent and descent. .	72
B.14	Comparison of the pressure measured from the BMP180 IC for both the 08/08 and 08/21 flights for (a) ascent and (b) descent. The range of the measured pressure is within the bounds of expected.	72
B.15	Pressure measured during the 08/08 flight for ascent and descent. . .	73
B.16	Pressure measured during the 08/21 flight for ascent and descent. . .	74

B.17	Comparison of the CO_2 measured from the K-30 IC for both the 08/08 and 08/21 flights for (a) ascent and (b) descent. The k-30 seems to have malfunctioned for a majority of the of the 08/08 flight. The reasons are unknown However, descent data is questionable due to the rapid rate of descent.	74
B.18	CO2 measured during the 08/08 flight for (a) ascent and (d) descent.	75
B.19	CO2 measured during the 08/08 flight for (a) ascent and (d) descent.	75

TERMS AND DEFINITIONS

APRS - Automatic Packet Reporting System is a HAM Based digital communications system

Arduino - Arduino is an open source single-board microcontroller and accompanying programming language based off C.

ARIES - ARIES is the Montana State University based server dedicated to retrieving and distributing telemetry through the Iridium Satellite Array

EEPROM - Electrically Erasable Programmable Read-Only Memory is a method of data storage that allows byte level read, write, and erase of bits. It is commonly used on microprocessors to store configurations.

FFmpeg - FFmpeg is a open source project that produces multimedia programs.

GPIO - General Purpose Input and Output are general purpose pins, who's function are controlled by the user.

GUI - The Graphical User Interface is the portion of the program that interfaces with the user.

HAM radio - The use of dedicated radio frequency bands for non-commercial private recreation.

I²C - Inter-Integrated Circuit is a three wire synchronous serial interface.

IMU - Inertial Measurement Unit is a electronic device designed to measure 3D orientation. The device includes an accelerometer, gyroscope, and magnetometer.

Iridium Satellite Array - The Iridium Satellite Array is an constellation of 66 active satellites to provide phone and data coverage over Earth's surface.

OBS - Open Broadcaster Software is a open source video recording and streaming software.

OCCAMS - The cutdown unit from the standard payload. Named after Occam's Razer.

Python - Python is a general purpose scripting language that is easy to use and popular in scientific communities.

Raspberry Pi - Raspberry Pi is a single-board computer based around a ARM processor and Debian Linux Operating System.

Raspberry Pi Zero W - The Zero W is the latest model of the Raspberry Pi. It is a small form factor computer with wireless capabilities.

Shell Script - program that is designed to be run by a command-line interpreter.

SPI - Serial Peripheral Interface bus is a four wire synchronous serial interface.

UART - Universal Asynchronous Receiver-Transmitter is an asynchronous serial interface.

UHF - Ultra High Frequency is the range of the radio spectrum from 300 Mhz to 3 Ghz

UTM Coordinates - Universal Transverse Mercator coordinate system

VHF - Very High Frequency is the range of the radio spectrum from 30 Mhz to 300 Mhz.

VLC - VLC is an open source media player.

CHAPTER 1

INTRODUCTION

High Altitude Ballooning is an effective and relatively simple conduit for STEM education. Balloons provide a space-like environment and regularly reach the stratosphere with sustained flights. Latex balloons have flight times measured in the hours, and mylar "zero pressure" balloons can maintain an altitude for months. The budget for a launch can range from hundreds to millions of dollars. At the minimum, high altitude balloons use around 400 dollars of consumable materials per flight, and their payloads can be as simple as a few sensors with a single board computer and a tracking device. At the maximum, they can be used for millions of dollar research projects.

High Altitude ballooning has a low barrier to entry into the field and is commonly done with students as young as elementary age. Cheap and simple experiments can be developed, using single board computers, for grade school to enhance the educational experience [1]. Students can get first hand experience in the use of the scientific method. They can formulate real world questions, hypothesize about the results, develop experiments, conduct the experiments, and formulate conclusions. High altitude ballooning can provide a teaching platform that will make an impact in the students education.

In comparison, rocketry and CubeSat programs are rarely seen outside of the large university environment. Rockets have safety concerns with explosive fuels, and require large amounts of expertise. Additionally, they go to a lower altitude for less time than balloons. CubeSats represent a large investment, on the order of tens of thousands of dollars, and require specialized equipment to survive the radiation environment in a low earth orbit. Generally, they are inaccessible to anyone without

specialized engineering experience.

Even though High altitude ballooning is accessible for inexperienced teams, ballooning can also provide real world solutions and be a platform for large scale research projects. The National Weather Service launches hundreds balloons daily from their weather stations to gain information on wind patterns in the upper atmosphere [2]. Large balloons were used to carry the BOOMERanG used to map the cosmic background radiation around the south pole [3]. Google Lune is experimenting with balloons to provide affordable Internet to undeveloped regions by using steerable balloons to create an in air network of Antennas to distribute Internet to those bellow [4]. NASA has long used ballooning to create analog extraterrestrial environments in which to conduct experiments. [5] [6].

1.1 The Eclipse Project

August 21st, 2017 a total solar eclipse was predicted to transverse coast to coast across the county. Totality was to enter the United States from the Oregon coast line and depart off the South Carolina coast. Twelve states would experience totality, Figure 1.1. The last total solar eclipse in the continental United States was in 1979, and only crossed the northwestern section of the country.

It was believed eclipse would be an excellent opportunity to capture the imagination of everyone, regardless of education level. The Eclipse Ballooning Project was a NASA Space Grant Consortium initiative created harness the interest behind the eclipse as a conduit between educators and the general public for STEM knowledge. It was also used as an opportunity for students to get hands on experience with being part of a national collaborative project. The main feature of the project was coast to coast coverage of the eclipse filmed from high altitude balloons.

The August 2017 eclipse provided an excellent opportunity to attempt a national collaborative project as the eclipse covered the entire Continental United States. The

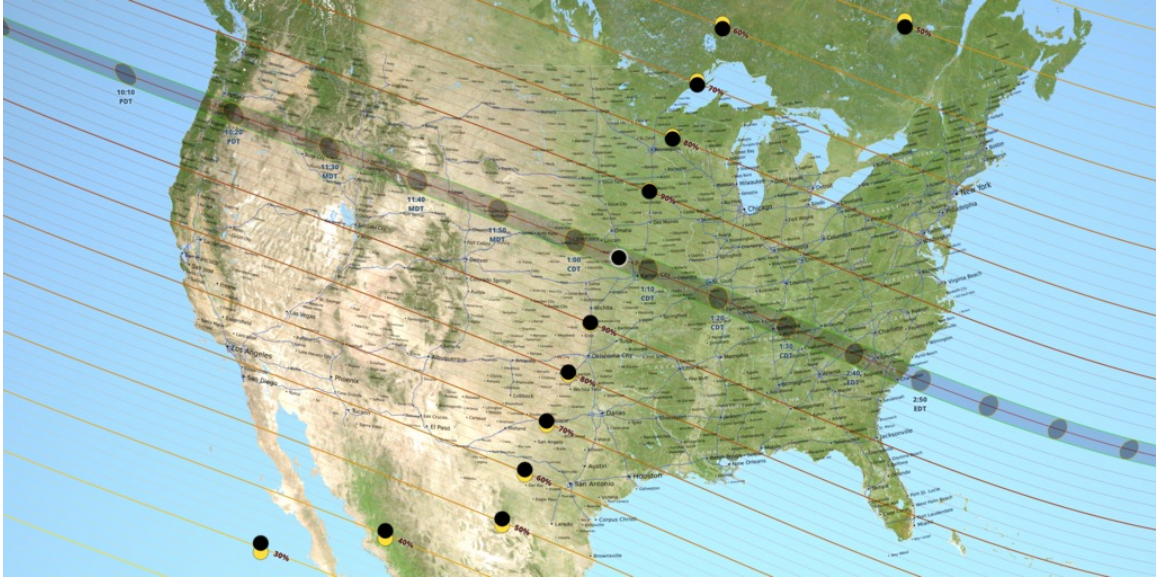

Figure 1.1: Path of totality of the August 2017 Solar Eclipse with lines indicating the magnitude of the eclipses and the time of maximum eclipse. Image produced by NASA’s Scientific Visualization Studio and Ernie Wright [7].

Eclipse Ballooning Project was a collaborative effort on a larger scale than had been previously attempted by the Consortium. 52 teams from 30 different states were involved in the project. Teams launched from 25 locations across the total eclipse path, Figure 1.2. 8 Teams from High Schools, 8 Teams from Community Colleges, 4 Ballooning Groups, and 40 universities took part in the project [8].

Outreach and media coverage was a large part of the project. Each opportunity to be out in front of the public was an opportunity to educate. The project was used to communicate planetary science, atmospheric science, radio communication and more to the general public. Lesson plans were created for grade schools [9] [10] [11]. A public website was created to house all of the eclipse steams [12].

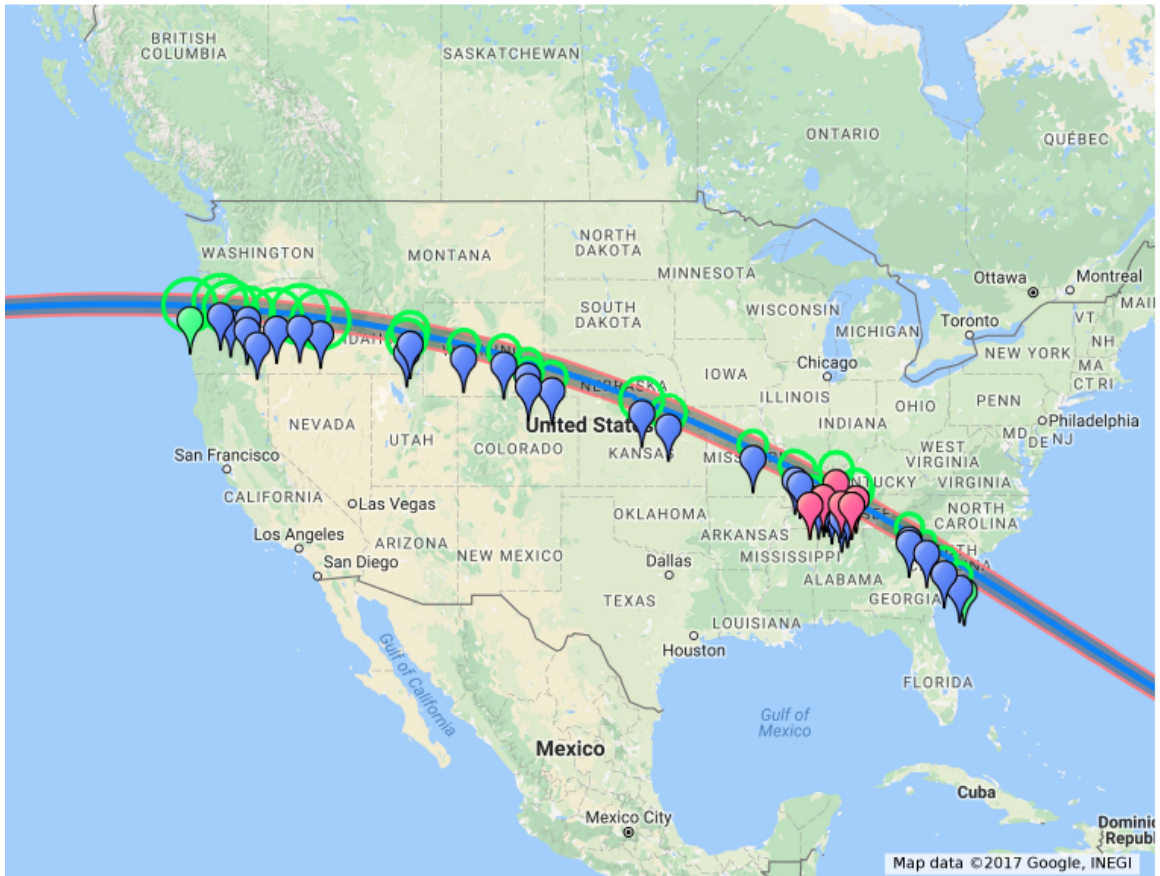

Figure 1.2: Path of the August 2017 solar eclipse overlaid with the location of Eclipse Ballooning Project Teams' launch locations. [8]

CHAPTER 2

GENERAL GUIDELINES FOR HAB

High Altitude Ballooning is a low budget platform of accessing a space like environment. When planning a launch there are a few general guidelines to follow.

At the low end, a latex balloon launch will only cost 230-580 dollars in expendable materials. A single balloon can typically carry multiple packages in its payload. A package is a self contained set of hardware designed to fulfill a task. Generally, each package is placed in its own container as suspended in a stack under the balloon. A general budgetary guideline is written out in Table 2.1. The exact cost of the a HAB launch will depend on the packages that are used as well as the research goals of the launch. The budget listed only accounts for a single packages but one balloon can carry multiple payloads.

Material	Cost
Consumables	
Balloon	100-250
Helium	100-300
Rigging	30
Tape and other Launch Supplies	50
Non-consumable	
Parachute	50-100
Balloon Filling Equipment	30
Regulator for helium	40
Tools	100
Packages and Instrumentation	200
Tracker	200-300
Total	900-1400

Table 2.1: Budgetary guidelines for a basic HAB launch.

The FAA regulates unmanned freed balloons in Part 101 Subpart D of the FAA regulations. The regulations will not be listed here due to upcoming changes in the

regulations. Refer to the regulations to insure that regulations are followed [13]. All flight restrictions, notification requests, and balloon requirements should be followed for each launch.

Any balloon that is expected to be recovered needs to have some device capable of providing locational telemetry back to the ballooning team. The device is usually called a tracker. A reliable tracker is especially important when data from the balloon needs to be related to altitude. Some of the tracking devices readily available to the balloonist are compared in Table 2.2.

Tracker	Advantages	disadvantages	Cost
Spot tracker	Reliable and regularly tested. Popular option for hobbyist ballooning. Wide international coverage	Requires a subscription fee. Not modifiable. Low operating Altitude. Difficult to obtain raw data.	170 + 15 a month
Iridium	Reliable. International coverage. Commercial Solution. Raw data can be requested from the Iridium Database. Models are available without altitude limits. Can be used for two way communication.	Requires subscription fee. Requires data fee. Expensive.	600 + 10 a month + data fees
APRS	No subscription fees. Easy access to raw data. Easily modifiable. Models are available with out altitude limits.	Coverage isn't universal and depends on hobbyists. Requires a license to operate.	100 to 300

Table 2.2: Comparison of the some of the trackers available to use with High Altitude Balloonists

Trackers that haven't been proven or reported by a reliable source to be effective in high altitude scenarios shouldn't be depended on. Some GPS modules have been programmed to be ineffective at high altitudes or speeds obtainable at higher altitude. If you are validating one brand of GPS module, pair it with another that is reliable.

Redundant reliable trackers should be used and placed on opposite ends of the packages stack to be assured of recovery. If possible, use trackers that use two different communication methods. For example, Iridium systems use a satellite array for communication, and APRS depends on a network of ground stations. If the balloon fragments in two, both fragments will have a tracking system for recover. If the balloon doesn't transmit all collected data through telemetry systems, recovery of the packages is essential for success of the launch.

When rigging up the package stack, insure that the packages have enough room between them to prevent interference. This can be in the form of radio interference, or disruption of the environment the package is designed to measure. packages can interfere with each other electrically, disrupting transmission and function Interference can be minimized by increasing the amount of line between each package, minimum of 6 feet between packages, and thoughtful selection of order.

2.1 APRS Tracking

APRS is a remote telemetry reporting systems developed by HAM operators, and it requires a HAM license to use. APRS, Automatic Packet Reporting System, network is commonly used to track high altitude balloons. The network can be used to relay locational, altitude, and some sensor data to the ground. Since it is relatively open software and hardware, it warrants some explanation here.

The networks consists of three components. Automated beacons that broadcast digital telemetry packets. Specialized repeaters, called digipeaters, rebroadcast the digital packets. Internet connected radios, Igates, upload the digital packets to central servers. Digipeaters are high powered devices and are placed in areas that provide the best reception. However, they tend to be remote and lack an Internet connection. Igates can be run by HAM clubs or individuals. These centralized servers can be accessed and telemetry of the beacon can be received on the ground via specialized

websites [14].

A frequency of the VHF band has been set aside for use with APRS. The specific frequency varies per country; in the United States, 144.390 MHz has been set aside for APRS, Figure 2.1.

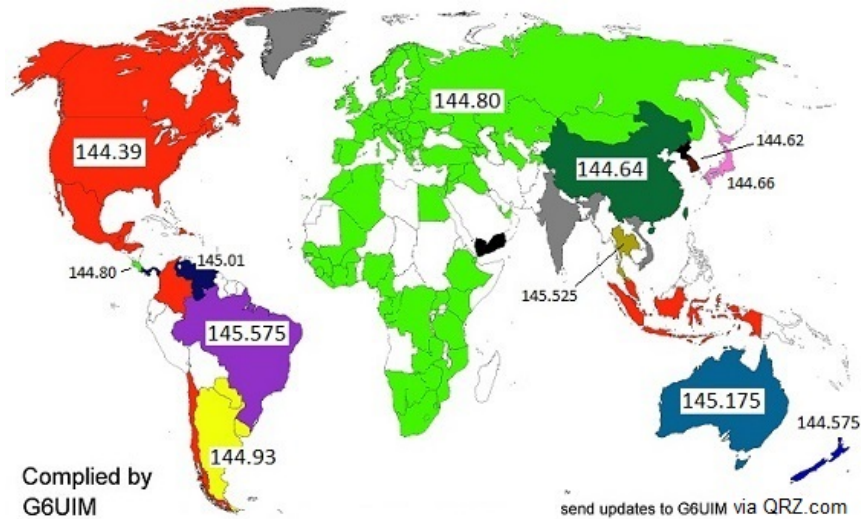

Figure 2.1: Map of the VHF frequency reserved for APRS transmissions. [15]

The idea is that the beacons broadcasts the packets in direct range of an Igate, or the packet "hops" digipeaters; the digipeaters rebroadcast the packet with greater power to be heard by an Igate. The number of hops the packet is to take is preprogrammed into the packet. The packets are broadcast by the beacon and digipeater without feedback of receipt So, the packet will continue to make the full number of hops regardless of when and where it was received by an Igate.

APRS is a public and largely unregulated service. Therefore, there is the ability to abuse the service. The digital packets contain no error correction. The entire packet must be received without errors if it is to be received at all. So, every transmission has to have completely clear airways. Any noise or interference prevents reception of the signal. So, APRS depends on each packet being transmitted in its own time slot.

Modern improvements to the system attempt to prevent the abuse of the system. For example, digipeaters don't retransmit packets from the same call sign within a

specified time, and digipeaters toss out packets that are coded for too many hops. Most digipeaters restrict the number of hops to two to restrict the amount of traffic on the network. The digipeaters either ignore any packet designating more than two jumps or modify the packet. However, the responsibility for not clogging up the network is still upon the user. So, the networks allows for several transmission modes depended on the use case to avoid clogging up the network.

The header of APRS packages contain the call sign of the recipients and sender. The recipient can be a specific station or general class of devices. The recipients are placed in order to designated the path the packet is to take. All relatively new APRS devices follow the WIDEn-N pathing paradigm. Most home stations respond to the Wide1-1 call sign. Digipeaters in the VHF band respond to the WIDE2-N call sign and decrement N by one as long as N is greater that zero, Figure 2.2.

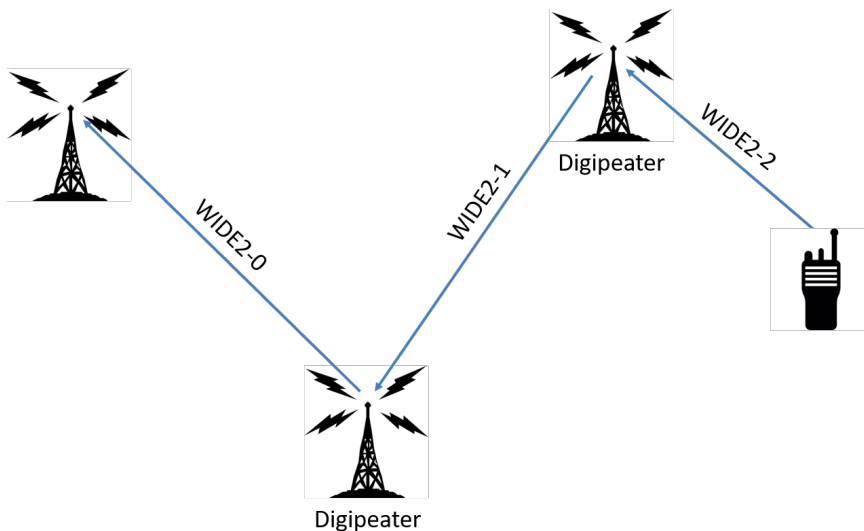

Figure 2.2: Path that an APRS packet would take using the WIDE2-2 path.

It is recommended that for high altitude operation to use the WIDE2-1. The identifier prevents home stations from digipeating the signal. At the altitude the APRS unit flies, hundreds of home stations could be accessed by the unit causing hundreds of identical packets to overflow the network. Digipeaters that received the APRS transmissions would only rebroadcast them once minimizing traffic. Transmitting

in a different mode would clog up the APRS network with access traffic making it unusable for hundreds of miles. Even without the digipeating function of the APRS network, the altitude of the balloon makes the likelihood of reaching an Igate with the first transmission almost a certainty [16]

CHAPTER 3

HARDWARE OVERVIEW

A majority of the hardware utilized in the Eclipse Project was provided through the Space Grant Consortium. Two of the additional packages were in-house solutions, and the additional tracking devices were commercial solutions configured for our needs. The provided hardware was designed to fulfill the minimum requirements of the project. The requirements were that the system had to be able to live stream video of the eclipse from above 60,000 feet with a maximum range of 30 miles, and to take still images through the flight. The FAA requested that all balloons in the air under this project had to be traceable by air traffic controllers, and each team had to provide a the option of termination of the flight in-case of conflicts of airspace.

A standard payload and ground system was developed to fulfill all of the requirements, and was distributed to all of the teams during a workshop. The ground station, live video payload, still image payload, and Iridium tracker, and the OCCAMs cut down unit were received. An environmental logger and amateur radio repeater were constructed in house to add to eclipse flight. An APRS tracker from Tracksoar was included to have a redundant tracker, and a 2 meter fox hunting beacon was purchased in case of emergency.

3.1 Balloon and Parachute

The balloon utilized for all launches was a Kaymont 2000g high altitude balloon. The latex balloon expands continually with the decreasing pressure, the bursting diameter is 10.5 meters. The balloons can take 7-9 pounds to 110,000 feet with ideal conditions.

The neck of the balloon was stiffened with a small length of 1.5 inch diameter

PVC tubing. This gave the balloon a rigid area to attach the rigging using cable ties, Figure 3.1. At least two cable ties were used to firmly fasten a loop of paracord to the balloon. Multiple loops of a duct tape were wrapped around the cable ties to prevent sharp ends from damaging the balloon.

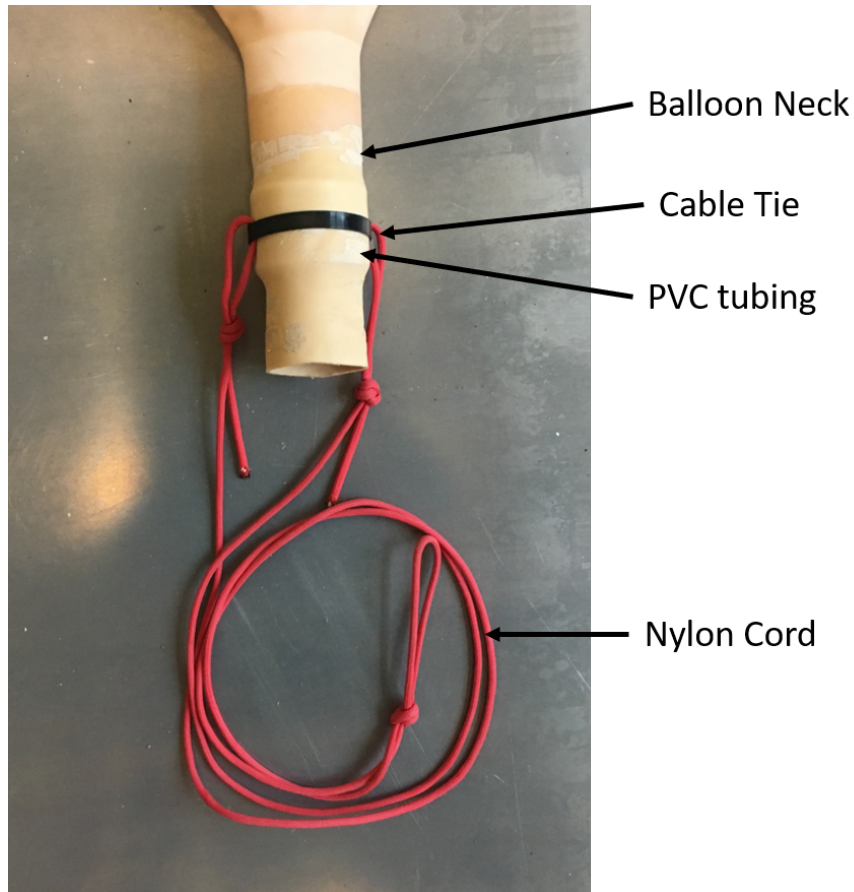

Figure 3.1: How all the balloons used in the test launches were rigged. On an actual launch a second cable tie would be used, and the whole assembly wrapped in duct tape. The parachute and packages were suspended from the loop in the nylon cord.

The parachute was a 72 inch Spherachute modified with a weather balloon attachment. The parachute is designed to give a 8-13 lbs payload a 15-20 ft/sec descent rate at sea level. The rate will insure that the packages or anything hit by the balloon are not damaged during decent.

The parachute was connected to the paracord loop from the balloon via a second length of paracord. The second length should be around 6-10 feet long. It prevents the

remnants of the balloon from partially or fully closing the parachute. The packages were suspended from under the parachute by a key ring connecting the suspension lines of the parachute.

3.2 Ground Station

The ground station encompassed all the video streaming and telemetry equipment, Figure 3.2.



Figure 3.2: The Diagram shows the connection and type of connection made between all components in the standard payload [8].

One dish antenna was used for the 5.8 GHz system. One patch antenna and one Yagi antenna was used for the 900 MHz system. The fixture for the antennas was constructed out of 80/20 extruded aluminum sections.

Since the antennas used are directional, have an asymmetric gain pattern, the ground station features a pointing system. The pointing system used a IMU to provide bearing and elevation data. An Arduino with an GPS shield was used to determine the ground stations location. The magnetometer was used for the bearing, and the accelerometer was used for the elevation. Tilt and pan servos were used to point the antenna array. A Pololu Micro Maestro Servo Controller was used to control the servos.

Connections made between the balloon payloads and components of the ground station is shown in Figure 3.3.

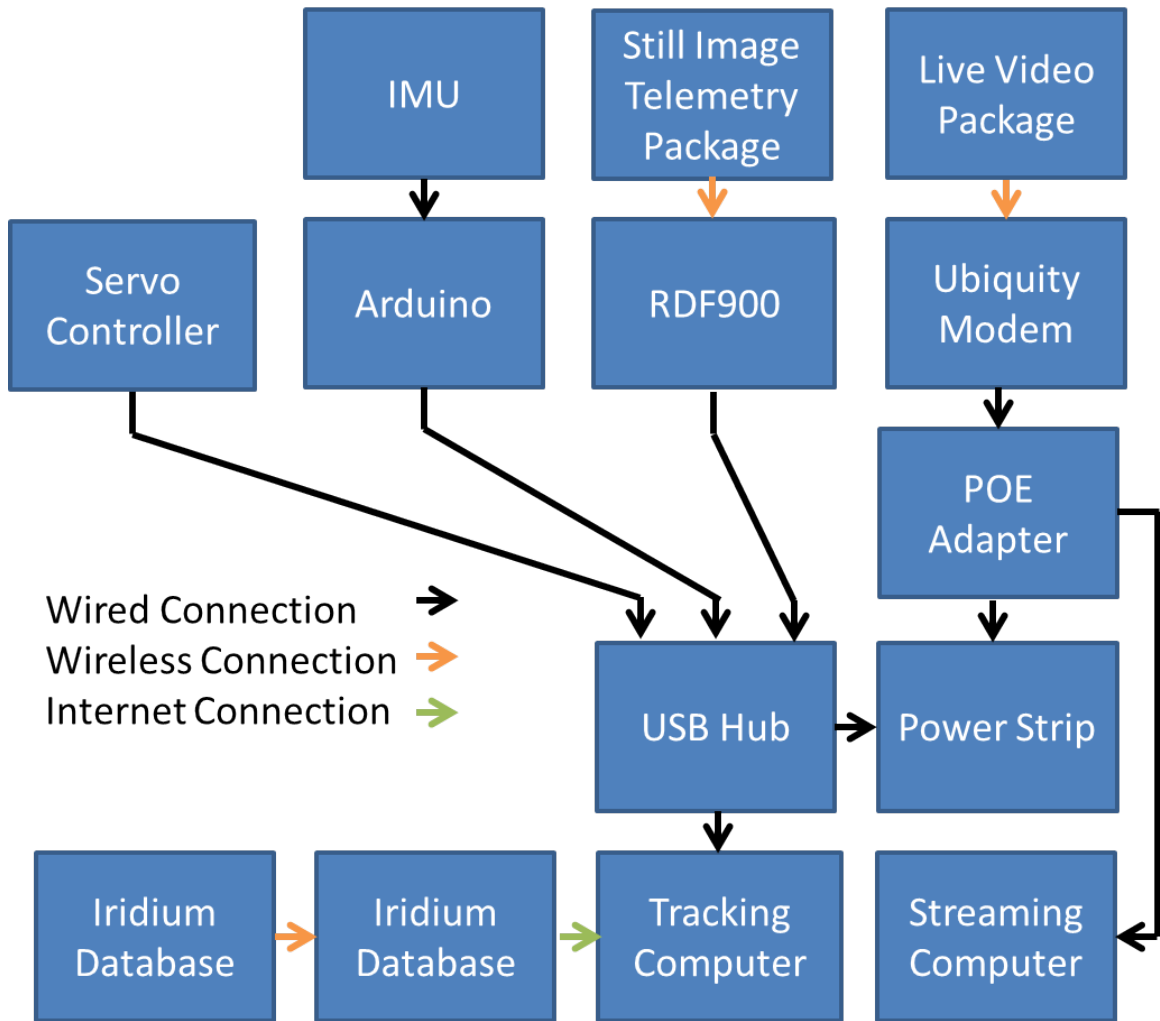

Figure 3.3: The Diagram shows the connection and type of connection made between all components in the standard payload.

3.3 Packages

All instrumentation is suspended underneath the balloon in packages. Each of the packages are designed for a purpose. For example, packages can provide locational telemetry allowing recovery teams to track the balloon or log the environment that the balloon transverses. Each of the packages must be built to be light but resistant

to water and protect the components inside against impact.

The original packaging provided with the standard packaging was replaced with a sturdier design due to concerns about insulation and water, Figures 3.4, 3.5. The design was inspired by the work of the Pittsburgh eclipse ballooning team and the Minnesota Space Grant. The containers were based around materials readily available from local vendors. The body of the packages were constructed from concrete form tubes. Four guide lines were routed on the outside of the concrete tube through vinyl freezer tubing at 90 degree angles with respect to one another. The tubing prevented the rigging from fraying or catching on the corners of the container, and causing a possible lost of a package. Tight fitting disks of extruded polystyrene rigid foam insulation seal off either end of the pip and are used to nest electrical components in layers inside. The components were secured together by mechanical means via zip ties. On each package, contact information was affixed to the outer surface of the package. Therefore, anyone who finds the balloon after the landing will be able to contact the team and return the packages.

The cardboard tubes are typically used for a form when pouring concrete columns. So, they are made out of a thicker material and have a waxy coating that resist water. They stand up well to moisture and are rigid enough to reliably connect the packages to each other. Additionally, they are easy to shape and form. The polystyrene foam served as an insulating material to prevent the packages from getting to cold to function in flight. It also served as a potential source for flotation in the case of a water landing.

Each package had approximately 10 ft of nylon twine run through each of the four vinyl tubes with key rings knotted to each end of the twine. The twine and key rings are intended to fail at 50 pounds per current FAA regulations. Each guide line was knotted on either side of the package such that the line could not slide through the tubing. The key rings are used to connect the packages together.

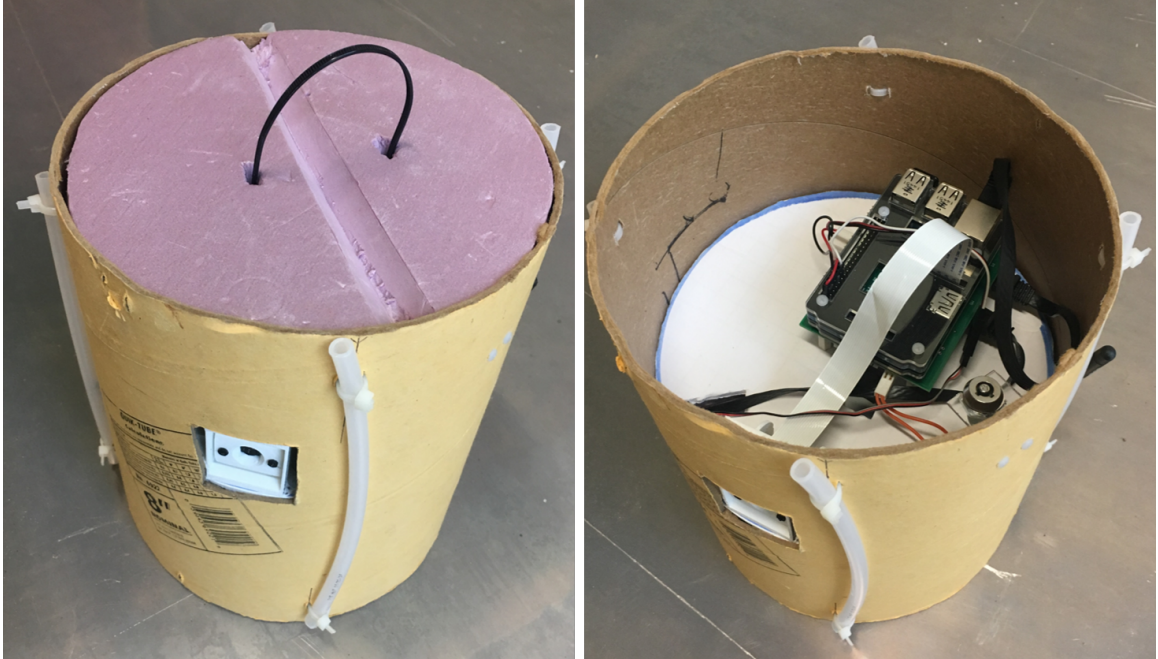

Figure 3.4: The more rigid enclosure made to house the electrical components. The rigging lines run up the vinyl tubing around the package. The electronics are safely nested inside the enclosure.

3.3.1 Iridium tracking package

The Iridium tracking package was the primary tracker of the balloon. The Iridium 9602-LP modem used was purchased from NAL Research Corporation. The modem is capable of two way communication with the Iridium Satellite array. The modem was connected to two patch antennas. One for the patch antennas receives transmissions from the GPS array, and the other communicates with the Iridium array. The system was powered by a 6600 mAh Lithium Ion Battery pack. A control board housed an Xbee Bluetooth module that connected to the OCCAMs cut-down unit. All of the components were attached to a 3d printed bracket and nested in a foam insulation ring, Figure 3.6.

Commands could be sent to Iridium modem. These would turn on individual pins on the 15-pin D-Sub connector. These signals are decoded by the control board and sent corresponding commands over the Xbee. Through this system, the flight could

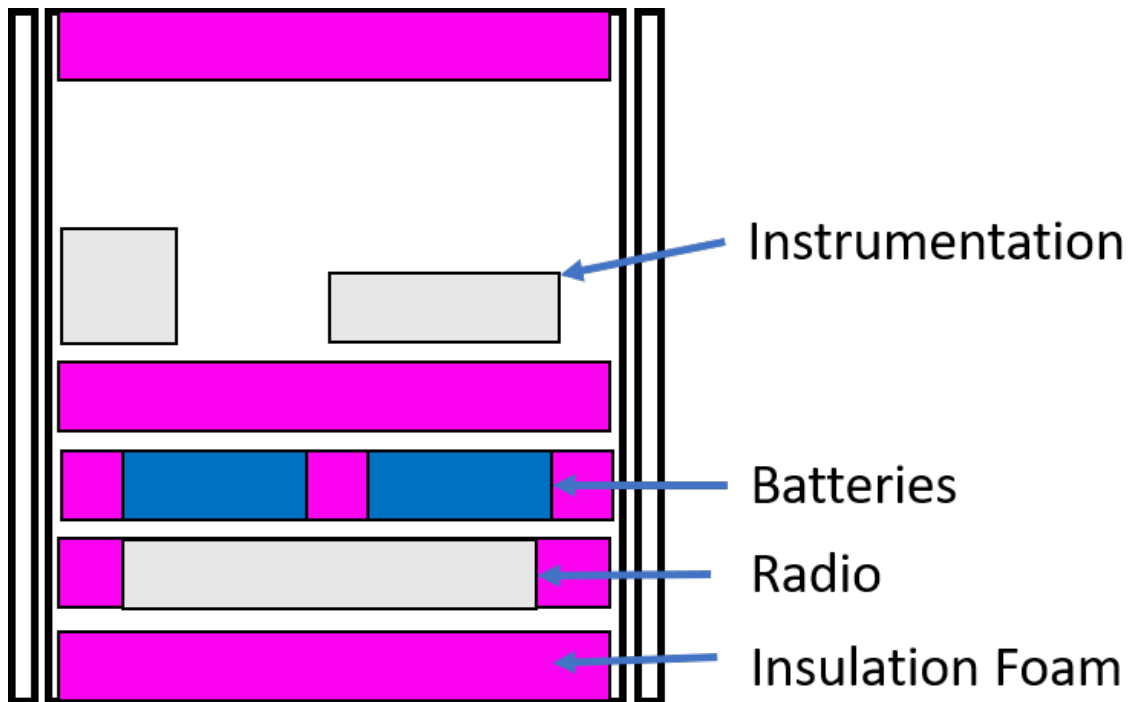

Figure 3.5: General lay out of components inside of one of the cardboard tubes. The batteries were generally insulated by foam on all sides.

be terminated at any time through the Iridium array.

The insulation disk housing the device was sandwiched between two other insulation panels and fitted into the cardboard tube.

The package was instrumental in pointing the ground station antennas. The ground station used telemetry data from the Iridium modem to position the antennas.

3.3.2 OCCAMs Cut Down Unit

The OCCAMs cut down unit could be used to terminate the flight by separating the packages from the balloon. The balloon would continue the flight while the packages would fall to the ground. The unit could be used to prevent the packages from landing in an inconvenient situation.

The cut down system was formed around a 3d printed frame. the line connected the balloon to the parachute ran through the 3d printed frame. An motorized offset

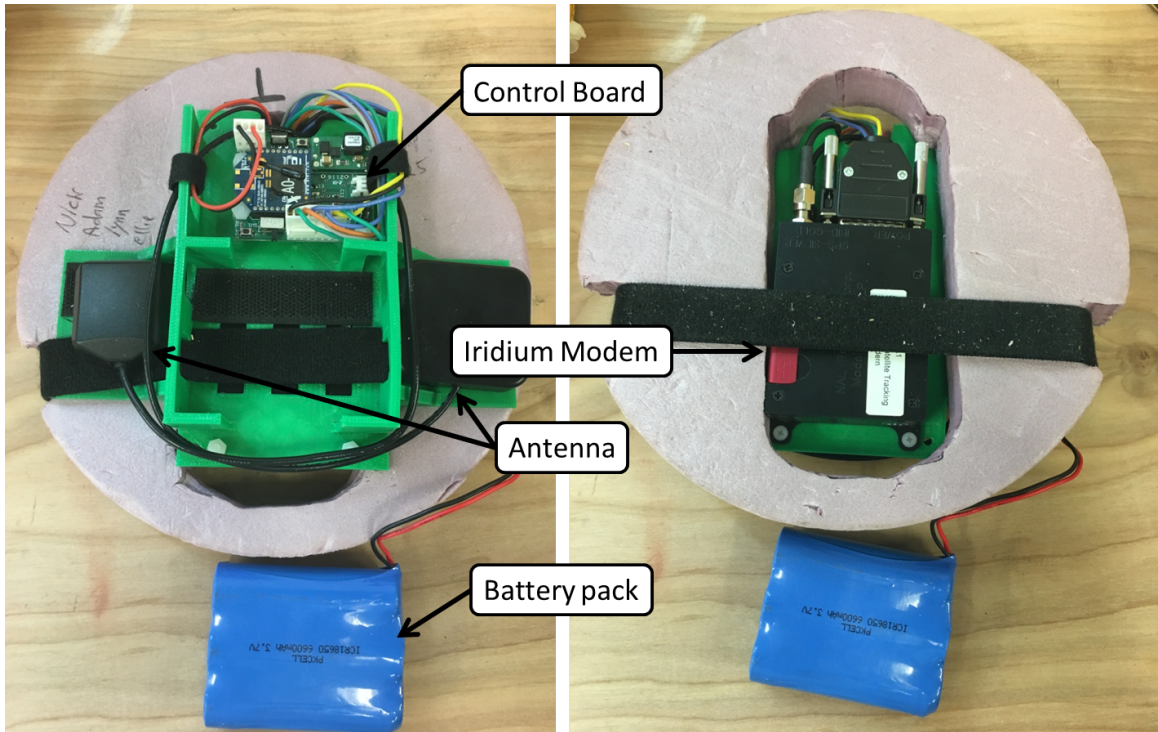

Figure 3.6: The Iridium tracking package deconstructed with major component labeled.

razer blade could be spun to cut the main line. There is a similar control board to the Iridium unit on OCCAMs. The Bluetooth module between the two units link up in air.

3.3.3 Video System

The video system was the main vehicle for outreach of the Eclipse Ballooning Project. The system was designed to allow live streaming from the stratosphere. The system was based on a Raspberry Pi 3. The Raspberry Pi interfaced with a 5 MP Pi camera and a M5 Ubiquity Modem. A custom built power board distributed power to the Raspberry Pi over the GPIO pins and the M5 Modem through POE. The modem used two 5.8 rubber ducky antennas. The camera was mounted in a 3d printed case that allowed for tilt adjustments. The case had an integrated tilt servo. The servo was not utilized for this project.

The unit was powered by two 6600 mAh Lithium Ion batteries. The batteries could provide about 2-3 hours of video streaming.

The raspberry pi and camera was mounted onto a foam core board, Figure 3.7. The modem and batteries were nested in foam insulation panels and stacked below the Raspberry Pi, Figure 3.5. The stack was then put into the standard tube enclosure. The antennas passed through the side wall of the enclosure.

3.3.4 Still Image System

The still image system was also a raspberry pi based system. The Raspberry Pi interfaced with a 5 MP pi camera.

The package utilized a 900 Mhz long range telemetry radio from RFDesign. The radio has a power rating on 1 watt and claims an operating range of greater than 40 km depending on operating conditions.

The package was powered by two 6600 mAh lithium Ion batteries. The system could operate for about 3 hours of flight time off the batteries.

The electronic components were mounted similar to the video system. The Raspberry Pi, Radio, and Camera was mounted onto a foam core board with the rubber ducky antennas mounted in a perpendicular polarization arrangement with an thin gauge steel ground plane. The batteries were enclosed in foam insulation. The stack of components were pressed into a cardboard tube and sealed off on both ends by more of the foam insulation.

3.3.5 Two Meter Beacon

A two meter fox hunting” beacon from microhunt was included on the payload [17]. The beacon transmitted on 146.565 MHz, and it repeated the call sign ”AA4VU” in Morse code for 30 seconds followed by a 30 second down time.

The beacon would be the last backup for tracking down the balloon via direction

finding efforts. If all tracking systems on the balloon failed. Then, a team can go out to the estimated landing location with a directional antenna and possibly hunt down the balloon.

3.3.6 APRS Unit

Two APRS units were used through the balloon flights. The first was a homemade solution. It was lost during the first test flight, when the package broke free during balloon burst.

The second was a unit from Tracksoar, a super light APRS unit developed at the Santa Barbra Hackerspace [18]. The Tracksoar was based off of an Arduino. It is programmable through the Arduino IDE, and the unit is completely open source. Powered from 2 AA batteries, the unit transmitted on the 2 meter band, 144.390 MHz, through a dipole antenna.

The Tracksoar unit also incorporated a BMP280 humidity and pressure sensor. The BMP280 includes a low noise temperature sensor that is primarily used for temperature correction of the pressure and humidity. Additionally, the BMP 280 isn't rated for temperatures below -40 C, so the accuracy its operation in the upper troposphere is questionable.

The Tracksoar unit was nestled between two foam insulation sheets, and fitted into a small diameter cardboard tube. The dipole antenna was threaded out of the tubing and affixed to a fiberglass reinforced plastic rod.

The unit had very good performance with two Lithium Ion AA batteries. It survived the altitude and transmitting for two days straight, which was plenty of time to find the package after landing.

3.3.7 Environmental Package

The environmental package was based on a Raspberry Pi Zero W. Environmental Sensors are populated on the I^2C , SPI , and UART buses of the Pi. MCP9808 temperature sensor, SHT31 humidity sensor, BMP180 pressure sensor, and DS3231 real time clock populated the I^2C bus. A Max31856 universal thermocouple amplifier populated SPI bus. The K-30 10,000 PPM CO_2 sensor interfaced with the UART bus, Figure 3.10.

All of the sensors used in the package was provided as breakout boards. So, the focus of the project could be spent on interfacing with the sensors instead of design and manufacture of an appropriate PCB with individual components. The breakout board were purchased through Adafruit and CO2Meter.com

The Raspberry Pi Zero W was selected so that the Pi can be configured as a wireless access point. The accesses point can be used to verify operation prior to launch, and the files can be retrieved via SSH file transfer after the launch. Additionally, The Pi had an extremely low power draw, around 300 mA at full operation.

The package initially intended to only utilize A SHT31-D humidity sensor, MCP9808 temperature sensor, and the BMP180 pressure sensor, and the K-30 CO_2 meter. However, It was determined after the first test flight that the boards were either to close to the power generation or the -40 C operating range on most of the sensors led to some inaccuracies in the measurement. So, an MAX31856 Thermocouple to Digital Converter IC was added to the package. The IC contained a low noise amplifier, cold junction compensation, temperature look up table, and a SPI communication interface. The Cold junction compensation had the same -40 C operating range, but it was not a debilitating factor, since the IC could be kept in the interior of the enclosure. The Type K thermocouple used had a much larger operating range and could be threaded out of the bottom of the package.

The DS3231 Real Time clock was added to insure that the Environmental Data

Logged by the sensor could be directly related to the location at which it was taken using an accurate time stamp. The DS3231 was the most accurate over the time span of the flight, in addition to having temperature compensation that could lead to inaccuracies in the real time clock. Before the real time clock was used in flight, the Raspberry Pi was connected to the Internet so that the clock could sync with Universal Time.

The power for the system was provided by 6 AA Lithium Ion Batteries. The voltage was stepped down via DC/DC converters based on the MP1584EN package for both the K-30 and Raspberry Pi. It was necessary to separate the power supply for the Raspberry Pi and the K-30 CO_2 sensor, because the K-30 sensor requires 7V and spikes of 300 mA when taking a measurement. The power demand was outside what could be provided through the Raspberry Pi. All other sensor packages were powered of the Raspberry Pi's 5V rail. The 5V supply to the Pi was further regulated by a t7805cv voltage regulator and some appropriate electrolytic capacitors.

All of the original components except the Raspberry Pi were connected via an in-house manufactured PCB, Figure 3.12. The rest were housed on an acrylic plate that was affixed to the back of the PCB, Figure 3.11. The two boards could be slid into a cardboard tube with the sensors exposed out of the face. A Foam shroud prevented cold air from leaking around the sensors into the enclosure. Either end of the tube was plugged using foam disks.

The materials used in the construction of the environmental logger is summarized in Table 3.1. The package came in at just over 200 dollars. Enclosure materials was not included in this bill of materials but can be easily manufactured for around 10 dollars.

Material	Cost
Raspberry Pi Zero	10
16 GB Micro SD Card	10
Adafruit BMP180	20
Adafruit SHT31-D	14
Adafruit MCP9808	5
Adafruit MAX31856	18
Adafruit DS3231	15
Type K Thermocouple	10
K-30 CO_2 sensor	85
Lithium Ion AA Battery	15
PCB, components, and connectors	30
Total	232

Table 3.1: Materials used in the construction of the Environmental Package.

3.3.8 Amateur Radio Repeater

The amateur radio repeater was also based around a Raspberry Pi. The Pi runs Open Repeater, a package for single board computers to enable low cost cross-band repeater functionality. The receive and transmit are handled via two Baofeng hand-holds. The handholds were electrically isolated from the Raspberry Pi using an Easy Digi interface. A usb sound card was used to interface the handholds to the Raspberry Pi, Figure 3.13.

The repeater design was low cost, light weight, robust, and was easy to assemble. The materials for the repeater came in at under 300 dollars. However, the package can be further minimized using custom built PCBs. Such a design could be used to reestablish communication of disaster areas.

VHF and UHF signals don't travel much further than line of sight, or their radio horizon. It was estimated that the extreme altitude of the balloon would give the repeater an extremely large radio horizon, Figure 3.15. Communicating through the balloon would be similar to communicating via a satellite. A low powered handheld

with a directional antenna should be to communicate through the balloon from the extents of the balloons radio horizon under ideal conditions. The balloon repeater could have been used to link communication over most of the southeastern region of the United States.

On the day of the eclipse, A repeater relay was utilized to enable HAMs in the Nashville area to make contact with the balloon using standard handheld radios. Two local repeaters were used: the AA4VU repeater and a second FT-8800 radio at the medical center. The uplink was handled by the FT-8800 radio, and downlink by the AA4VU repeater. The Balloon repeaters uplink was on the 2 meter band, 146.420 Mhz, with a tone of 123.0, and downlink on the 70 cm band, 448,800 Mhz. The FT-8800 radio was programmed to have uplink on the 70 cm band, 446.500 Mhz, with a tone of 123.0, and a downlink on the 2 meter band, 146.420 Mhz. The AA4Vu repeater was programmed to have uplink on the 2 meter band, 448.800 Mhz, with a tone of 123.0, and a downlink on the 2 meter band, 443.800 Mhz.

Material	Cost
Raspberry Pi 3	35
Radios	60
Antennas	40
Sound Card	10
Easy Digi	20
Mobile Battery	30
components and connectors	30
Total	225

Table 3.2: Materials used in the construction of the Amateur Radio Repeater.

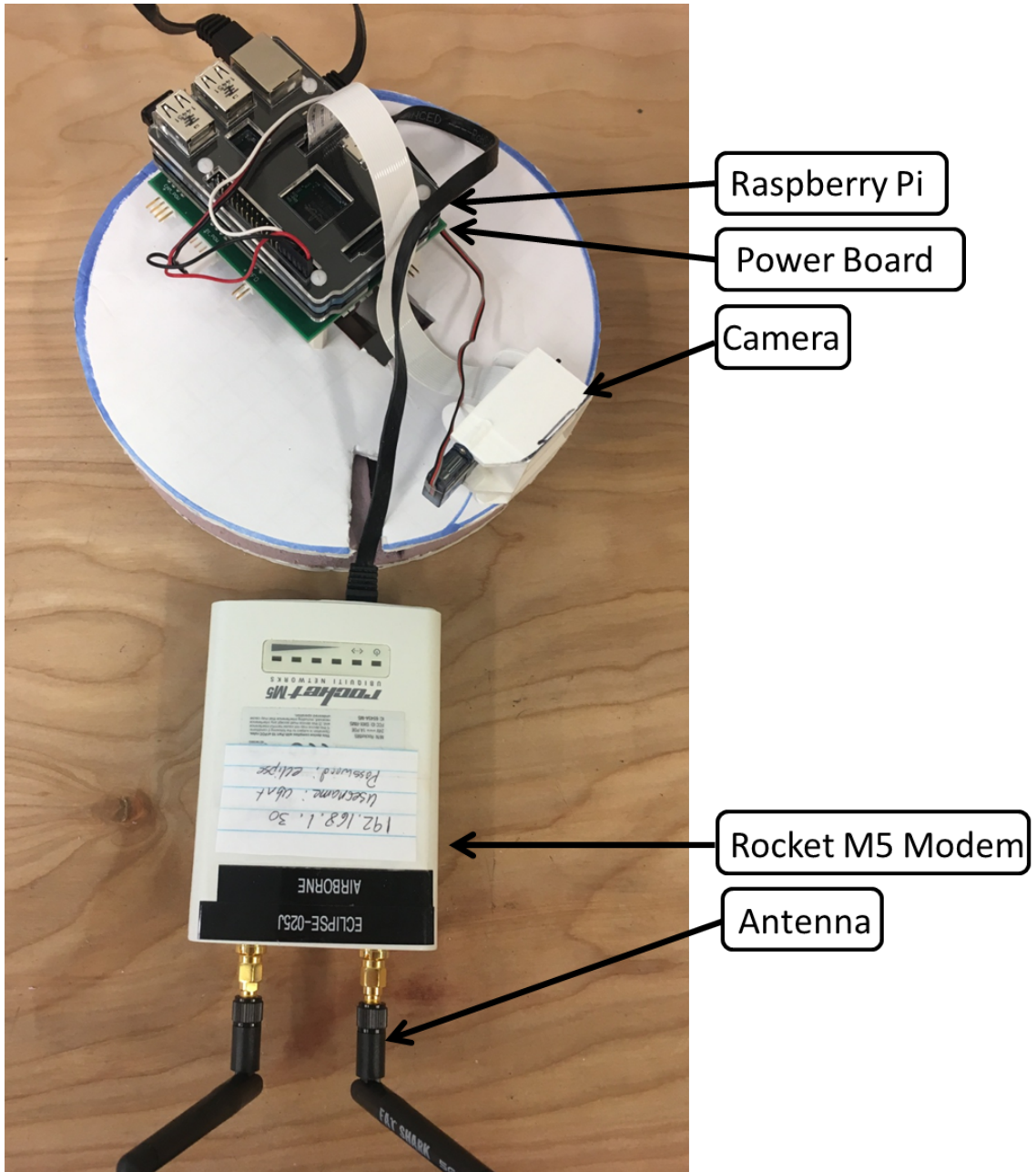

Figure 3.7: The live video package deconstructed with major components labeled.

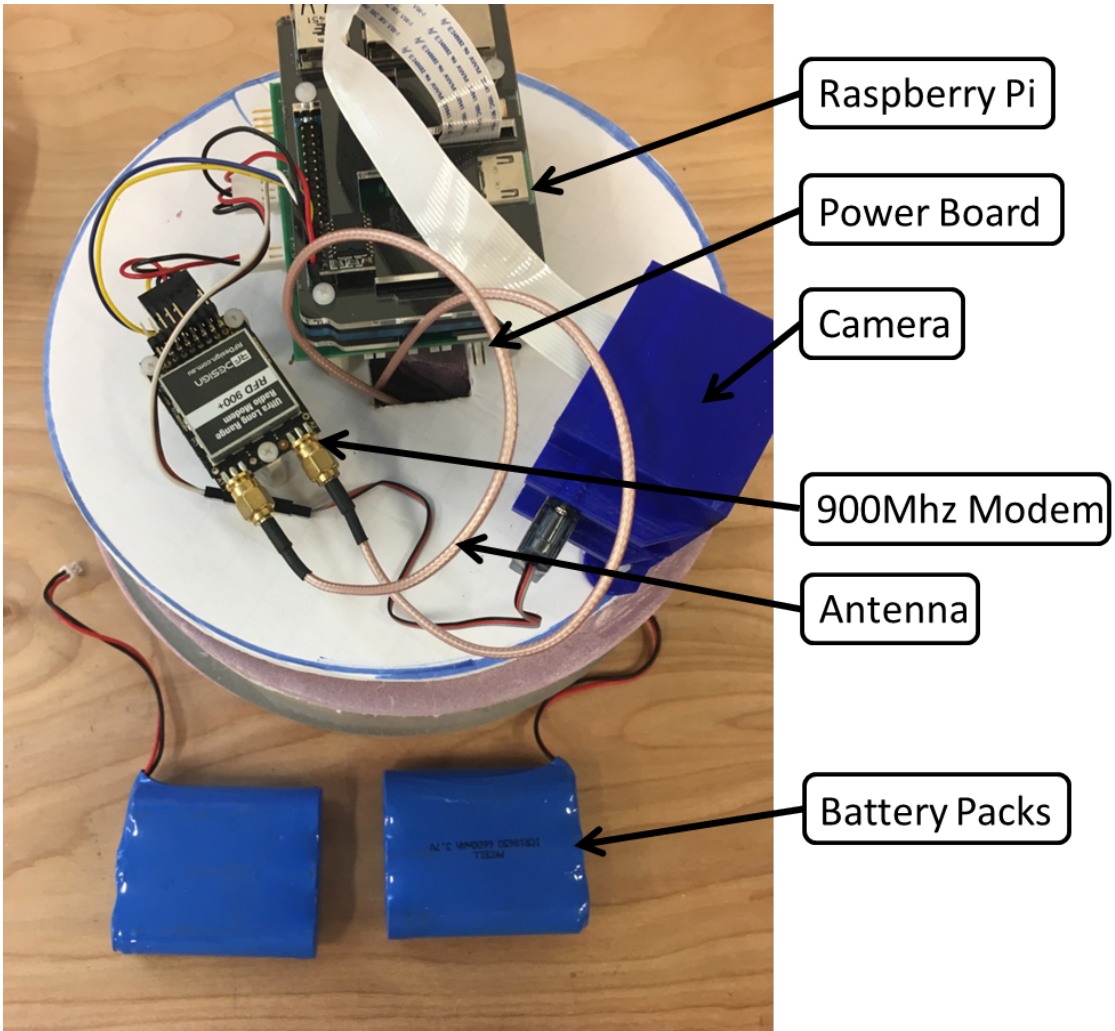

Figure 3.8: The still image package deconstructed with major components labeled.

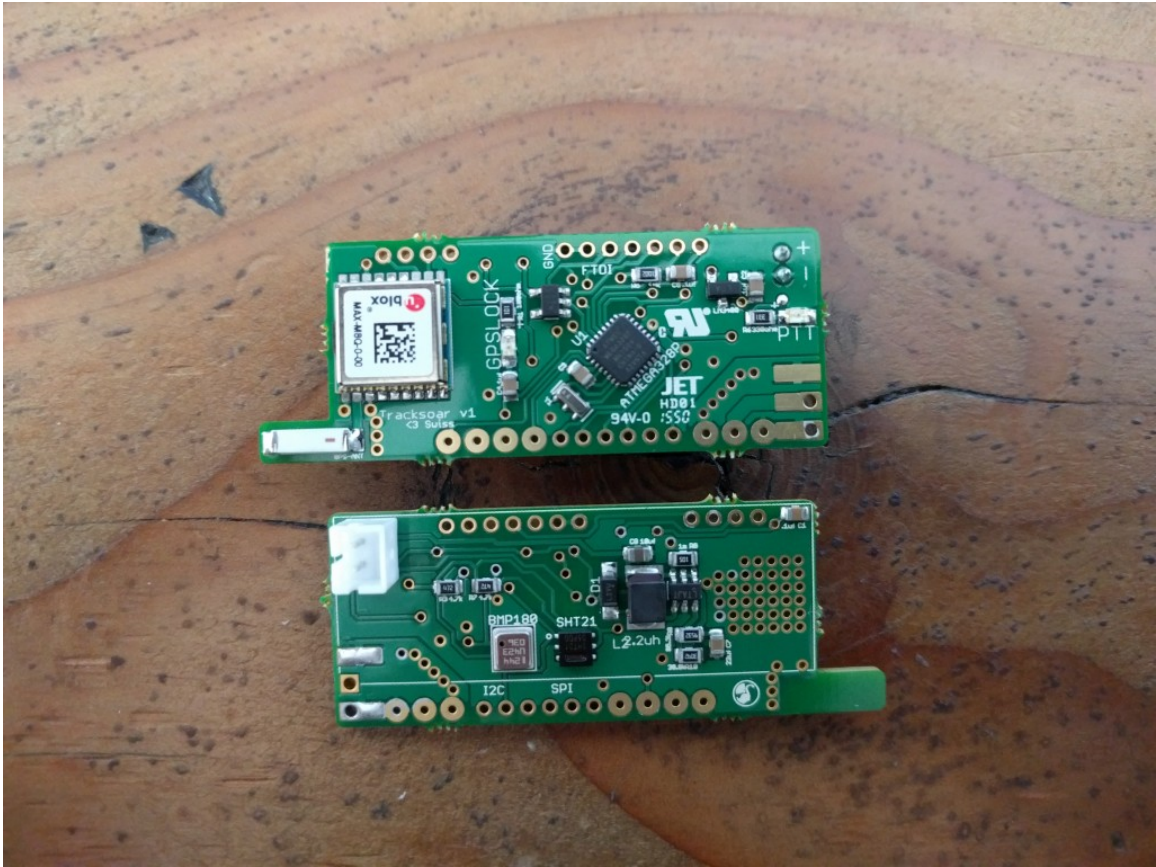

Figure 3.9: The Tracksoar unit bought to replace the APRS package lost in the first test flight [18].

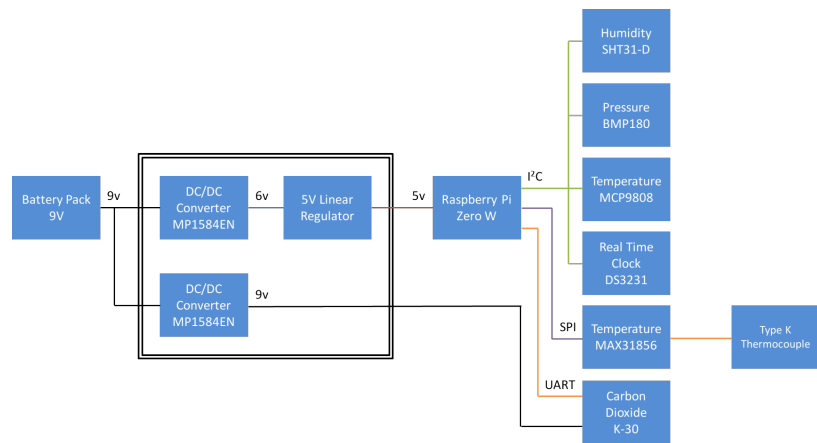

Figure 3.10: Block diagram of the components of the environmental package. The sensors are arranged by what bus on the Raspberry Pi to which they are connected.

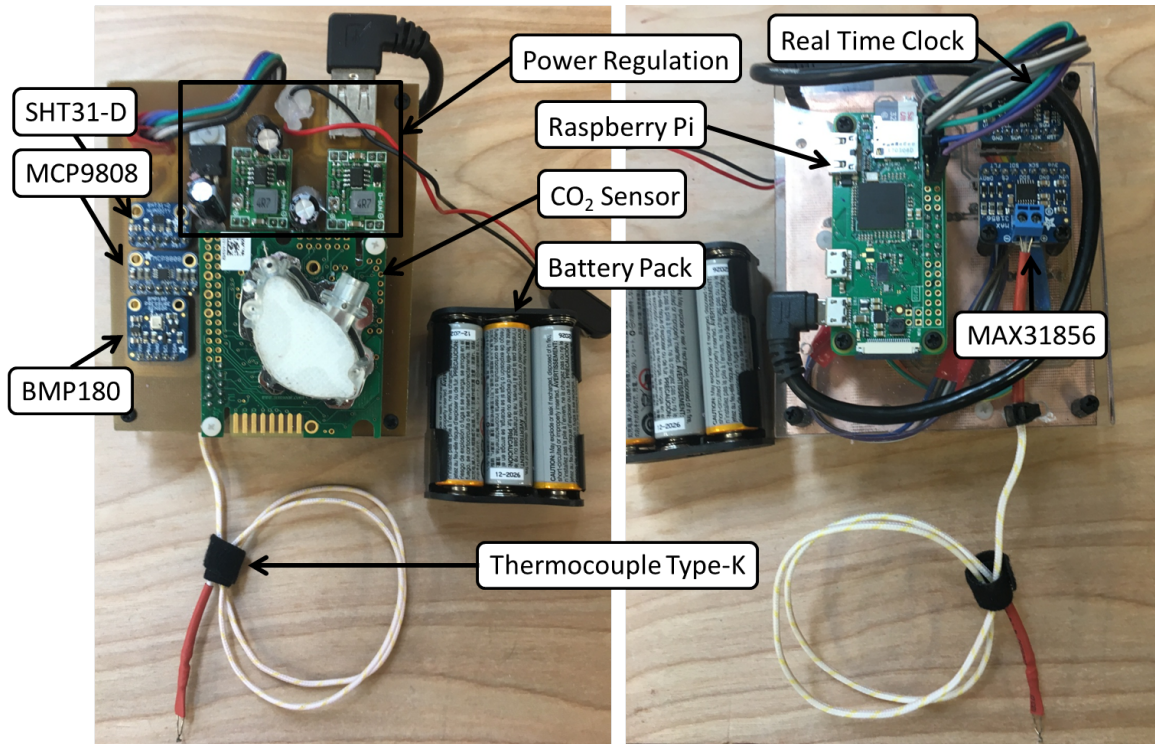

Figure 3.11: The environmental package deconstructed with major components labeled.

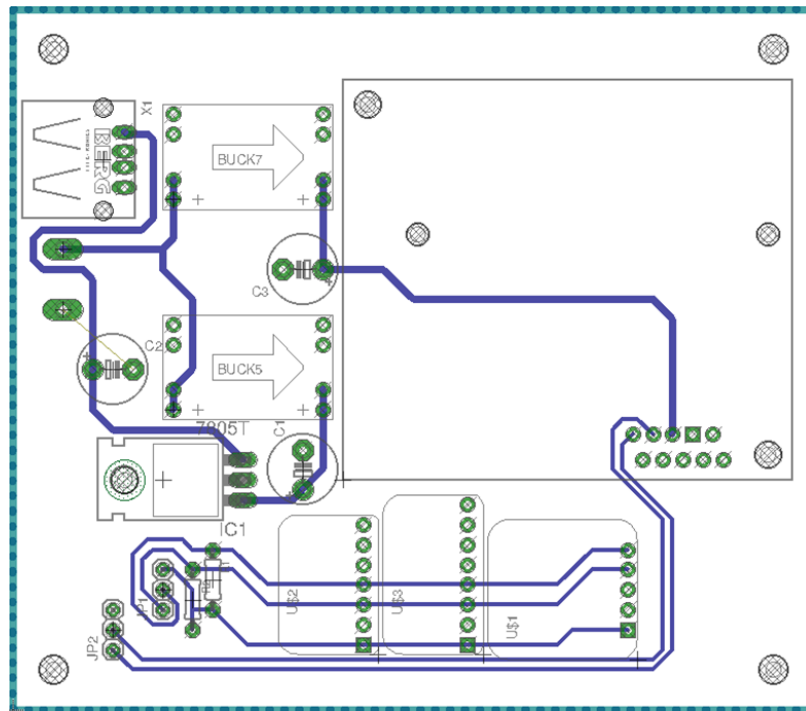

Figure 3.12: Schematic of the printed circuit board that was manufactured in house to connect the power distribution, sensors, and Raspberry Pi.

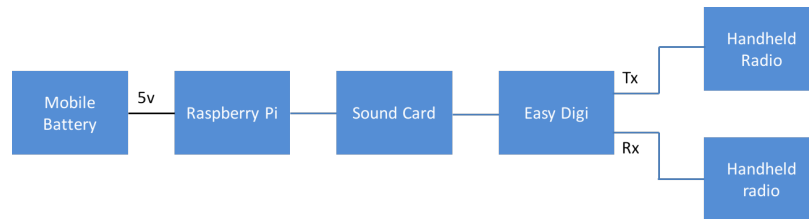

Figure 3.13: Block diagram of the components of the amateur radio repeater package.

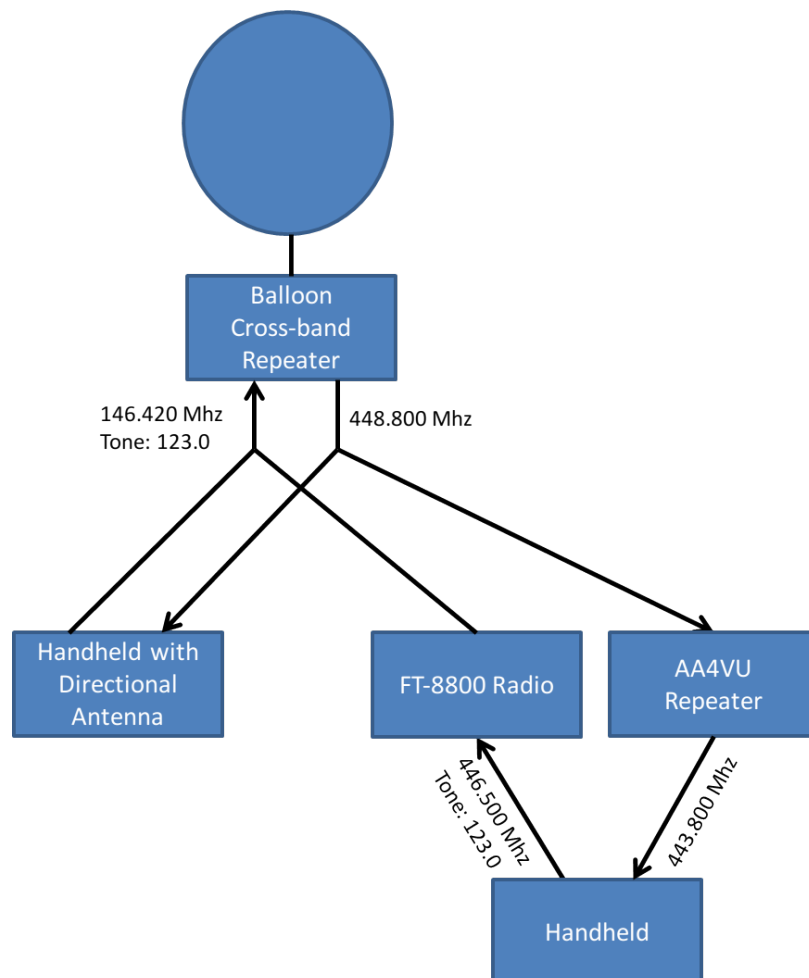

Figure 3.14: Diagram of the repeater relay used to enable easy access to the balloon repeater.

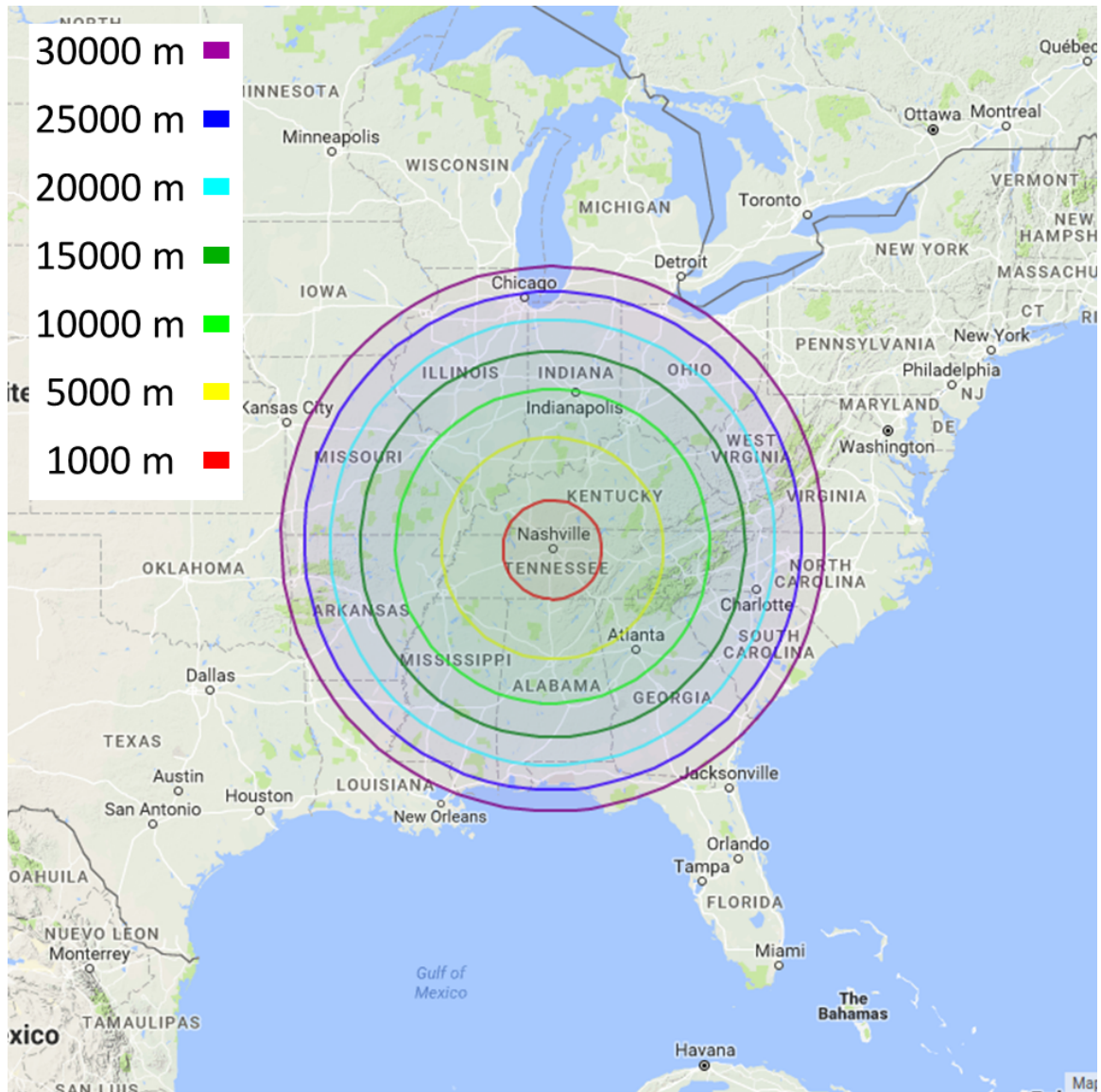

Figure 3.15: The calculated radio horizon of the amateur radio repeater for various balloon altitude.

CHAPTER 4

SOFTWARE OVERVIEW

Large amounts of the software was developed for use in this project. The majority was written in Python. additionally, some was was written in shell script and Arduino/C. Python is a easy to use but powerful scripting language that is widely used in the scientific community and provides an extensive standard library. Most of the software that was included with the standard payload was left unchanged. The streaming software used was open source, and the software used was left to the preferences of the individual teams.

4.1 Ground Station

Custom software written in Python run the ground station. The software interfaced with the 900 Mhz radio, and the pointing system. It was also responsible for pulling telemetry data from the Aries database to locate the balloon.

First, the ground station had to know its location. The coordinates and bearing could be determined using the Arduino or a manual input method.

The Arduino was programmed to collect data from the GPS and IMU breakout boards, and relay them to the control computer using the UART interface. The IMU required calibration before use. This is done by moving the IMU through multiple orientations. The calibration variables are written to EEPROM so that they can be used after a reboot.

An EEPROM clear software was included. If the Arduino was malfunctioning, the EEPROM values can be cleared and the IMU recalibrate

The telemetry data from the Iridium Modem was downloaded from a database, Aries, set up by the Montana Space Grant Consortium. However, The system could

be easily configured to receive telemetry data from other sources.

The system used the law of haversines to determine the heading from the ground station to the balloon. Then, the servo motors were commanded to move to the appropriate heading.

The system does account for the the servo limits. So, the antenna array doesn't attempt to rotate around the opposite direction but doesn't utilize the IMU for feedback control of the servos. The feedback came from potentiometers on the servos.

4.1.1 Video Streaming Computer

Two options for streaming were recommended. One utilized OBS screen capture software to stream. The other option used FFmpeg, a free software used to record, transcode, and stream. FFmpeg would run faster due to the lack of a GUI. However, It was decided to use the OBS stream capture option. The GUI would provide a quick visual check of the stream quality. Also the GUI would provide a way for spectators to watch the stream during the event.

The OBS streaming system used VLC media player to open a network stream. The VLC is directed to the IP address of the Raspberry Pi, 192.168.1.3, and the socket, 8554. Then OBS is configured capture the VLC window and steam it to the stream.live page. The VLC screen was used as a viewing platform for spectators.

Video streaming is an CPU and network intensive program. So, it was determined that separate computers would be used for tracking and streaming for a more robust operation. When attempting to stream to a public website, it is strongly recommended that the streaming computer has access to hard line Internet. Additionally, the computer is recommended to have at least an Intel i7 or equivalent processor. The computer used during eclipse day had a i7-7700 with 16 GB of RAM.

When streaming with low signal strength, the stream will be at a low frame rate and can occasionally drop out. To restore the stream, the antenna should be pointed

to obtain a higher signal strength. Then, the network stream can be reopened.

4.2 Packages

Most of the packages relied on Raspberry Pi single board computers for control and data logging. All of the custom scripting for the packages was written in Python.

4.2.1 APRS unit

The TrackSoar unit ran open source code written in Arduino/C. The original code didn't support multiple pathing modes. So, the source code was modified to provide switching between two different modes based upon altitude. If the unit dropped below 2500 feet, the unit would transmit in "low" mode. Digipeating would be enabled so the unit could be easily found. If the unit rose above 3000 feet or was reporting an altitude of zero, the unit would transmit in "high" mode. Digipeating would be disabled to prevent causing interference. The zero condition prevented the unit from ballooning from being stuck in "low" mode in the case of the gps unit failing to achieve a lock. The 500 foot difference in switching altitudes prevented noise from the gps unit from continually switching the mode in the 2000-3000 foot range in altitude.

A simple if statement was used to change a boolean based upon altitude, Listing 1. The boolean switched the constructor for the broadcast message, Listing 2.

If the TrackSoar unit was configured to not to digipeat its broadcasts, it broadcast with a WIDE2-1 identifier. If it was configured to digipeat, it broadcast with a WIDE2-2 identifier.

```
1 if (gps_altitude == 0 || gps_altitude > DIGI_ALTITUDE_SWITCH_HIGH)
2   gps_lowAltitudeMode = false;
3 else if (gps_altitude < DIGI_ALTITUDE_SWITCH_LOW)
4   gps_lowAltitudeMode = true; //end_VUARC
```

Listing 4.1: If statement to provide altitude switching

```

1 //VUARC: Two alternate headers are used for the two altitude modes
2 //Alternate s_address struct, "addressesLow", enables WIDE2-1 hop
3 const struct s_address addressesLow [] = {
4 {D_CALLSIGN, D_CALLSIGN_ID}, // Destination callsign
5 {S_CALLSIGN, S_CALLSIGN_ID}, // Source callsign (-11 = balloon, -9 =
   car)
6 #ifdef DIGI_PATH1
7 {DIGI_PATH1, DIGI_PATH1_TTL}, // Digi1 (first digi in the chain)
8 #endif
9 #ifdef DIGI_PATH2
10 {DIGI_PATH2, DIGI_PATH2_TTL}, // Digi2 (second digi in the chain)
11 #endif
12 };

```

Listing 4.2: construction of the broadcast message depends on the selected mode.

4.2.2 Environmental Package

The Pi runs through a simple Python Script to access each one of the sensors and log each one of the values into a CSV file, Listing 3. The file can then be downloaded through file transfer protocols.

Adafruit provides python libraries that manage communications with their sensors. The libraries simplify the communication, abstracting sending commands and receiving data after the interface.

The K-30 sensor doesn't come with the same packages. It makes use of the Raspberry Pi serial package to manage writing bits directly to the serial bus. The request for a reading is sent to the sensor and the response is read and parsed into a readable value using byte manipulation.

```

1 #imports from all of the three examples (not sure if i need to put in
   the appropriate directories or not
2 from Adafruit_SHT31 import *

```

```

3 import Adafruit_BMP.BMP085 as BMP085
4 import Adafruit_MCP9808.MCP9808 as MCP9808
5 import Adafruit_GPIO
6 from Adafruit_MAX31856 import MAX31856 as MAX31856
7 #imports for the k-30 sensor
8 import serial
9
10 #general imports
11 import time
12 import datetime
13
14 #creating all three instances of a sensor
15 SHTSensor = SHT31(address = 0x44)
16 BMPSensor = BMP085.BMP085()
17 MCPSensor = MCP9808.MCP9808()
18 # Raspberry Pi hardware SPI configuration for the MAX31856
19 SPI_PORT = 0
20 SPI_DEVICE = 0
21 MAXSensor = MAX31856(hardware_spi=Adafruit_GPIO.SPI.SpiDev(SPI_PORT,
    SPI_DEVICE))
22
23 #creating the serial bus for the k-30 sensor
24 ser = serial.Serial("/dev/ttyAMA0", baudrate = 9600, timeout = .5)
25 ser.flushInput()
26 time.sleep(1)
27
28 #converts temp C to temp F
29 def c_to_f(c):
30     return c * 9.0 / 5.0 + 32.0
31
32 #pulls in the status of the SHT31 sensor
33 def print_status():
34     status = sensor.read_status()

```

```

35     is_data_crc_error = SHTSensor.is_data_crc_error()
36     is_command_error = SHTSensor.is_command_error()
37     is_reset_detected = SHTSensor.is_reset_detected()
38     is_tracking_temperature_alert = SHTSensor.
is_tracking_temperature_alert()
39     is_tracking_humidity_alert = SHTSensor.is_tracking_humidity_alert()
40     is_heater_active = SHTSensor.is_heater_active()
41     is_alert_pending = SHTSensor.is_alert_pending()
42     print 'Status          = {0:04X}'.format(status)
43     print ' Data CRC Error = {}'.format(is_data_crc_error)
44     print ' Command Error  = {}'.format(is_command_error)
45     print ' Reset Detected = {}'.format(is_reset_detected)
46     print ' Tracking Temp  = {}'.format(is_tracking_temperature_alert)
47     print ' Tracking RH    = {}'.format(is_tracking_humidity_alert)
48     print ' Heater Active  = {}'.format(is_heater_active)
49     print ' Alert Pending  = {}'.format(is_alert_pending)
50
51 # You can also optionally change the BMP085 mode to one of
    BMP085_ULTRALOWPOWER,
52 # BMP085_STANDARD, BMP085_HIGHRES, or BMP085_ULTRAHIGHRES. See the
    BMP085
53 # datasheet for more details on the meanings of each mode (accuracy and
    power
54 # consumption are primarily the differences). The default mode is
    STANDARD.
55 #BMPSensor = BMP085.BMP085(mode=BMP085.BMP085_ULTRAHIGHRES)
56
57 # reading in the data from all three sensors
58
59 #initializes the MCP9808 Sensor
60 MCPSensor.begin()
61 date_stamp = datetime.datetime.now().strftime("%m %d %y %H %M %S")
62 f = open('data_' + date_stamp + '.txt', 'w')

```



```

63 f.write('time, temp SHT (Celsius), temp MCP (Celsius), temp BMP (Celsius
    ), Thermocouple temp (Celsius), Cold Junction Temp (Celsius),
    humidity (%), pressure (Pa), altitude (m), sealevel pressure (Pa),
    CO2 (ppm) \n')
64
65
66 # Loop printing measurements every second.
67 print('Press Ctrl-C to quit.')
68 while True:
69     #data from the SHT31 sensor
70     SHTtempC = SHTSensor.read_temperature()
71     SHThumidity = SHTSensor.read_humidity()
72     #data from the MCP9809 sensor
73     MCPtempC = MCPSensor.readTempC()
74     #data from the BMP180 sensor
75     BMPtempC = BMPSensor.read_temperature()
76     BMPpressure = BMPSensor.read_pressure()
77     BMPaltitude = BMPSensor.read_altitude()
78     BMPsealevel = BMPSensor.read_sealevel_pressure()
79     #data from the k-30 sensor
80     ser.flushInput()
81     ser.write("\xFE\x44\x00\x08\x02\x9F\x25")
82     time.sleep(.5)
83     resp = ser.read(7)
84     high = ord(resp[3])
85     low = ord(resp[4])
86     co2 = (high*256) + low
87     #Data from the MAX31856
88     MAXTemp = MAXSensor.read_temp_c()
89     MAXInternal = MAXSensor.read_internal_temp_c()
90     #create a time stamp for logging purposes
91     #needs to be adapted for some sort of real time clock or
92     #comp cycle counter

```

```

93 time_stamp = datetime.datetime.now().strftime("%H:%M:%S")
94 #print('Temperature = {0:0.2f} *C , {1:0.2f} *C, {2:0.2f} *C'.format(
    SHTtempC, MCPtempC, BMPtempC))
95 print(time_stamp)
96 print('Temperature SHT = {0:0.2f} *C'.format(SHTtempC))
97 print('Temperature MCP = {0:0.2f} *C'.format(MCPtempC))
98 print('Temperature BMP = {0:0.2f} *C'.format(BMPtempC))
99 print('Thermocouple Temperature MAX = {0:0.3F}*C'.format(MAXTemp))
100 print('Internal Temperature MAX = {0:0.3F}*C'.format(MAXInternal))
101 print('Humidity = {0:0.2f} %'.format(SHThumidity))
102 print('Pressure = {0:0.2f} Pa'.format(BMPpressure))
103 print('Altitude = {0:0.2f} m'.format(BMPaltitude))
104 print('Sealevel Pressure = {0:0.2f} Pa'.format(BMPsealevel))
105 print("CO2 = " + str(co2))
106 print(' ')
107 f.write(time_stamp + "," + str(SHTtempC) + ", " + str(MCPtempC) + ",
    " + str(BMPtempC) + ", " + str(MAXTemp) + "," + str(MAXInternal) + "
    ," + str(SHThumidity) + ", " + str(BMPpressure) + ", " + str(
    BMPaltitude) + ", " + str(BMPsealevel) + ", " + str(co2) + "\n")
108 time.sleep(0.5)

```

Listing 4.3: Environmental pack main python script

CHAPTER 5

LAUNCH LOGISTICS

Considerable logistical challenges had to be considered when picking a locations for the practice and eclipse flights. It was determined that all launches would be conducted in the same location so that the team could be familiarized with the location.

For this project, three locations have to be selected. The first is a location for the ground station, the second is a location for the balloon launch, and the third is the landing location of the balloon.

The ground station had to have access to hardline Internet, and reliable power. It was not advised to use any form of wireless Internet due to anticipated demand on the day of the eclipse.

The launch location for the balloon needed to be relatively open and flat. Otherwise, the balloon might pop itself on tree branches or buildings.

The landing location also had to be considered. Launching to far east would result in the balloon landing in the rugged terrain on the eastern portion of the state. Additionally, the location had to be accessible to volunteers to launch the balloon with enough space and parking.

The video streaming system had a max range of 30 miles. So during the eclipse, the video streaming package had to be no more than 30 miles distant from the ground station. The 30 mile limit was a line of sight distance not juse a projection along the ground.

To accommodate all of these requirements, it was decided that both the launch and the ground station would be placed on the 25th Avenue Parking garage. The top floor of the garage is open to the sky and high enough that the balloon shouldn't have collided into any other buildings. Also, power was readily available, and Vanderbilt's

wireless network was accessible from the garage. Later, hard line access was routed up to the top floor of the garage. The large open space on the top floor was able to host a large number of guests and reporters for all of the launches, and provided an above ground level view of the eclipse that was hard to rival. With the two test flights, It was shown that the video streaming doesn't exceed its maximum range for at least an hour and a half after launch. A stream was maintained while the balloon was 65,000 feet over Old Hickory Lake. It was thought that people would be more likely to volunteer if helping provided an excellent viewing location with room for their families.

CHAPTER 6

FIRST TEST FLIGHT

The June 20th first test flight was the Vanderbilt Eclipse Ballooning Teams first test flight. The flight revealed multiple issues and inefficiencies in the package preparation and launch process. The goal was to have the balloon in the air by 12:40 PM.

The Microhunt 2 meter beacon, Iridium tracker, live video system, still image system, environmental package, and APRS tracker were flown. The balloon reached a maximum altitude of 27,107 meters above sea level. The balloon traveled an estimated 71.8 km 74 degrees east from the launch point on 25th Avenue parking garage to land in Riddleton, TN, Figure 6.1. The balloon and most packages were lodged approximately 15 meters in a oak tree in a horse pasture.

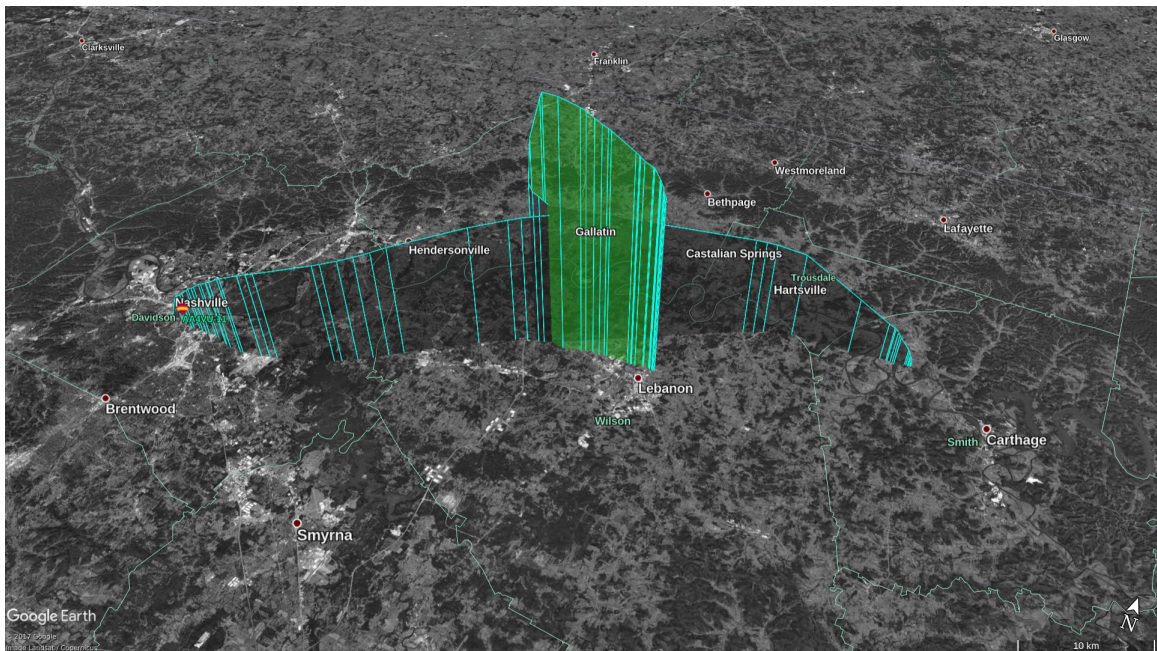

Figure 6.1: The flight path of the balloon during the second test flight on June 20th, 2017. The balloon landed in Riddleton, TN.

The APRS disconnected at altitude and was lost in the woods north of Lebanon,

Figure 6.2. An attempt to find the package by listening for broadcasts and following the maximum signal strength was made. However, no broadcasts from the APRS packet were heard. The APRS package was replaced with a Tracksoar APRS unit for future flights.

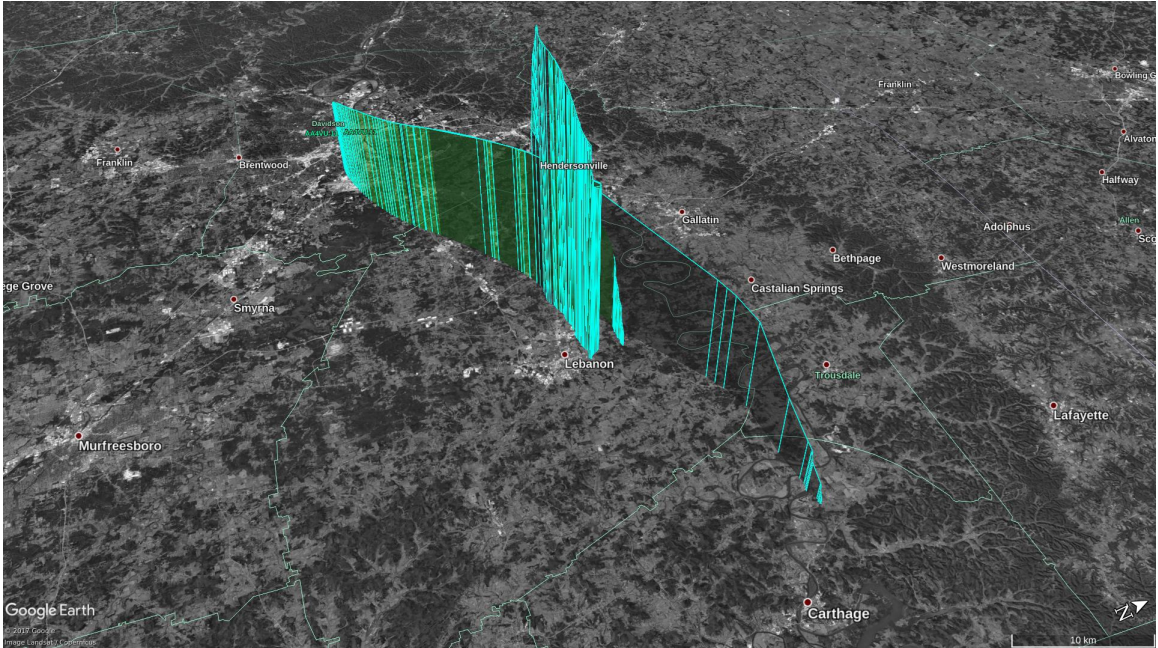

Figure 6.2: The two flight paths of the balloon and the lost APRS package.

The remaining packages that landed together in the tree were beyond recovery without specialized equipment. The tree in question was road accessible. Therefore, Vanderbilt Plant Operations lent the use of a bucket truck to recover the packages.

The video system failed completely for unknown reasons. The failure mode was not able to be replicated on the ground. So, all the batteries were charged fully and connections rechecked before future flights. It is hypothesized that the batteries ran out on the ground.

The still image system took only green pictures. The issue was intermittent, vanishing on the ground and turning green at altitude. It was theorized that the cold environment was responsible. So a series of environmental tests were made post launch to determine the cause. While being cycled from room temperature to -60 degrees

Celsius, the images taken by the package were not green.

Contacting the national organizing group about the issues revealed that the issue was a common intermittent issue. It was presumed that the cause was the python script accessing the camera before it had completed its "wake up time". So, a delay was added between creating the camera object and taking a picture.

The environmental package worked for some of the flight. The data revealed that the system functioned around 3000 to 5000 meters above sea level, and again between 7000-9000 meters above sea level. It was theorized that the enclosure didn't provide adequate support and insulation to the batteries to insure consistent operation. Therefore, after the eclipse a new enclosure was designed that completely isolated the batteries from the environment. Then, testing was performed in an environmental chamber cycling down to -60 degrees C to insure that the new enclosure functioned properly. The testing revealed that the temperature sensors were too close to the power sources to give accurate temperature measurements. A thermocouple amplifier and Type K thermocouple was added to the system. The thermocouple could be laid out away from all sources of heat inside the package, and a wider temperature range than semiconductor transducers. Therefore, it had the potential to be much more accurate than any other sensor on the package.

The Iridium tracker worked flawlessly, continually sending telemetry updates for a full day after the launch. However, the antenna pointing program proved to be unreliable updating location.

The preparation for the first test launch took hours longer than expected due to a lack of experience and too many tasks to complete. For future launches, it was determined that each package would be prepared to a much more "launch ready" state. So, the packages only needed to have batteries added and functionality checked prior to launch. In addition, each package would have an accompanying "Standard Operating Procedure" that would instruct workers through properly turning on, testing, and

hooking up of each package and the ground station. Therefore, even new volunteers had a clear set of instructions at all times. The complete set of Standard Operating procedures can be found in Appendix A.

CHAPTER 7

SECOND TEST FLIGHT

The second eclipse flight took place on August 8th, 2017. The balloon rose to a maximum altitude of 28,806 meters before falling back to earth, Figure 7.2. It traveled 57.74 kilometers 94 degrees east from the launch point on 25th Avenue parking garage, Figure 7.1. The balloon and all packages landed an estimated 24 meters high in a stand of young hickory trees.

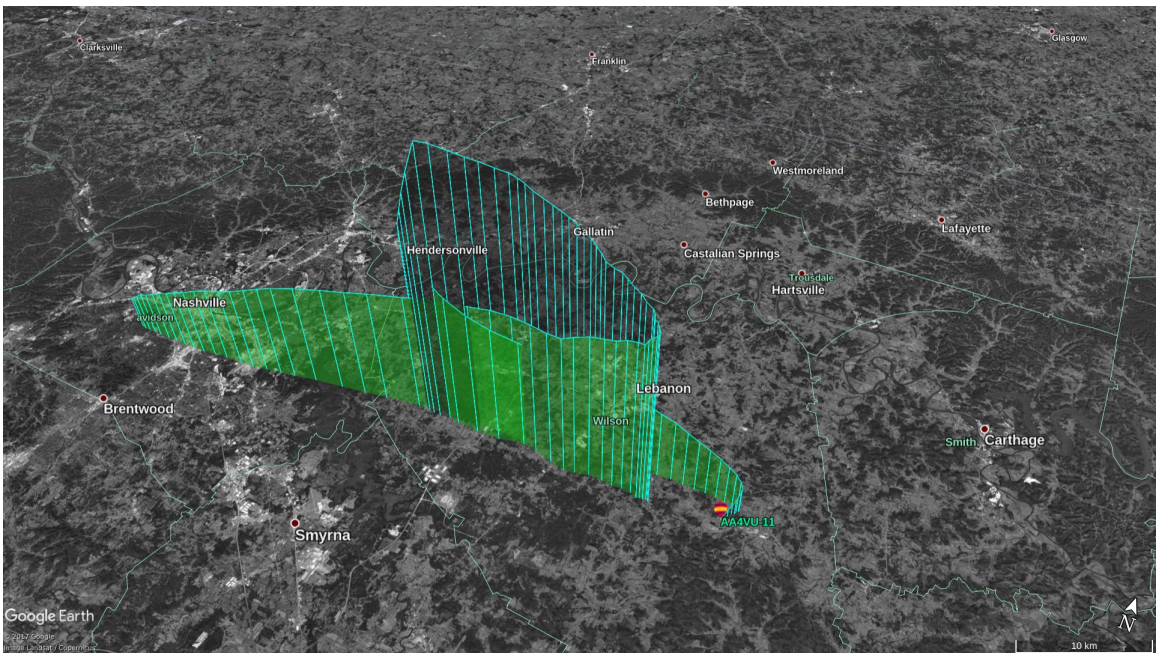

Figure 7.1: The flight path of the balloon during the second test flight on August 8th, 2017. The balloon landed in Watertown, TN.

The microhunt 2 meter beacon, Iridium tracker, live video system, still image system, environmental package, amateur radio repeater, and APRS tracker were flown.

All of the packages functioned much better than the previous test flight. Video streaming was maintained for an estimated 25-30 miles during the launch. Streaming was maintained up to 65,000 feet over Old Hickory Lake. The camera was angled too high for much of the flight, filming the atmosphere more than the horizon.



Figure 7.2: Video Still from the max altitude that the balloon reached. The Image was taken right after the balloon ruptured.

The amateur radio repeater functioned for the whole launch. The repeater accidentally had the same down link and tone as a repeater in Cincinnati, OH. At a sufficient altitude, the balloon communications were being relayed through the repeater in Cincinnati. The owner of the repeater contacted the team after hearing large amounts of unusual traffic relayed through his repeater.

Unfortunately, the stand the balloon landed in had no easy road access. So, a bucket truck was out of the question. First, an attempt was made to pull down the balloon packages by tossing a line around or through the rigging. A majority of the attempts left the lead line tangled in the branches as well. Through this method, the bottom three packages were recovered. The rest of the packages had to be recovered by hiring a professional arborist scale the trees with safety harness and cut down the entangling branches. Unfortunately the parachute and microhunt beacon crossed property lines and would have cost more to recover than replace. So, both were replaced before the eclipse.

CHAPTER 8

ECLIPSE FLIGHT

The total solar eclipse occurred on August 21st, 2017 around 1:30 PM. The goal was to launch the balloon by 12:40 to allow the balloon to experience the eclipse around 65,000 feet.

Unfortunately, the first inflated balloon broke free of its mooring during a high gust of wind. A second balloon was rapidly rigged and launch. The balloon was 40,000 feet lowed than hoped for the eclipse.

Video Streaming was maintained for the eclipse except for the 2 minutes of totality on the parking garage. The break was to allow volunteers to enjoy the eclipse because the ground station was manually pointed. Some footage of the eclipse approaching Nashville from an estimated 7500-8000 meters was recovered, Figure 8.1. Unfortunately, an unidentified bug in the code from the last software update prevented the video system from saving video at the same time that it was streaming. So full resolution video from the eclipse was not available Locally recorded video from the streaming computer caught a portion of the event from the balloons perspective.

The balloon reached a maximum altitude of 22,276 meters and flew 61.13 kilometers 101 degrees east from the 25th Avenue parking garage launch location, Figure 8.2. It landed an estimated 6 meters in a tree in Statesville, TN.

The angled downward camera managed to perfectly capture the ground, horizon, and atmosphere from high altitude, Figure 8.3.

The microhunt 2 meter beacon, Iridium tracker, live video system, still image system, environmental package, amateur radio repeater, and APRS tracker were flown.

The amateur radio repeater functioned flawlessly through the whole test flight. HAMS could check in to the repeater from as far away as Cincinnati, OH.



Figure 8.1: Image taken by the balloon at 7500-8000 meters as totality came into Nashville.

All packages were recovered with the help of the Dekalb County Amateur Radio Club, and the recovery effort was coordinated by Tom Delker.

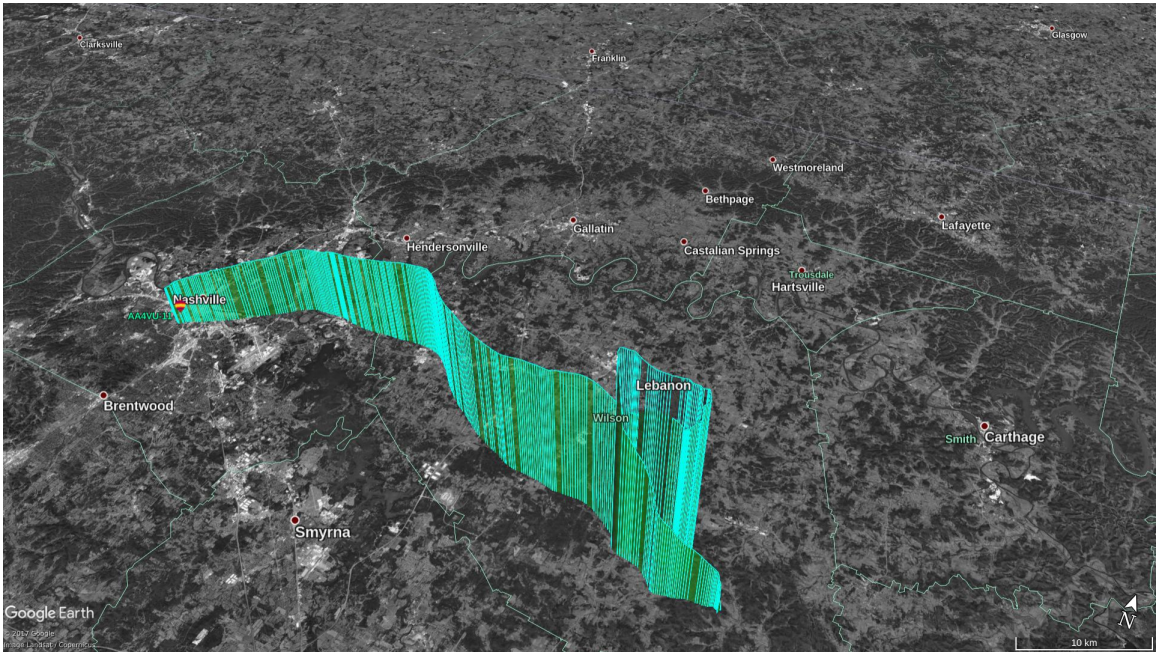

Figure 8.2: The flight path of the balloon during the second test flight on August 21st, 2017. The balloon landed in Statesville, TN.



Figure 8.3: Image taken by the balloon at 22,000 meters, near the maximum altitude of the eclipse flight.

CHAPTER 9

LESSONS LEARNED AND FUTURE IMPROVEMENTS

During the balloon flights leading up to and during the eclipse, several weaknesses of the payloads became apparent. Some of the issues could be corrected by optimizing the teams procedure. However, time and budget to make the proposed changes was not available. So, some modifications and additions to the hardware is recommended for future uses. So, a list of lessons learned and improvements are listed to incorporate into future launches.

The still image system continuously failed. First, the 900Mhz radio continuously failed to connect. In contrast the Ubiquity 5.8Ghz Rocket Modems on the live video system connected every time. Ubiquity also created a 900Mhz Rocket Modem. It is recommended that the RFD radios be replaced for a Ubiquity 900 Mhz modem to see if it would be more reliable.

The Raspberry Pi Zero W used in the Environmental Package functioned flawlessly and used significantly less power than the Raspberry Pi 3. More Raspberry Pi Zero Ws could be utilized to add more cameras in different directions (Eg. Upward facing, Downward facing, and outward facing). The wireless capabilities of the Zero could be used to create an in air network to expand the telemetry capabilities of the balloon.

When manually pointing the ground station, a signal strength indicator was used on the Ubiquity Rocket M5 modem to adjust the antenna. The antenna would be moved in small circles until the signal strength was maximized. It was proposed that if the signal strength could be reported to the base station computer, the computer could use the signal strength in a closed loop controller to maintain the best signal quality.

The servos and frame used to tilt the antennas on the ground station had a large amount of flex and backlash. Additionally, the servos had to continuously be powered to prevent the antenna away from moving or balancing the system. It might be beneficial to experiment with a lead screw and gearing to prevent back driving of the system, or balancing the antenna array. The structure would flex under the torque of the antenna.

After the first test flight, it was determined that having one or two people with knowledge of anyone system was a severe bottleneck in the preflight preparation. Standard Operating Procedures, SOPs, for each of the system were written. The SOPs led the reader through step by step instructions for each major component from installing batteries, turning them on, and hooking them to the rest of the package stack, Appendix A. So, new volunteers could be up to speed in a brief amount of time. These documents greatly sped up preflight preparations.

A SOP for the still image system was not complete written, because the radios included with the package never connected during a launch. So, feedback about the functionality of the package wasn't possible.

The Upper Tropospheric winds was the major driving factor for the balloons movement in middle Tennessee. All three flights generally drifted eastward, Figure 9.1. The eastward drift ended when the balloon rose into the Stratosphere and resumed when the balloon descended back into the Troposphere.

All of the balloon flights ended up in trees. Middle and eastern Tennessee are largely forested and often rugged terrain. When launching in the area, prepare for a tree landing. When the balloon lands in a tree, the rigging lines tangle around the branches, and the balloon can be suspended across many trees. To reliably recover all the packages, specialized tools and equipment are a must have, and sometimes professional help is needed.

The tool best suited for getting them down is the pneumatic ball launcher. The

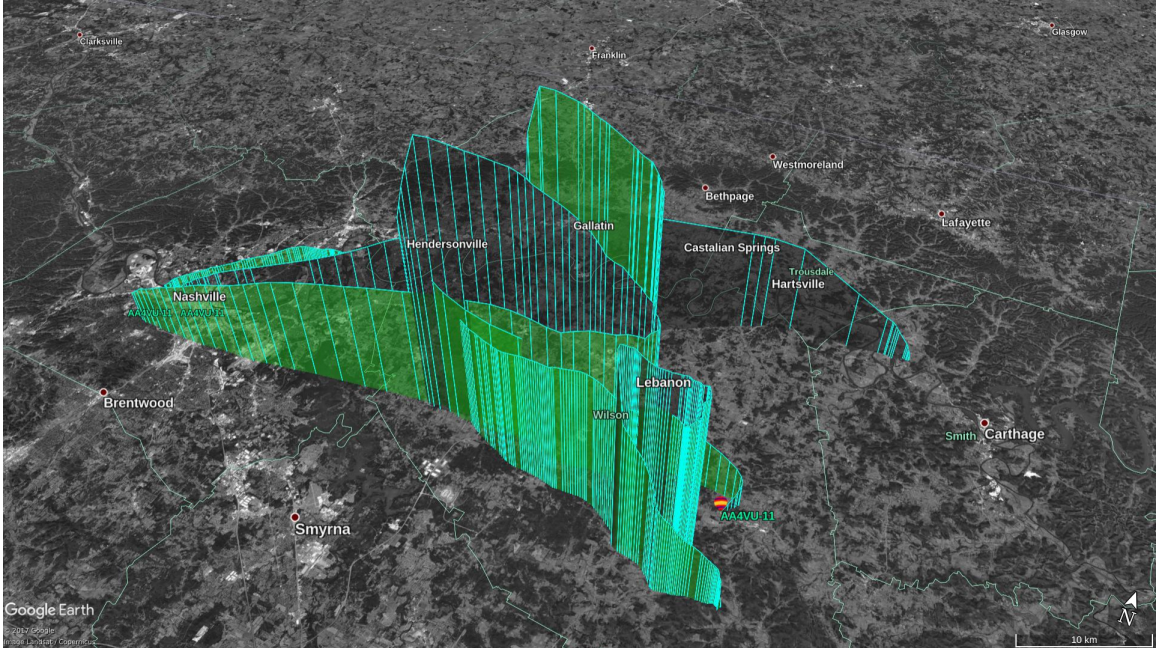

Figure 9.1: Comparison of the flight paths of the two test flights and the eclipse flight.

system can be pressurized on location by a portable air compressor. Then, a weighted ball can be fired over or through the rigging lines of the balloon trailing a light line. The light line can be used to pull up a more robust cord, and the cord used to pull some of the packages out of the tree. Due to rigging strength restrictions, it is likely the packages will fragment, and will require many successful attempts to pull all the packages out of the tree.

Large telescoping poles can be very useful if the package is relatively low in the tree. If the package is too high, the pole will be unwieldy and be much more difficult to use.

If all else fails, local arborist and tree trimmers can be helpful to recovering all of the packages. They can get into areas without road access, and trim only the required branches. However, it is an expensive option and requires local contacts.

It is possible that the balloon will land in remote regions. When going to retrieve the balloon, make sure that communication is arranged beforehand. A specific frequency or HAM repeater can keep recovery teams in contact could prevent con-

fusion and wasted time. In addition, downloaded or printed maps of the area with suspected GPS coordinates of the balloon marked are must haves. GPS on smart phones will still function without cell signal, but maps will be unable to be downloaded. A working knowledge of UTM coordinates would be helpful in finding the balloon.

A single balloon launch can represent a significant investment in time and money. Try to keep the number of risks to a minimum use as many known and temperature robust components as possible. Additionally, Keep code complexity down so that the number of bugs that develop during flight is to a minimum.

Ground testing and dry runs are very important to verify the functionality of equipment without expending consumable materials. Even though ballooning is low cost. It can be a significant investment in time. Unconsidered complications and unplanned steps can disrupt a launch. Additionally, a majority of the hardware used for balloon launch usually isn't designed for high altitude operation. A little testing and preparation can prevent a launch from being unsuccessful.

Being able to verify that all packages are functioning correctly prior to launch is preferable, and can save the flight from being a failure. The check can be easily accomplished by having wireless access to the package. The package can be programmed to automatically connect to a wireless service or broadcast a service that can be connected to from a laptop. Then, the list of process or the status of log files can be checked. Visual feedback can also be used to verify operation. Visual feedback can come in the form of status LEDs or screens.

If wireless telemetry is going to be attempted in flight, insure that the destination is receiving packets before releasing the balloon. For example, It was discovered that the live video package had a loose connection before launch on eclipse day. The stream was checked and found to be blank. The package was disassembled and reassembled to fix the issue.

CHAPTER 10

CONCLUSIONS

The Eclipse Ballooning project was truly a multi discipline project. Components of electrical, computer, and mechanical engineering were present along with physics and environmental science.

Most of the python code for the systems were multi-threaded Pythons memory management module isn't thread safe. So some of the issues of the system might have been due to different threads not relinquishing resources when it was requested. This is a possible explanation to some of the issues that the system was exhibiting during the project. However it is far from a certainty

BIBLIOGRAPHY

- [1] Lowe, R. High Altitude Ballooning code for the Raspberry Pi and Sense HAT. <https://github.com/pngwen/habpi>
- [2] National Weather Service Radiosonde Observations. https://www.weather.gov/gjt/education_corner_balloon
- [3] Masi, S., De Bernardis, P., De Troia, G., and et. al. (2002). The BOOMERanG experiment and the curvature of the Universe. *Progress in Particle and Nuclear Physics*. 48. 243-261.
- [4] Project Lune. <https://x.company/loon/>
- [5] Gregory, D.D. , Stepp, W.E., NASA's long duration balloon program: the last ten years and the next ten years, In *Advances in Space Research*, Volume 33, Issue 10, 2004, Pages 1608-1612.
- [6] Smith, D. and Marianne, B.S. (2017). Ballooning for Biologists: Mission Essentials for Flying Life Science Experiments to Near Space on NASA Large Scientific Balloons. *Gravitational and Space Research*. 5. 52-73.
- [7] NASA's Scientific Visualization Studio. <https://svs.gsfc.nasa.gov/>
- [8] Eclipse Ballooning Project. <http://eclipse.montana.edu/>
- [9] Deal, D. NGSS Lesson Planning Template(Eclipses).
- [10] Lawrence, L. and Hartmann, R. Total Solar Eclipse Unit.
- [11] Amento, R. and Waack, L. Eclipse Unit.
- [12] 2017 Solar Eclipse Streams. <https://eclipse.stream.live/>
- [13] Part 101 - Moored Balloons, Kites, Amateur Rockets, Unmanned Free Balloons, and Certain Model Aircraft. <https://www.ecfr.gov/cgi-bin/text-idx?rgn=div5&node=14:2.0.1.3.15>
- [14] APRS.fi <https://aprs.fi/>
- [15] Bruninga B. Automatic Packet Reporting System. <http://www.aprs.org>
- [16] Smith S. H. (2016, June 16). APRS Digipeating and Path Selection 101. <http://www.wa8lmf.net/DigiPaths/>
- [17] MicroHunt Foxhunting Transmitter. <http://www.west.net/marvin/microhnt.htm>
- [18] Tracksoar. <https://www.tracksoar.com/>

Appendix A

STANDARD OPERATING PROCEDURES FOR LAUNCH

To insure that all volunteers knew what to do on launch days, a series of standard operating procedures were written. Each volunteer or team of volunteers could be handed one system and corresponding SOP to prepare for the launch.

Under ideal circumstances all of the SOPs would be completed simultaneously. Then, battery charge used while the packages were on the ground would be minimal. Practically, it is difficult to work through them all. So, it is best to work on not mission critical packages or those with an excessively long battery life first. Then, work towards those with the shortest battery life.

At each launch, the rigging diagram was posted, Figure A.1. The diagram specified the order each one of the packages would be suspended under the balloon. This avoided confusion and increased the amount of work an inexperienced volunteer could do without oversight.

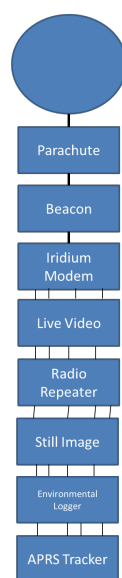

Figure A.1: Order that the packages were hooked up to the balloon. The Diagram was posted at all launches, so volunteers knew how to hook up their designated package.

A.1 Ground Station and Iridium Tracker

1. make sure that the location for the ground station has access to power. The ground station might have to be on a separate circuit from the ground station computers to prevent overloading the circuit.
2. Make sure that the ground station is connected according to the diagram, Figure 3.2.
3. Start up the Antenna Tracker program on the tracking computer.
4. Make sure all the ports for the devices are filled (COM ports).
5. Check that the IMEI field is filled in correctly, same IMEI number as the Iridium modem (300234064909600).
6. Under tracking devices make sure that the Iridium box is checked.
7. Click "Update Settings". When the new window pops up, calibrate the IMU unit by alternating the orientation of the IMU until the window reports 3 degrees of freedom calibrated for all sensors. there is an alternate method to this step.

Alternative Calibration Method

1. Turn on the Servos and make sure they are both in their zero position(Antenna pointing forward and level).
2. Pick up the antenna assembly, tripod and all. Rotate the assembly to the cardinal direction the balloon is most likely to travel (most likely east for Tennessee).
3. change the option in the top middle box from "Get local (Arduino)" to the option corresponding to your cardinal direction.
4. Add in the GPS coordinates of the ground stations location. (these can be pulled from google maps).

5. Hit update settings.

Iridium Tracker

1. Install the battery on the Iridium tracker.
2. Insure that the tracker is powered on. Set it out in the open and make sure that the Iridium and GPS lights on solid.
3. Go to eclipse.rci.montana.edu and insure that the tracker is listed and active, the current location shown on the map and under the IMEI number 300234064909600.
4. Look to see if the antenna swings around to point at the package.
5. Seal up the package with zip ties and use the key rings to connect it to the other packages according to the rigging diagram.

A.2 Still Image Package

1. Check the antenna connections to the RFD modem on the ground station and package. Insure that the cables are routed cleanly and free of strain.
2. Plug battery into the "M5" and "Pi" plugs on the custom power board and route the cables neatly.
3. Use the barrel key to turn on the package
4. Place the package in direct line to ground station antennas. Look for the lights on the RFD 900 modem to go solid green.
5. Wait for at least two minutes. Then, use the ground station GUI to request the most recent picture from the package.

6. Use Zip Ties to make sure any loose components are held solidly, and fasten on the top of the package.
7. Use the key rings in the rigging to attach the package according to the rigging diagram.

A.3 Video Payload

1. Make sure that the Ethernet cable from the M5 rocket modem is inserted into the computer dedicated to streaming.
2. If using the Linux desktop, make sure the computer is connected to "Ground Station". This makes sure that the IP address is static for communication with the modem.
3. Plug batteries into the "M5" and "Pi" slots on the custom power board and nest them into their layer in the package.
4. Turn the barrel key in the switch to turn on the Video Payload. and place it in direct line of sight of the ground station.
5. Look at the signal indicator on the ground station M5 modem to make sure there is a strong connection between the two (the indicator bar should go all the way to the green, and the connection LED should be flashing).
6. Start up a SSH client (Bitvise on windows, Remmina or terminal on Linux) and connect to the Raspberry Pi. (IP: 192.168.1.1 Username: pi Password: raspberry).
7. In the terminal use the command "ps aux | grep python" to print the list of running processes.
8. Check to make sure there is a python process running.

Starting the Stream

1. Start up VLC Media Player.
 2. Open up a network stream under the "Media" Tab and enter the address "rtsp://192.168.1.3:8554/".
 3. Make sure that live video is displayed on the network stream.
 4. Start OBS. Under settings, software should be configured to stream to the URL, "rtmp://media.stream.live/live", and the Stream Key field should be full.
 5. Under the sources, "windows capture (Xcomposite)" should be highlighted.
 6. Click the start streaming button and start recording on the lower right region of the screen.
 7. Verify that the stream is live at the streaming location.
-
1. Make sure that there is no loose connections or components are free to move inside the package.
 2. Use Zip ties to secure the top of the package.
 3. Use the key rings to fasten the packages together according to the rigging diagram.

A.4 Environmental Package

1. Put new batteries into the Battery Pack, and connect the pack to the power board.
2. Insure that the lights are blinking on both the CO_2 sensor and the Raspberry Pi.

3. Pack the batteries and board into the canister and make sure the sensors are aligned with the holes in the canister and the foam shroud is in place.
4. Use a Wi-Fi enabled computer to connect up to the network: "EvoPack" Password: "password".
5. Use the computer to SSH into the Pi using software of choice (see directions for the Video Payload). The IP: 192.168.1.1, username: "pi", and password: "raspberrry".
6. Use the command "ps aux | grep python" to check that python scripts are running.
7. Use zip ties to fasten down the top.
8. Connect the package to the stack according to the rigging diagram.

Appendix B

ENVIRONMENTAL DATA

The environmental logging package took thousands of data points, one point from each sensor approximately every second during the flight, for two flights. The first test flight, it malfunctioned presumably due to low temperatures dropping the voltage of the batteries. However, for the August 8th and August 21st flight it functioned through the whole flight.

Each set of data was timestamped using the DS3231 real time clock. The time stamp was used to relate it to the location the data was taken. This was done by using a python script to create linear interpolation functions for a combination of the Iridium and APRS GPS reported time, altitude, latitude, and longitude. Then the time stamp on the data set was used to estimate the position with the interpolated functions.

B.1 Heading

Each layer of the atmosphere can have a different wind speed and direction, and the balloon moves with the wind during flight. So wind speeds and directions can be inferred from the balloons flight path. As the balloon transverses multiple layers of air, distinct changes in the movement of the balloon can be seen.

The main regions the balloon transverses are surface winds, the troposphere, tropopause, and stratosphere. By looking at the altitude vs. longitude, the altitude when the balloon leaves different streams of air is apparent. The balloons moved from west to east with the movement being an order of magnitude larger than north to south, Figure B.1 B.2.

There is three distinct changes in the direction of the balloons travel during the

August 8th Launch, Figure B.1. The balloon left surface winds and reentered them around 4000 meters. The tropospheric winds blew the balloon eastward between about 4000 and 18,000 meters. the stratospheric winds took effect over 18,000 meters.

The eclipse flight was to a lower altitude so the features of the stratosphere are not as well defined, Figure B.2. The surface winds for the the August 21st flight are less distinct and appear to be mostly stagnant on landing with a little bit of movement in the latitudinal direction.

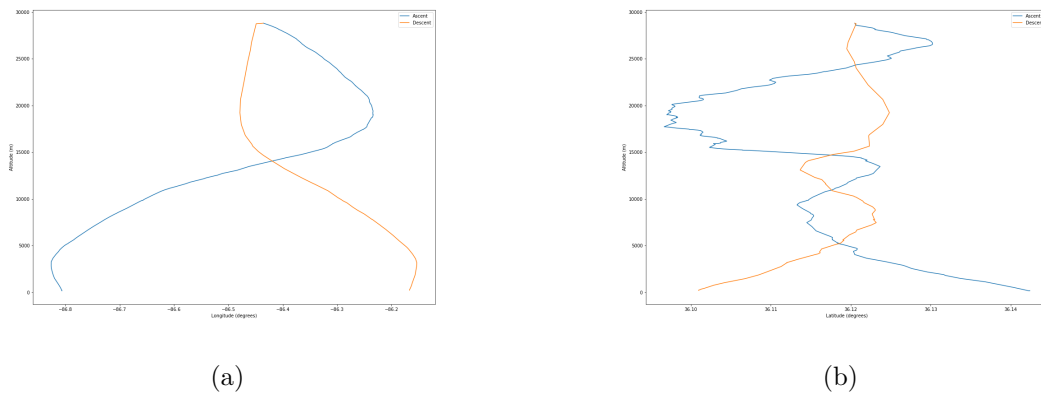

Figure B.1: The (a) longitude and (b) latitude plotted against altitude for the 08/08 flight. The different currents of air can be clearly seen by when the balloon changes direction. A large majority of the balloons movement is in longitudinal directions.

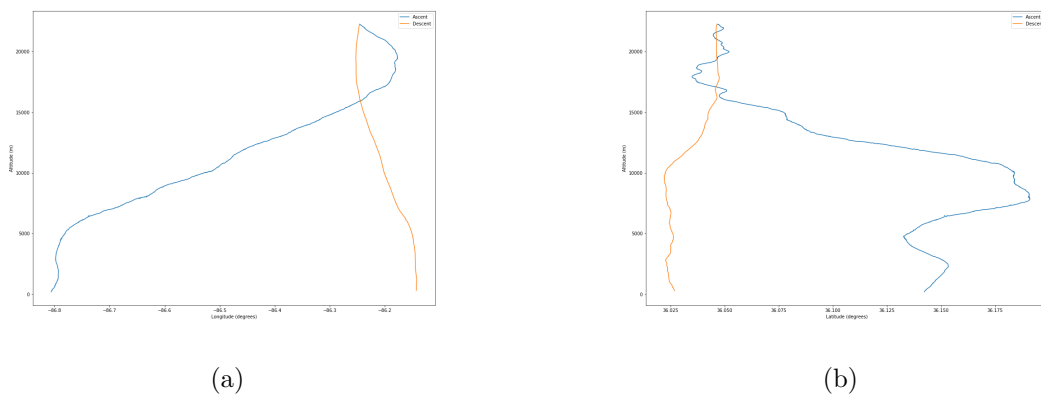

Figure B.2: The (a) longitude and (b) latitude plotted against altitude for the 08/21 flight. The different currents of air can be clearly seen by when the balloon changes direction. A large majority of the balloons movement is in longitudinal directions.

The coordinates can be used to derive the bearing and speed of the balloon using the law of haversine. The derived curves were noisy due to the low sampling speed of the GPSs along with GPS bounce. However, the bearing and speed from the August 8th flight shows high stratospheric winds at 10-16 km altitude, and distinct wind bearings between different layers of the atmosphere, Figure B.3.

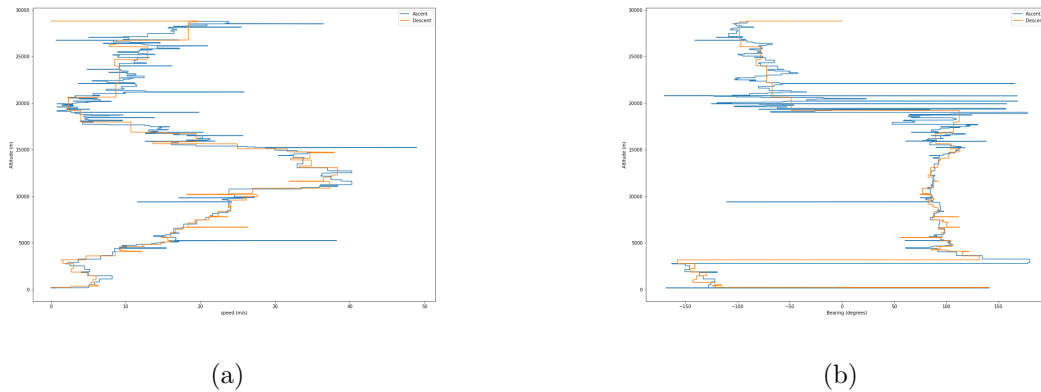
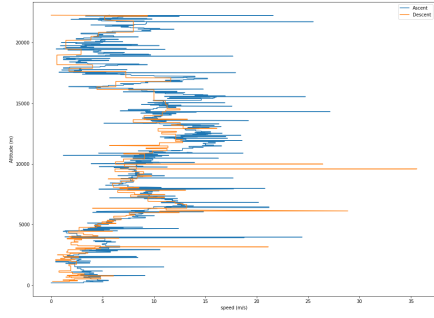

Figure B.3: The derived wind (a) speed and (b) bearing plotted against altitude for the 08/08 flight. The different currents of air can be clearly seen by when the balloon rises above a defined altitude.

The atmospheric features during the eclipse flight is much harder to decipher, Figure B.4. The stratospheric winds are much slower but at approximately the same altitude.

The ascent and descent rates was calculated from the interpolated altitude, Figure B.5. Generally, the ascent rate during the 8th was higher then the eclipse flight. The slow ascent rate was likely due to a slightly under inflated balloon launched during the eclipse, due to launch complications. The ascent rate was noisy. Some of the noise was likely due to the offset between the APRS and Iridium GPS unit. It is possible that the higher of the two modules reported seconds before the lower. When the data was combine, it could result in a very large apparent descent rate. The reverse of this effect can be seen during the descent as well. During the descent, the balloon gradually slowed down as the parachute got into thicker air. The curves follow each



(a)

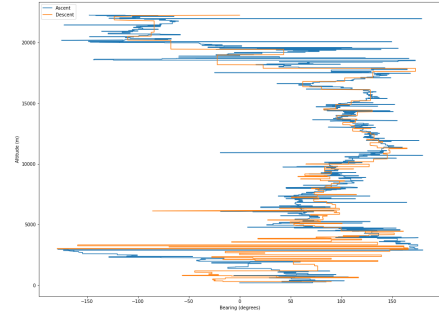

(b)

Figure B.4: The derived wind (a) speed and (b) bearing plotted against altitude for the 08/21 flight. The different currents of air can be clearly seen by when the balloon rises above a defined altitude.

other closely during decent even though the balloon on the 8th got to a much higher altitude. This implies that the balloons reach terminal velocity quickly.

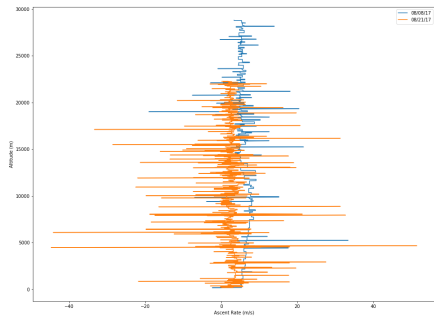

(a)

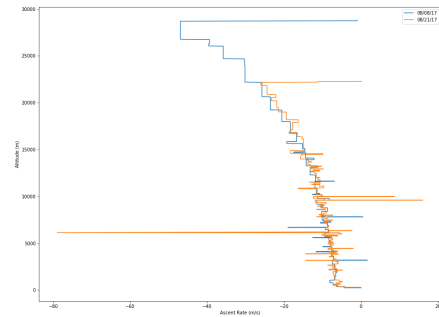

(b)

Figure B.5: The (a) ascent and (b) descent rate of the balloon derived from the altitude data of the balloon.

The balloon generally follows the exact same bearing pattern on the ascent that it does on the descent. It drops much faster than it rises. so, the path is mirrored but shrunk.

B.2 Temperature

The temperature was measured by multiple sensors in different locations on the environmental package, Figure B.6 B.7. The Temperature of the environment was most accurately measured by the type k thermocouple, B.8. The transition between the troposphere and stratosphere can be clearly seen by the transition in temperature tends at around 16,000 meters. The other sensors were either on the interior of the enclosure, or close to the power distribution components.

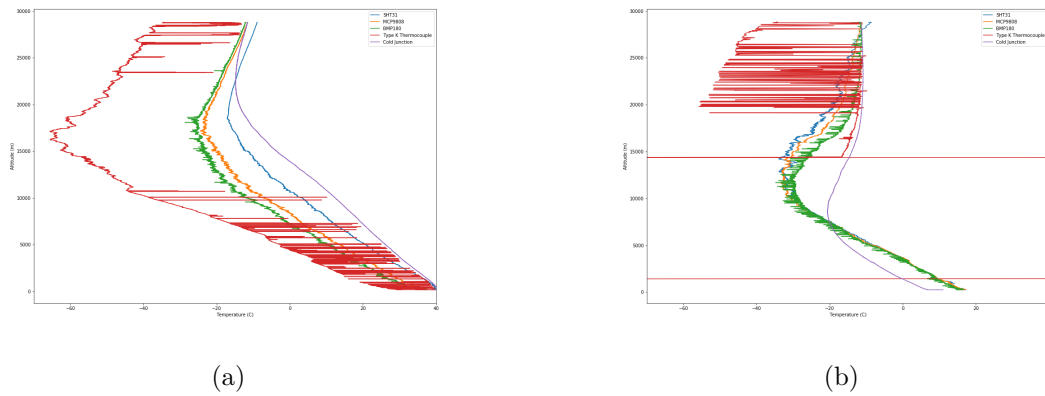

Figure B.6: Temperature reported by all the sensors on board the environmental logger during the the 08/08 test flight during (a) ascent and (b) descent.

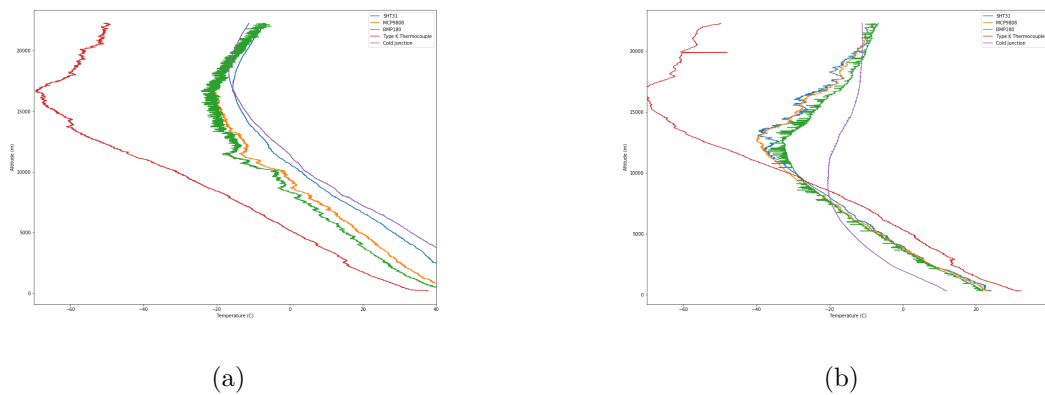

Figure B.7: Temperature reported by all the sensors on board the environmental logger during the the 08/21 test flight during (a) ascent and (b) descent.

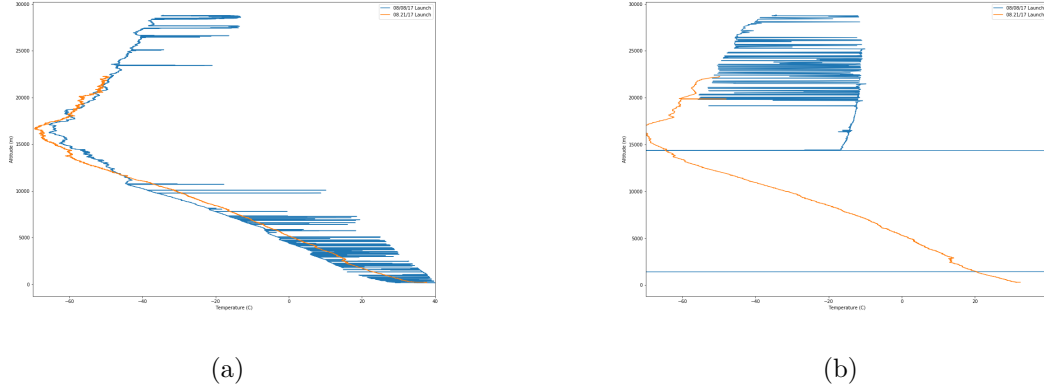

Figure B.8: Comparison of the temperature measured from the Type K thermocouple for both the 08/08 and 08/21 flights for (a) ascent and (b) descent. It can be easily seen that the thermocouple on the 08/08 flight was lose in the socket and fell out around 15000 meters.

The balloon had a large number of IC temperature sensors on board. All of the temperature data collected is shown in Figure B.6. The effects of the bad connection at the thermocouple can be seen. However, The cold junction inside the contain stayed well within an acceptable temperature range for the whole flight. The temperature sensors on the BMP180, SHT31, and MCP9808 stayed significantly warmer than the environment, the proximity to the power distribution and Raspberry Pi might have heated them above the temperature of the environment.

It was substantially colder at the tropopause during the eclipse flight than during the August 08th flight. This could be due to some of the atmospheric cooling from the eclipse. However, it is unknown without further verification.

The thermocouple data from the 8th had a large amount of noise due to a lose connection. The lowest temperature experienced during the flight was around -66 C, and the tropopause was between 15,000 and 18,000 meters, Figure B.9. Eventually the thermocouple fell out of the terminal at around 15,000 meters during the descent, Figure B.6.

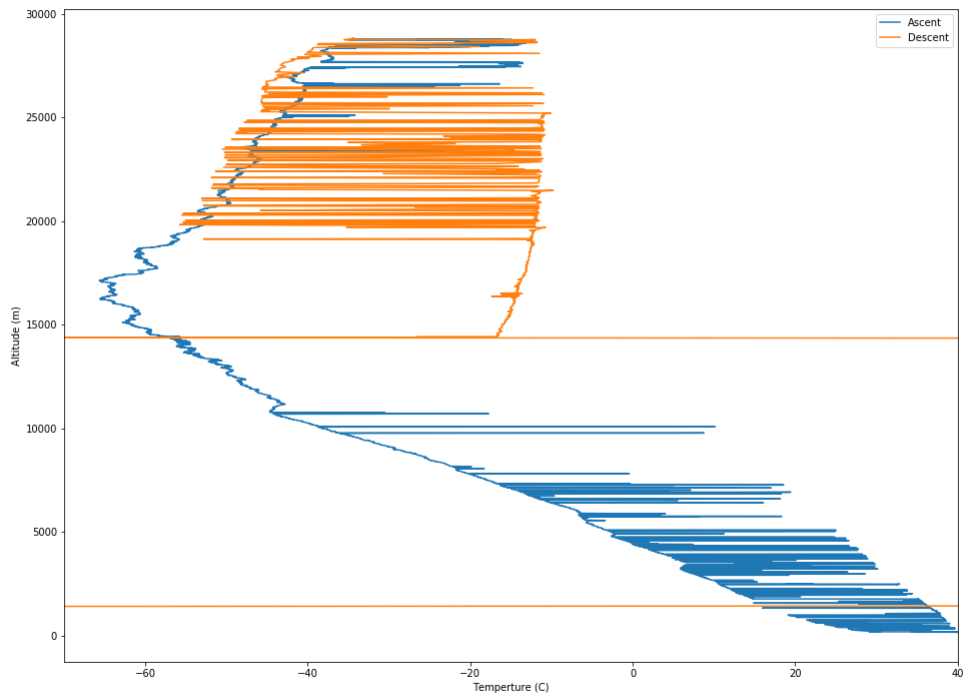

Figure B.9: Temperature measured by the Type K thermocouple during the 08/08 flight for ascent and descent.

B.3 Humidity

The humidity sensor between the two launches shows remarkably similar trends, Figure B.11. However, the humidity goes to zero within the coldest region the balloon transversed. It is doubtful that this is accurate. It is more likely an effect of the cold temperatures. During descent both flights reported a significant gain in humidity. This is probably an artifact of the cooling rate. As the balloon falls quickly, the sensor reaches warmer air, and condensation could form. The most accurate data from the humidity sensor is most likely before 10,000 meters on the ascent of the balloon.

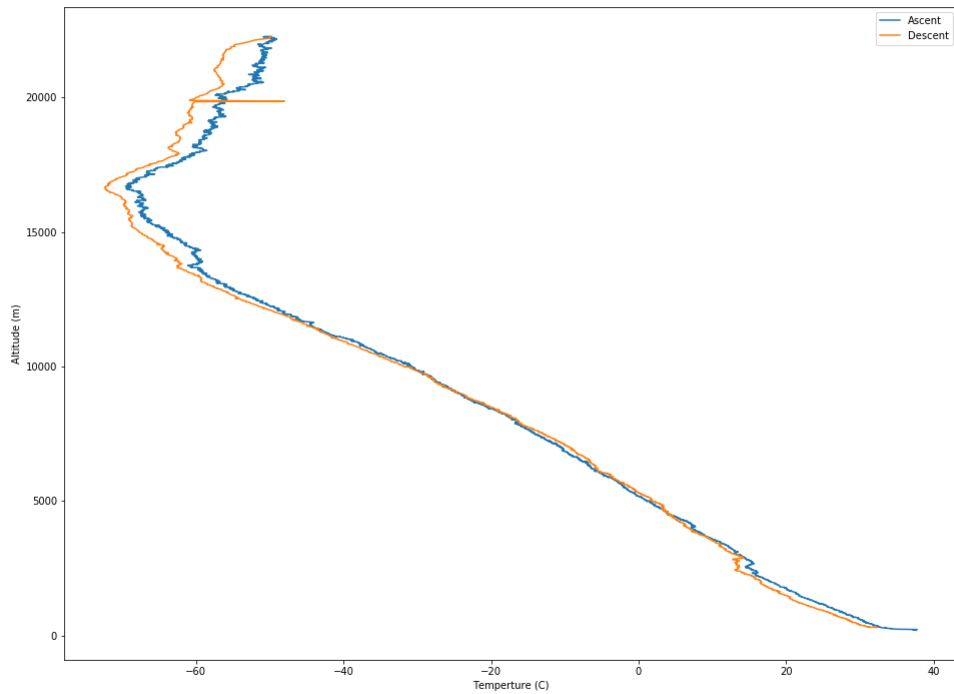

Figure B.10: Temperature measured by the Type K thermocouple during the 08/21 flight for ascent and descent.

B.4 Pressure

The pressure fits what would be expected. With increasing altitude, the pressure decreased, Figure B.14. It is almost linear within the range of the troposphere. Pressure based altimeters can be accurate within this region. However, in the tropopause the pressure decreases more exponentially. The pressure was almost exactly the same between the two test flights.

B.5 CO_2

The CO_2 measured similar levels of atmospheric CO_2 on both flights, Figure B.17. However different amounts of CO_2 were measured during ascent and descent, Figure

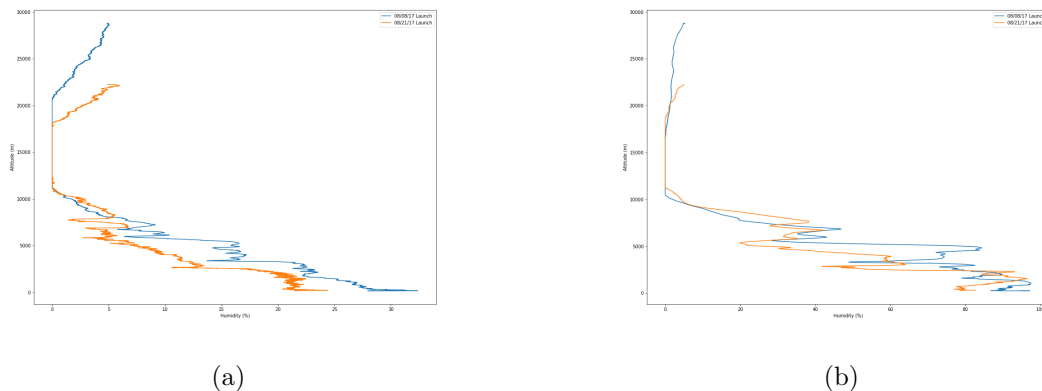

Figure B.11: Comparison of the humidity measured from the SHT31 IC for both the 08/08 and 08/21 flights for (a) ascent and (b) descent. The accuracy of the data above 1000 meeter and during decent is doubtful due to the sensor being below temperature limits.

B.18 B.19. The sensor saturated multiple times during the the August 8th flight, Figure B.18. The reason for the saturation is unknown.

The K-30 sensor depends on a diffusion chamber to make measurements. So, the sensor exhibits some amount of pressure dependence that should be corrected out. Additionally, The sensor has a measurement inertia while the diffusion process takes place. At rapidly changing pressures and environments, the sensor shouldn't be determined to be accurate. So, the descent should be ignored. Most air quality sensors are sensitive to more than one type of gas. Therefore, The changing atmospheric composition might also add error to the measurements.

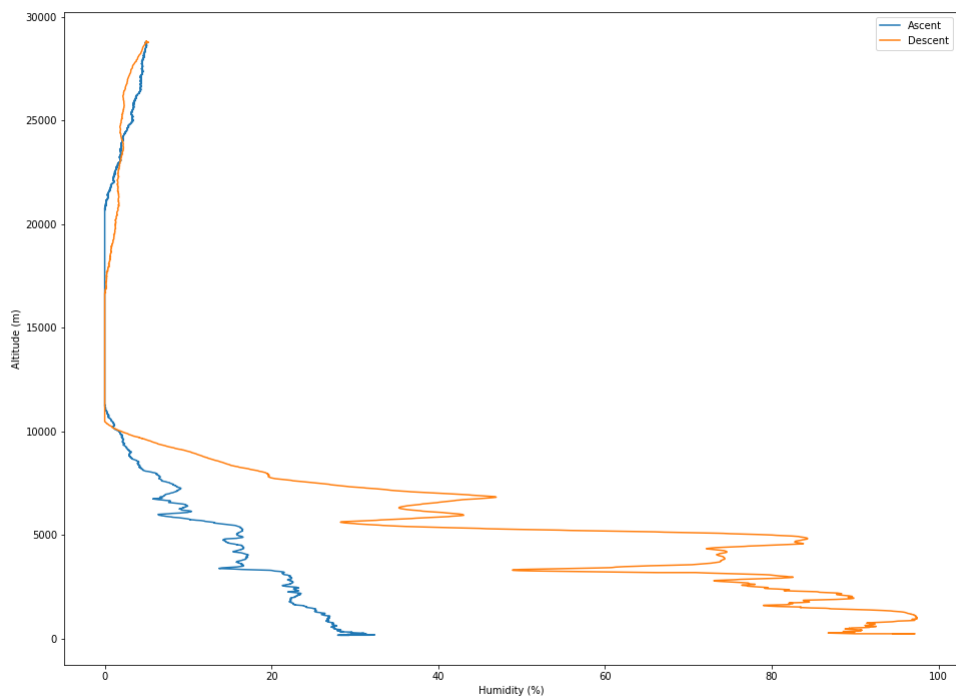

Figure B.12: Humidity measured during the 08/08 flight for ascent and descent.

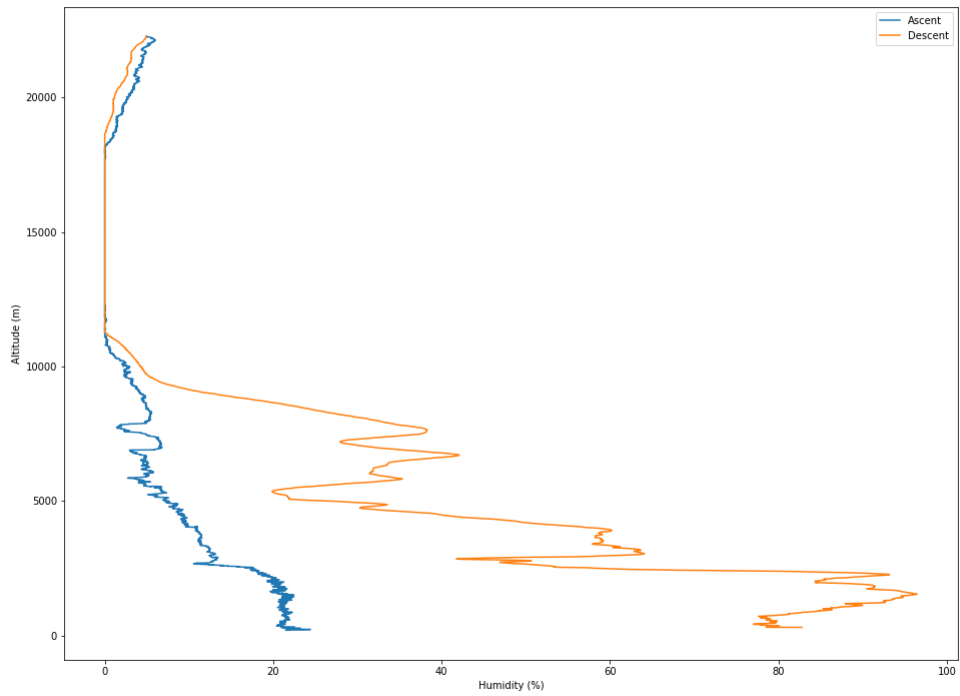
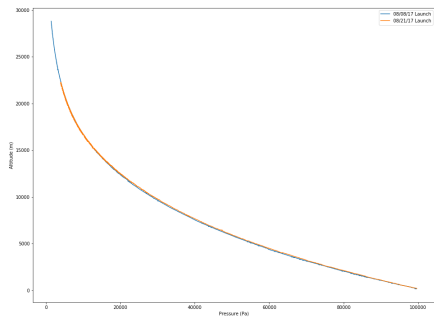
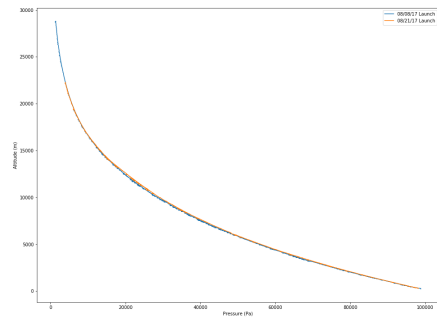

Figure B.13: Humidity measured during the 08/21 flight for ascent and descent.



(a)



(b)

Figure B.14: Comparison of the pressure measured from the BMP180 IC for both the 08/08 and 08/21 flights for (a) ascent and (b) descent. The range of the measured pressure is within the bounds of expected.

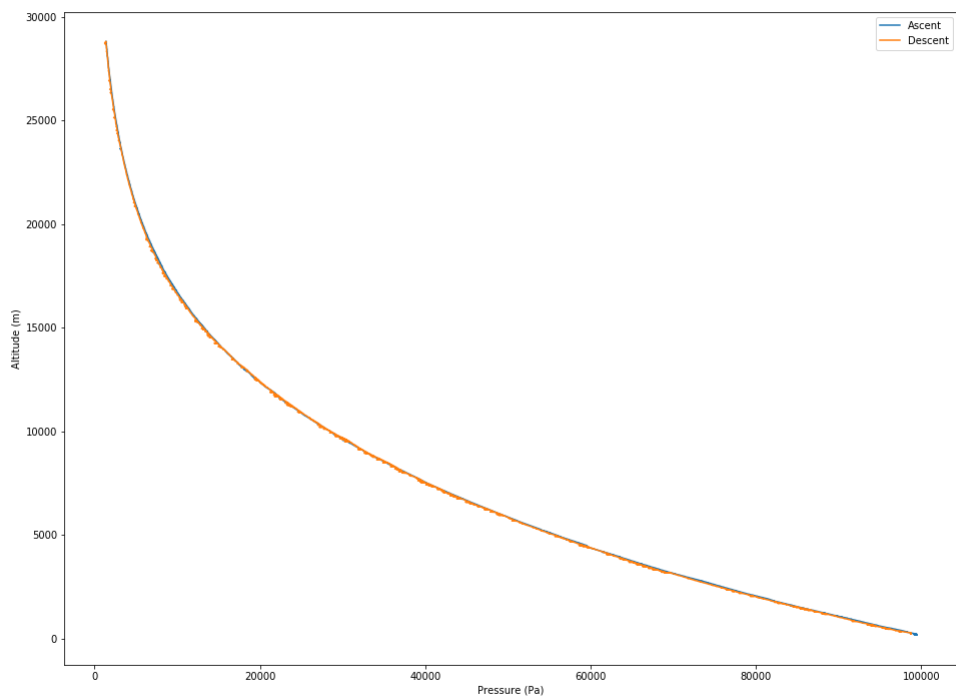

Figure B.15: Pressure measured during the 08/08 flight for ascent and descent.

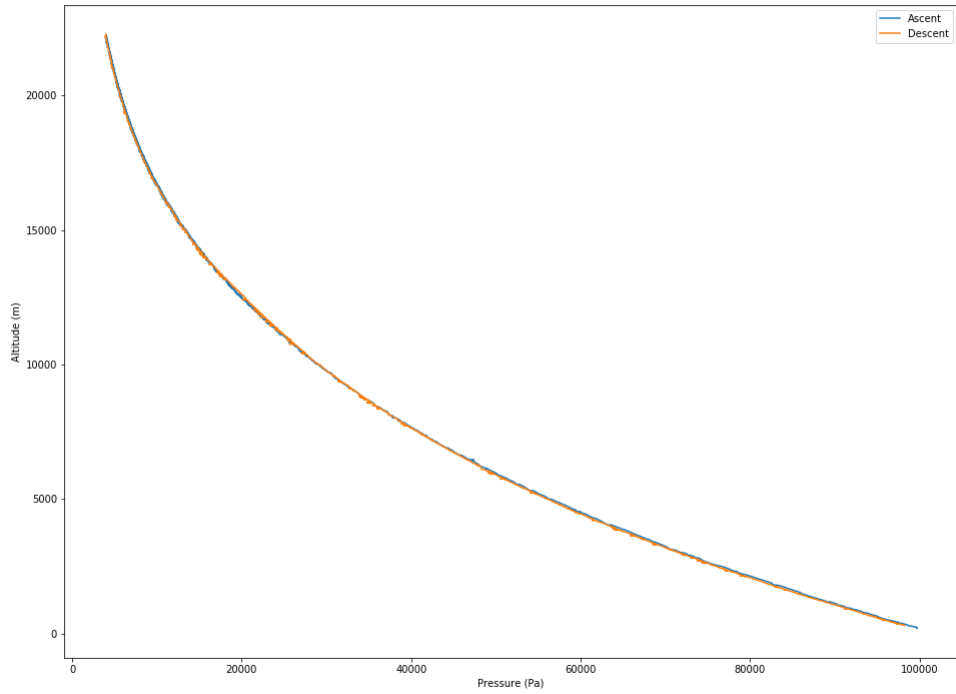

Figure B.16: Pressure measured during the 08/21 flight for ascent and descent.

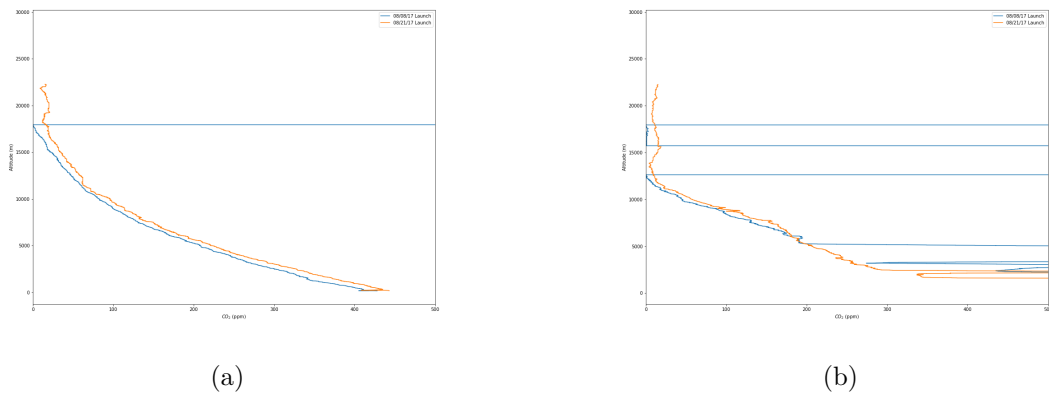
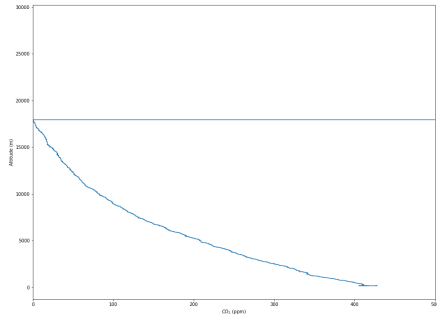
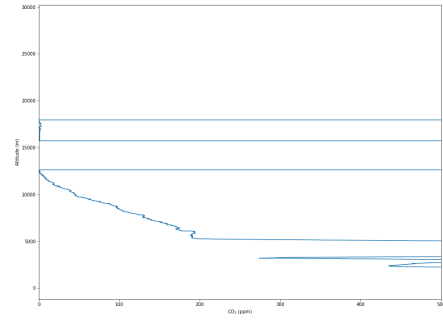

Figure B.17: Comparison of the CO_2 measured from the K-30 IC for both the 08/08 and 08/21 flights for (a) ascent and (b) descent. The k-30 seems to have malfunctioned for a majority of the of the 08/08 flight. The reasons are unknown However, descent data is questionable due to the rapid rate of descent.



(a)



(b)

Figure B.18: CO2 measured during the 08/08 flight for (a) ascent and (d) descent.

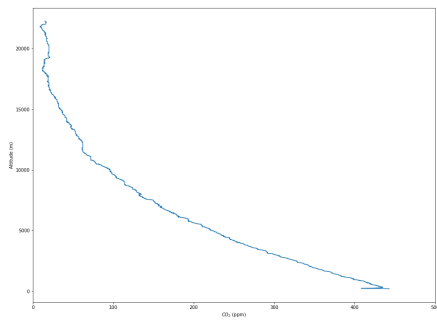

(a)

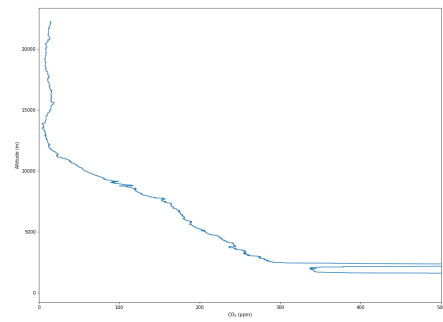

(b)

Figure B.19: CO2 measured during the 08/08 flight for (a) ascent and (d) descent.